

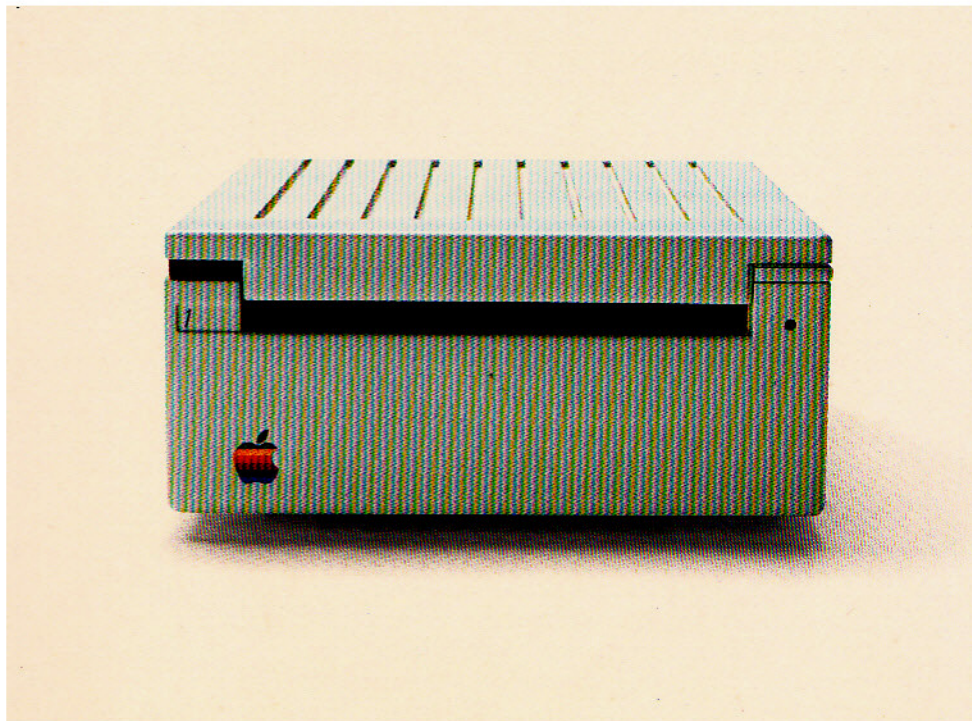

Apple® II UniDisk™ 3.5 Owner's Manual



UniDisk 3.5 Owner's Manual
UniDisk 3.5 Manuel de l'utilisateur
UniDisk 3.5 Benutzer-Handbuch
UniDisk 3.5 Manuale Utente
Manual del usuario del UniDisk 3.5

Copyright

©Copyright 1985 Apple Computer, Inc. for all nontextual material, graphics, figures, photographs, and all computer program listings or code in any form, including object and source code. All rights reserved.

Apple, the Apple logo, and UniDisk are trademarks of Apple Computer, Inc.

Printed in Japan.



UniDisk™ 3.5 Owner's Manual

Contents

UniDisk 3.5 Owner's Manual	1
Introducing the UniDisk 3.5	2
Getting Ready for Installation	3
Apple IIc Configuration	3
Apple IIe and II Plus Configuration	3
Connecting Your UniDisk 3.5 to an Apple IIc	4
Connecting Your UniDisk 3.5 to an Apple IIe	5
Installing a Second Disk Drive	8
Getting Better Acquainted	8
About 3½-Inch Disks	10
Inserting and Removing a 3½-Inch Disk	10
Write Protecting a 3½-Inch Disk	12
Care and Handling of 3½-Inch Disks	12
Caring for Your UniDisk 3.5	13
If Your UniDisk 3.5 Doesn't Work	14
Radio and Television Interference	14

Pour en savoir davantage	24
Les disquettes 3½ pouces	26
Introduire et retirer une disquette 3½ pouces	26
Protéger contre l'écriture une disquette 3½ pouces	28
Soins à apporter aux disquettes 3½ pouces	29
Soins à apporter à l'UniDisk 3.5	30
Si votre UniDisk 3.5 ne fonctionne pas	30
Parasites radio et télévision	31

UniDisk 3.5 Benutzer-Handbuch

33

Einleitung	34
Vorbereitung zum Anschluß an den Computer	35
Wenn Sie einen Apple IIc haben	35
Wenn Sie einen Apple IIe oder Apple II Plus haben	35
Anschluß an den Apple IIc	36
Anschluß an den Apple IIe	37
Anschluß eines zweiten Laufwerks	40
Bedienung der UniDisk 3.5	40
Wissenswertes über 3½-Zoll-Disketten	42
Einlegen und Auswerfen von 3½-Zoll-Disketten	42
Schreibschutz einer 3½-Zoll-Diskette	44
Pflege und Handhabung von 3½-Zoll-Disketten	44
Pflege der UniDisk 3.5	45
Falls das UniDisk 3.5-Laufwerk nicht funktioniert	46

Unidisk 3.5 Manuale Utente

47

Introduzione	48
Preparazione per l'installazione	49
Configurazione Apple IIc	49
Configurazione Apple IIe o Apple II Plus	49
Collegamento dell' UniDisk 3.5 ad un Apple IIc	50
Collegamento dell' UniDisk 3.5 ad un Apple IIe	51
Installazione di un secondo drive	54
Per saperne di più	54
Due parole sui dischi da 3½"	56
Inserimento e rimozione di un disco da 3½"	56
Protezione in scrittura di un disco da 3½"	58
Cura e manipolazione dei dischi da 3½"	59
Cura dell'UniDisk 3.5	60
Se l'UniDisk 3.5 non funziona	60
Interferenza radiotelevisiva	61

Presentación del UniDisk 3.5	64
Preparaciones para instalarlo	65
Configuración del Apple IIc	65
Configuración del Apple IIe o II Plus	65
Cómo conectar el UniDisk 3.5 a un Apple IIc	66
Cómo conectar el UniDisk 3.5 a un Apple IIe	67
Cómo instalar una segunda unidad de disco	70
Cómo familiarizarse más con el sistema	70
Acera de los discos de 3½ pulgadas	72
Cómo insertar y quitar un disco de 3½ pulgadas	72
Cómo proteger contra escritura un disco de 3½ pulgadas	74
Cómo cuidar y manejar los discos de 3½ pulgadas	74
Cómo cuidar el UniDisk 3.5	75
Si el UniDisk 3.5 no funciona	76
Interferencia en radio y televisión	76

UniDisk 3.5 Owner's Manual

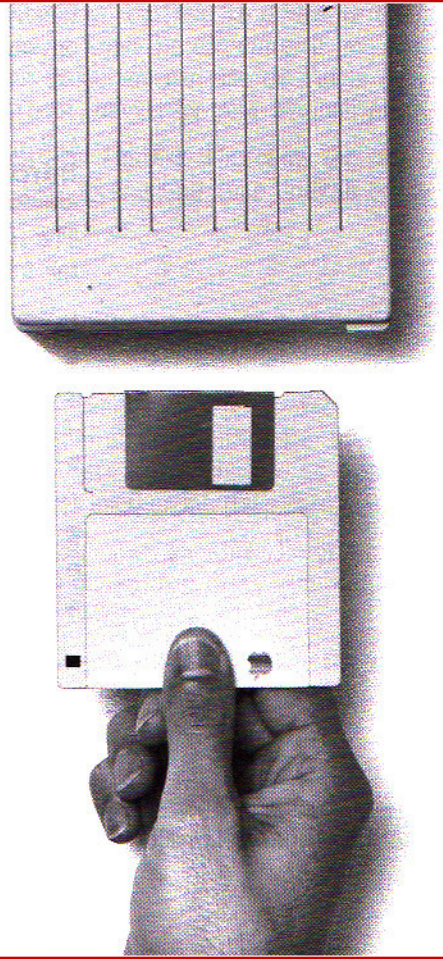

This manual will familiarize you with your new UniDisk 3.5 drive and explain how to install, operate, and care for it.

Before reading this manual or attempting to use your UniDisk 3.5, you should first read the manuals that came with your computer.

In addition to introducing you to the features of the UniDisk 3.5, this manual gives you step-by-step instructions for connecting it to your computer. This manual also instructs you in the use, care, and handling of your UniDisk 3.5 and its storage media, and gives you tips on what to do if you have a problem with your system.

Introducing the UniDisk 3.5

The unique design of your UniDisk 3.5 mass storage system includes the following features:

- Small and compact—occupies minimum work surface space.
- Low profile—only 57 millimeters (2.2 inches) high.
- Lightweight and transportable—weighs only 1.2 kilograms (2.6 pounds).
- Smaller storage media with increased storage capacity—each double-sided 3½-inch disk provides 800 kilobytes of storage.
- Low power—all operating power is supplied by the computer.
- Easy to install.
- Easy to use.

Getting Ready for Installation

You can use your UniDisk 3.5 with any Apple II computer that has at least 64 kilobytes of random-access memory (RAM).

Apple IIc Configuration

You may connect a maximum of two UniDisk 3.5 drives, or one UniDisk 3.5 and a Disk IIc, to an Apple IIc computer. If you are using programs recorded on 5¼-inch disks, you can use the Apple IIc's built-in drive as the startup (boot) device for your 5¼-inch disks.

When you are ready to install your UniDisk 3.5, follow the step-by-step instructions in the section called "Connecting Your UniDisk 3.5 to an Apple IIc."

Apple IIe or II Plus Configuration

For installation on an Apple IIe or an Apple II Plus, you need the UniDisk 3.5 interface card that comes in a separate accessory kit. The interface card supports a maximum of two UniDisk 3.5 drives. If you plan to connect more than two UniDisk 3.5 drives to an Apple IIe or an Apple II Plus, you must install another interface card.

If you plan to use your UniDisk 3.5 with an Apple IIe or Apple II Plus, and are using programs recorded on 5¼-inch disks, you will also need an Apple 5¼-inch disk drive for a startup (boot) device.

When you are ready to install your UniDisk 3.5, follow the step-by-step instructions in the section called "Connecting Your UniDisk 3.5 to an Apple IIe."

II Plus

If your computer is an Apple II Plus, you can follow the Apple IIe installation instructions, but you must first obtain a special two-part connector retaining clamp (service part 655-8112) and instructions for installing it from your dealer.

Boot is a common term for startup. It means to start up a computer by loading a program into the computer's memory and executing it to get the system running.

An interface card is a printed circuit board that you install in your computer to allow communication with an attached peripheral device such as a disk drive. It is sometimes called a *peripheral card*, or just plain *card*.

Connecting Your UniDisk 3.5 to an Apple IIc

▲Warning

Remember! You should always turn *off* the power switch on your computer and unplug the power cord before you try to connect anything to or disconnect anything from your computer; otherwise, you are likely to damage the circuits of your computer and your drive.

1. Set your computer's power switch to 0 (off) by pressing on the lower half of the switch (Figure 1) and unplug the power cord.
2. Prop up your computer on its handle as shown in Figure 2.
3. Plug the cable from your UniDisk 3.5 into the disk drive connector on the back of your computer (Figure 3) and tighten the retaining screws.

Figure 1. Turning Off the Apple IIc

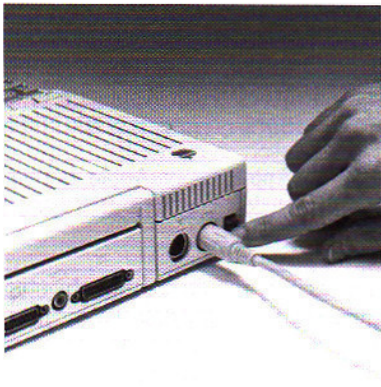

Figure 2. Propping Up the Apple IIc on Its Handle

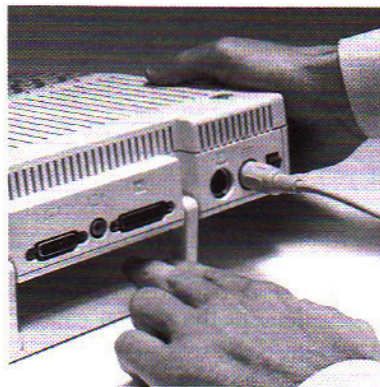
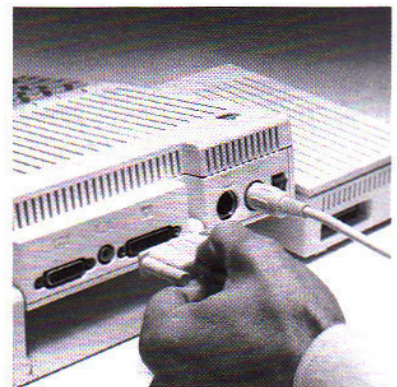

Figure 3. Plugging the UniDisk 3.5 Into the Apple IIc



4. Attach drive identification label 1 to the recess under the "in use" indicator on the front of your drive.
5. Plug in the computer's power cord.

Important!

Before you can operate your drive, you must remove the packing disk that was inserted at the factory to protect the drive mechanism during shipment. To do this, turn *on* the computer's power switch and press the eject button on the front of the drive. (See Figure 14.) Then pull out the packing disk and discard it.

Connecting Your UniDisk 3.5 to an Apple IIe

II Plus

If your computer is an Apple II Plus, you should disregard steps 1 through 5. Instead, obtain a special two-part retaining clamp (service part 655-8112) from your dealer and follow the instructions that come with it to secure the connector to the back panel of your computer.

▲Warning

Remember! You should always turn *off* the power switch on your computer and unplug the power cord before you try to connect anything to or disconnect anything from your computer; otherwise, you are likely to damage the circuits of your computer and your drive.

1. Turn *off* the power switch on the back of your computer and unplug the power cord. (See Figure 4.)
2. Carefully remove the cover from the computer and set it aside.
3. Remove the protective plastic insert from opening 3 on the back panel of your Apple IIe computer by reaching inside and pushing down and out on the plastic tab on the top of the plate. (See Figure 5.)

Figure 4. Turning Off the Apple IIe

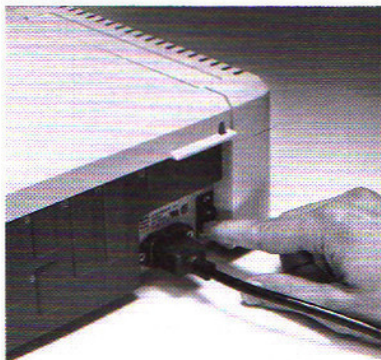

Figure 5. Removing the Cover Plate From an Apple IIe



Important!

In the following steps you will handle the UniDisk 3.5 interface card. Handle it with care. Grasp it by the corners or edges, and try not to touch the components. Don't grasp the card by the gold "fingers" on its bottom edge—they are the medium through which the computer communicates to the card and their efficiency decreases if they are dirty or scratched.

4. Remove the interface card from the accessory kit. Arrange the interface card, its ribbon-type cable, and the two jack screws as shown in Figure 6.

Figure 6. Arranging the Interface Card and Hardware

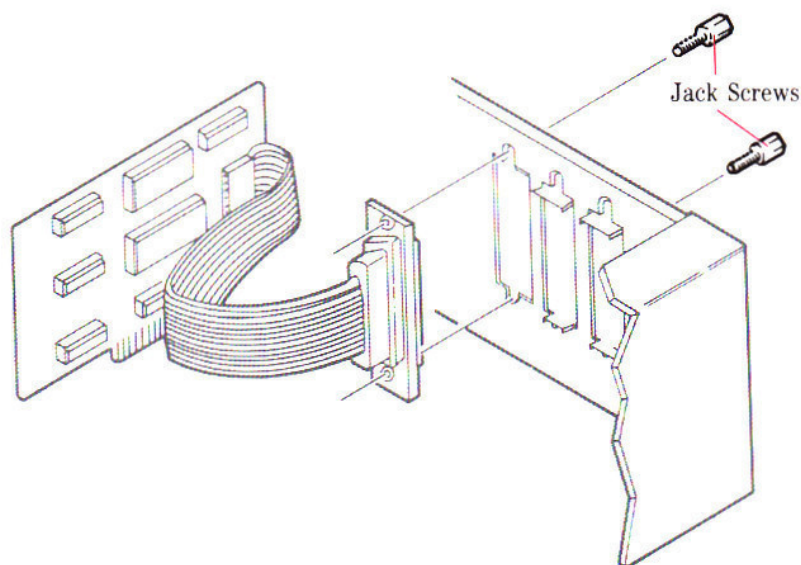
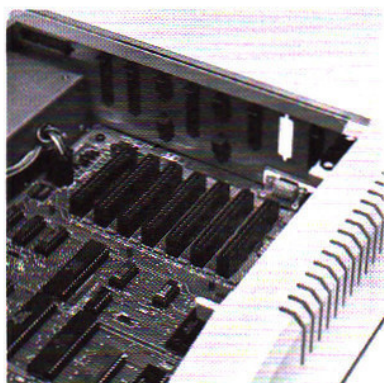

Figure 7. Card Slots



5. Hold the cable's D-shaped connector against the opening. Reach behind the computer and feed the two jack screws through the holes above and below the opening and into the threaded holes on the connector. (See Figure 6.) Use the small wrench to tighten the screws.
6. Locate the row of connectors (usually referred to as card slots) across the rear of your computer's main circuit board. Each slot is identified by a number on the circuit board. (See Figure 7.) If you are using an Apple 5¼-inch disk drive as your startup device, you have probably already installed its controller card in slot 6.

Important!

The following steps assume that you plan to use your UniDisk 3.5 only as a storage device and recommend that you install it in slot 4. You may choose another slot if slot 4 is already occupied. If you have copied programs onto your 3½-inch disks and prefer to start up your system directly from your UniDisk 3.5, you must install the UniDisk 3.5 interface card in a higher numbered slot than any other disk drive's controller card. For example, if you have a 5¼-inch drive, you can move its controller card to slot 4 and install the UniDisk 3.5 interface card in slot 6, thus making your UniDisk 3.5 the startup device.

7. Hold your interface card over slot 4 so that the side of the card on which the components are mounted is facing away from the power supply. (See Figure 8.)
8. Gently but firmly push the gold "fingers" on the card's edge connector into the slot, rear edge first. Then push the front edge down and gently rock the card back and forth until it is level and firmly seated.
9. Slide the computer's top cover into position and press down on the rear corner fasteners until they pop into place.
10. Plug the cable from your UniDisk 3.5 into the D-shaped connector that you just installed on the back panel of your computer and tighten the retaining screws. (See Figure 9.)

Figure 8. Installing the Interface Card in an Apple IIe



Figure 9. Plugging the UniDisk 3.5 Into an Apple IIe

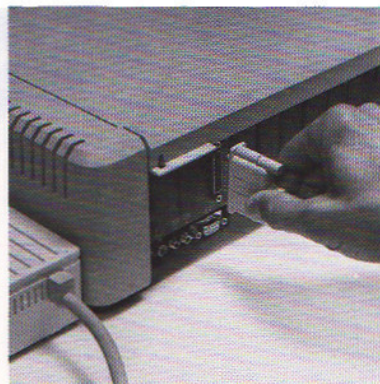

11. Attach drive identification label 1 to the recess under the “in use” indicator on the front of your drive.
12. Plug in the computer's power cord.

Important!

Before you can operate your drive, you must remove the packing disk that was inserted at the factory to protect the drive mechanism during shipment. To do this, turn *on* your computer's power switch, push the eject button on the front of your drive, pull out the packing disk, and discard it. (See Figure 14.)

Installing a Second Disk Drive

Daisy chain means to connect devices, such as disk drives, together in an interlinked series.

Figure 10. Connecting a Second Disk Drive

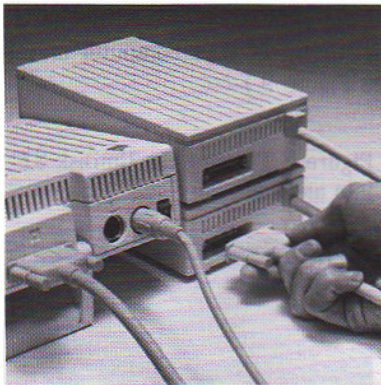

You may connect a second disk drive to your first UniDisk 3.5. The second drive must be connected to the first in daisy-chain fashion.

If your computer is an Apple IIe, your second drive must also be a UniDisk 3.5. However, if you have an Apple IIc, your second drive can be either a UniDisk 3.5 or an Apple Disk IIc.

To connect the second drive, follow these steps:

1. Plug the cable from your second drive into the connector on the back of the first UniDisk 3.5. (See Figure 10.)
2. Tighten the retaining screws on the drive cable connector.
3. Attach identification label 2 to the recess under the “in use” indicator on the front of your second disk drive.
4. Remove the packing disk from your drive and discard it as you did when installing your first UniDisk 3.5.

Getting Better Acquainted

You're now ready to use your UniDisk 3.5, but before you do, we recommend that you read through the rest of this manual to learn a little more about your drive and its disks.

The UniDisk 3.5 is a very small, but powerful, mass storage system. Your UniDisk 3.5 has no operating controls, but it does have a red “in use” indicator light (Figure 11) that comes on whenever the drive is running.

You can use your UniDisk 3.5 with either the ProDOS or Pascal 1.3 operating system. The computer uses the operating system to automatically keep track of files, store and retrieve information, and do many other housekeeping tasks. For a complete understanding of the operating system you are using, refer to the manuals that accompany your operating system software.

Important !

The disk formatter utility included in some application programs will not format 3½-inch disks. If you have an Apple IIc, you can use your *System Utilities* disk to format your 3½-inch disks, and to copy programs and transfer files from 5¼-inch disks to 3½-inch disks. Apple IIe and Apple II Plus owners can use their *ProDOS User's Disk* to do these tasks.

Figure 11. The Front of the UniDisk 3.5

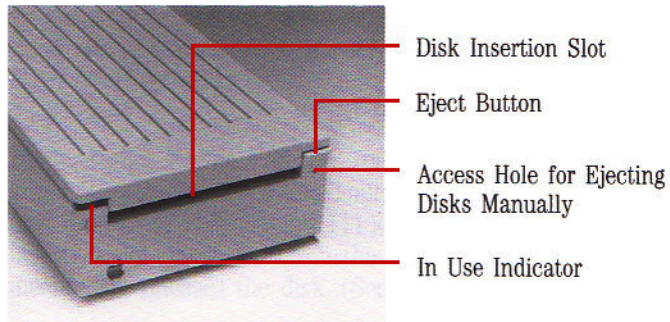

About 3½-Inch Disks

Your UniDisk 3.5 uses removable, double-sided 3½-inch disks. Each disk can store up to 800 kilobytes of formatted data. The disk is enclosed in a rectangular cartridge. (See Figure 12.) The cartridge protects the disk and contains lubricants that keep the disk clean and allow it to spin freely. The cartridge has a mechanical shutter that closes automatically to protect the recording surface when the disk is not in the drive.

Figure 12. The 3½-Inch Disk

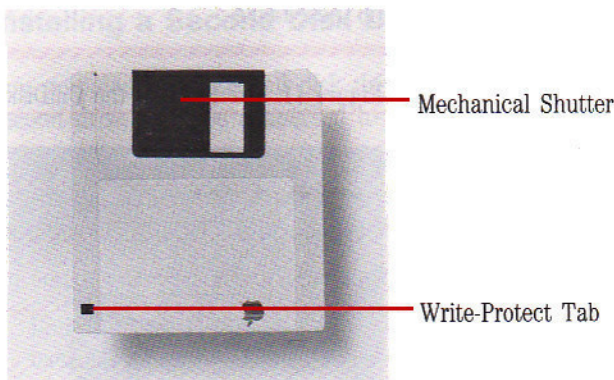

Inserting and Removing a 3½-Inch Disk

1. Gently insert your disk into the slot on the front of your drive, shutter end first, label side up. (See Figure 13.) When the disk is nearly all the way in, the drive's internal mechanism will automatically lock it into place.
2. To remove a 3½-inch disk, first push in on the eject button. (See Figure 14.) Next, grasp the disk and carefully pull it out of the slot.

Figure 13. Inserting a 3½-Inch Disk

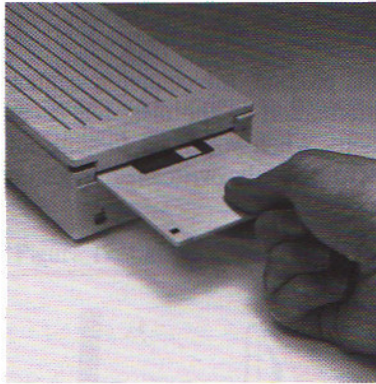
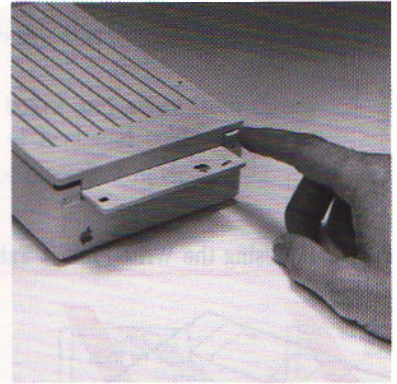

Figure 14. Ejecting a 3½-Inch Disk



Important!

You can eject a 3½-inch disk only when the computer is on and the drive's "in use" light is off. This feature prevents accidental loss of data.

In Case of a Power Failure: You can remove a disk from your drive manually using a straightened-out paper clip or similar object. Insert it into the access hole (Figure 11) located to the right of the disk insertion slot. Push gently on the paper clip until the mechanical eject mechanism releases the disk. (See Figure 15.)

Figure 15. Ejecting a 3½-Inch Disk Manually

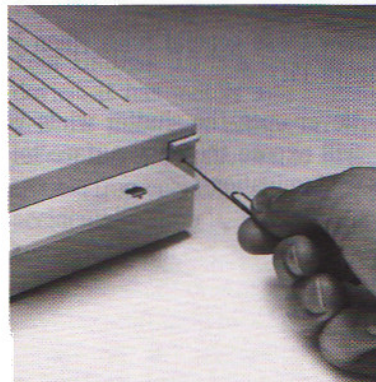

Write Protecting a 3½-Inch Disk

The write-protect tab allows you to protect information that is stored on the disk. To write protect your disk, simply turn it over and slide the tab toward the back edge as shown in Figure 16. With the tab in this position, the computer cannot change information or write new information on the disk, but it can read any information that is already there. When you want to store information on the disk, slide the tab forward to the write-enable position.

Figure 16. Using the Write-Protect Tab

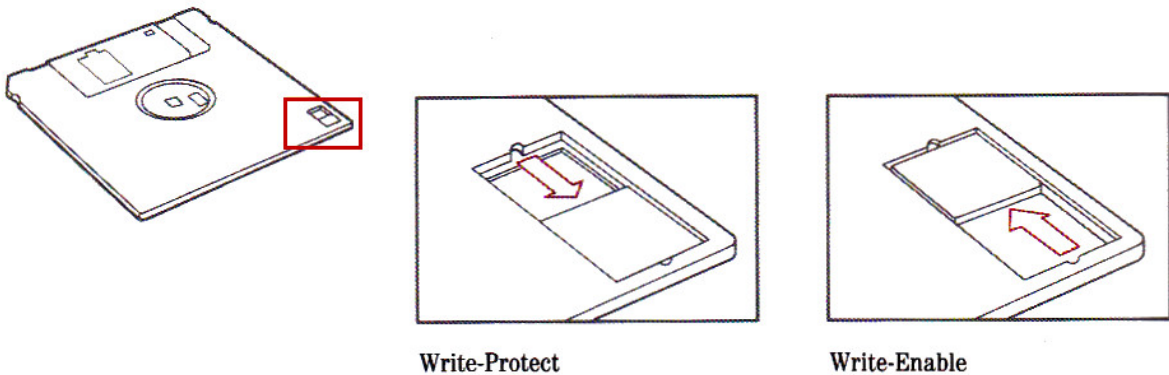

Care and Handling of 3½-Inch Disks

Follow these general rules when handling 3½-inch disks. (See Figure 17.)

- Never open the shutter while your disk is out of the drive. Doing so will expose the data surface to dirt, dust, fingerprints, and other contamination.

- Use a *felt tip* pin to write on a label already attached to the disk. Do not use an eraser on the label. Eraser dust is abrasive and can damage the disk.
- Do not place disks on dirty or greasy surfaces; do not let them collect dust.
- Store disks upright in protective boxes and away from direct sunlight, moisture, and extremes of heat and cold.
- Keep disks away from magnets or electrical devices.

Figure 17. Care and Handling of 3½-Inch Disks

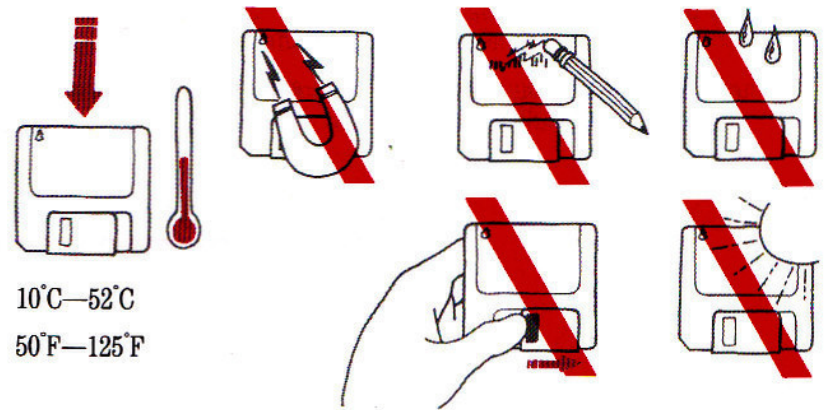

Caring For Your UniDisk 3.5

Your UniDisk 3.5 is a precision, electro-mechanical, magnetic storage device. It has motors and moving parts; therefore it is somewhat more delicate than your computer. We aligned and tested your UniDisk 3.5 before it left the factory to make sure that it would give you trouble-free operation. However, you can cause serious damage if you accidentally drop it, jar it sharply, or plug it in or unplug it when the computer is on.

If Your UniDisk 3.5 Doesn't Work

If you try to use your UniDisk 3.5 but it does not work, make sure that

- You have plugged the cable from the UniDisk 3.5 into the computer.
- You have plugged your computer's power cord into a wall outlet.
- You have turned on your computer and its green power indicator is on.
- You have correctly inserted a 3½-inch disk into your UniDisk 3.5.
- You are using the appropriate program instructions to write data to or read data from your drive.

If your UniDisk 3.5 still doesn't work, contact your dealer.

Do not attempt to open your UniDisk 3.5; this will void your warranty.

Radio and Television Interference

The equipment described in this manual generates and uses radio-frequency energy. If it is not installed and used properly—that is, in strict accordance with our instructions—it may cause interference with radio and television reception.

This equipment has been tested and complies with the limits for a Class B computing device in accordance with the specifications in Subpart J, Part 15, of FCC rules. These rules are designed to provide reasonable protection against such interference in a residential installation. However, there is no guarantee that the interference will not occur in a particular installation, especially if a "rabbit ear" television antenna is used. (A "rabbit ear" antenna is the telescoping-rod type usually contained on television receivers.)

You can determine whether your computer is causing interference by turning it off. If the interference stops, it was probably caused by the computer or its peripherals. To further isolate the problem, disconnect the peripheral devices and their input/output cables one at a time. If the interference stops, it was caused by either the peripheral device or the I/O cable. These devices usually require shielded I/O cables. For Apple peripherals, you can obtain the proper shielded cable from your dealer. For non-Apple peripheral devices, contact the manufacturer or dealer for assistance.

If your computer does cause interference to radio or television reception, you can try to correct the interference by using one or more of the following measures:

- Turn the television or radio antenna until the interference stops.
- Move the computer to one side or the other of the television or radio.
- Move the computer farther away from the television or radio.
- Plug the computer into an outlet that is on a different circuit than the television or radio. (That is, make certain the computer and the radio or television set are on circuits controlled by different circuit breakers or fuses.)
- Consider installing a rooftop television antenna with coaxial cable lead-in between the antenna and television.

If necessary, you should consult your Apple-authorized dealer or an experienced radio/television technician for additional suggestions.

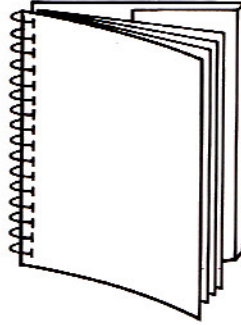

Tuck end flap inside back cover when using manual.

Rabattre le volet à l'intérieur de la couverture pendant que le manuel est ouvert.

Beim Gebrauch des Handbuchs diese Seite umschlagen.

Ripiegare questo lembo all'interno quando si usa il manuale.

Doble la carátula posterior hacia adentro cuando vaya a emplear el manual.



Apple Computer, Inc.
20525 Mariani Avenue
Cupertino, California 95014
408 996-1010
TLX 171-576

030-1151-B
©1985, Apple Computer, Inc.
Printed in Japan 3-760-841-11