

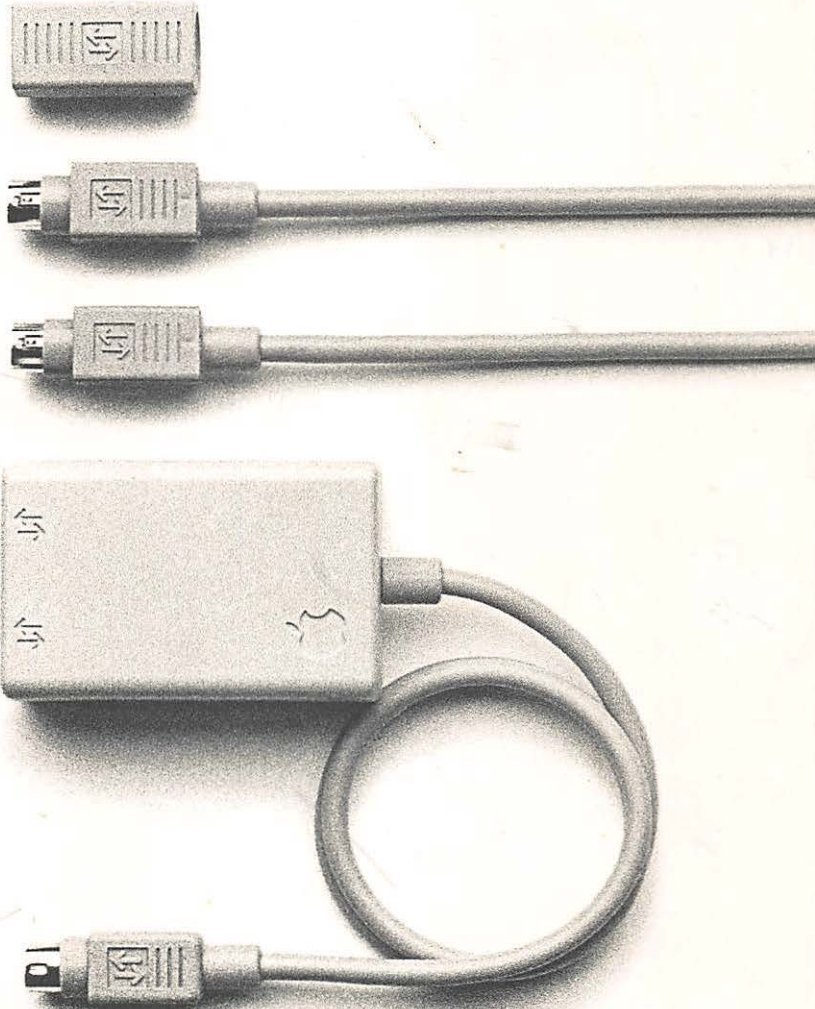

LocalTalk™ Cable System Owner's Guide*



*Replaces the AppleTalk® Personal Network Guide

LIMITED WARRANTY ON MEDIA AND REPLACEMENT

If you discover physical defects in the manuals distributed with an Apple product or in the media on which a software product is distributed, Apple will replace the media or manuals at no charge to you, provided you return the item to be replaced with proof of purchase to Apple or an authorized Apple dealer during the 90-day period after you purchased the software. In addition, Apple will replace damaged software media and manuals for as long as the software product is included in Apple's Media Exchange Program. While not an upgrade or update method, this program offers additional protection for up to two years or more from the date of your original purchase. See your authorized Apple dealer for program coverage and details. In some countries the replacement period may be different; check with your authorized Apple dealer.

ALL IMPLIED WARRANTIES ON THE MEDIA AND MANUALS, INCLUDING IMPLIED WARRANTIES OF MERCHANTABILITY AND FITNESS FOR A PARTICULAR PURPOSE, ARE LIMITED IN DURATION TO NINETY (90) DAYS FROM THE DATE OF THE ORIGINAL RETAIL PURCHASE OF THIS PRODUCT.

Even though Apple has tested the software and reviewed the documentation, **APPLE MAKES NO WARRANTY OR REPRESENTATION, EITHER EXPRESS OR IMPLIED, WITH RESPECT TO SOFTWARE, ITS QUALITY, PERFORMANCE, MERCHANTABILITY, OR FITNESS FOR A PARTICULAR PURPOSE. AS A RESULT, THIS SOFTWARE IS SOLD "AS IS," AND YOU THE PURCHASER ARE ASSUMING THE ENTIRE RISK AS TO ITS QUALITY AND PERFORMANCE.**

IN NO EVENT WILL APPLE BE LIABLE FOR DIRECT, INDIRECT, SPECIAL, INCIDENTAL, OR CONSEQUENTIAL DAMAGES RESULTING FROM ANY DEFECT IN THE SOFTWARE OR ITS DOCUMENTATION, even if advised of the possibility of such damages. In particular, Apple shall have no liability for any programs or data stored in or used with Apple products, including the costs of recovering such programs or data.

THE WARRANTY AND REMEDIES SET FORTH ABOVE ARE EXCLUSIVE AND IN LIEU OF ALL OTHERS, ORAL OR WRITTEN, EXPRESS OR IMPLIED. No Apple dealer, agent, or employee is authorized to make any modification, extension, or addition to this warranty.

Some states do not allow the exclusion or limitation of implied warranties or liability for incidental or consequential damages, so the above limitation or exclusion may not apply to you. This warranty gives you specific legal rights, and you may also have other rights which vary from state to state.

WARNING

This equipment has been certified to comply with the limits for a Class B computing device, pursuant to Subpart J of Part 15 of FCC rules. See instructions if interference to radio or television reception is suspected.



Apple®



LocalTalk™ Cable System Owner's Guide

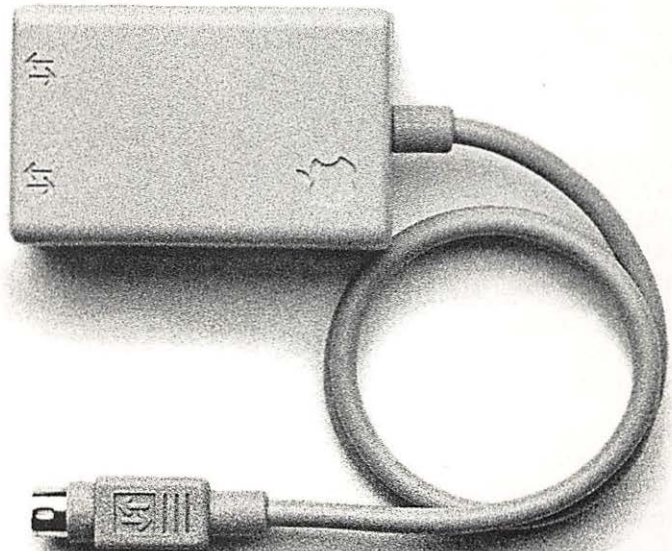

 APPLE COMPUTER, INC.

This manual and the software described in it are copyrighted, with all rights reserved. Under the copyright laws, this manual or the software may not be copied, in whole or part, without written consent of Apple, except in the normal use of the software or to make a backup copy of the software. The same proprietary and copyright notices must be affixed to any permitted copies as were affixed to the original. This exception does not allow copies to be made for others, whether or not sold, but all of the material purchased (with all backup copies) may be sold, given, or loaned to another person. Under the law, copying includes translating into another language or format.

You may use the software on any computer owned by you, but extra copies cannot be made for this purpose.

© Apple Computer, Inc., 1987
20525 Mariani Ave.
Cupertino, California 95014
(408) 996-1010

Apple, the Apple logo, AppleTalk, ImageWriter, LaserWriter, and Macintosh are registered trademarks of Apple Computer, Inc.

AppleShare, Apple IIGS, and LocalTalk are trademarks of Apple Computer, Inc.

ITC Avant Garde Gothic, ITC Garamond, and ITC Zapf Dingbats are registered trademarks of International Typeface Corporation.

Microsoft is a registered trademark of Microsoft Corporation.

POSTSCRIPT is a registered trademark of Adobe Systems Incorporated.

Teflon is a registered trademark of DuPont.

Simultaneously published in the United States and Canada.



Contents

Figures v

Radio and television interference vi

Chapter 1 About LocalTalk 1

What's in a connector kit 3

Other LocalTalk products 4

Chapter 2 Network Know-How 7

Place cables safely 8

Always a line, never a circle 9

No unattached cables 10

Use the printer port 11

Turn devices off before you attach them 11

Chapter 3 Installing a Network Using LocalTalk Cables 13

Chapter 4 Altering an Existing Network 19

Adding a device to the end of a network 20

Adding a device between two connector boxes 21

 With a new connector box and one cable 21

 With a new connector box, two cables, and a cable extender 23

Removing a device from a network 24

Moving a device 26

Chapter 5	Troubleshooting	27
Appendix	LocalTalk Information	31
	LocalTalk ordering information	31
	Developers' information	32
	LocalTalk specifications	32
	Glossary	33

Figures

Chapter 1 About LocalTalk 1

- Figure 1-1 Ports and connector box cable plugs 3
- Figure 1-2 LocalTalk connector kits 4

Chapter 2 Network Know-How 7

- Figure 2-1 Do not create a circular network 9
- Figure 2-2 You need only one cable to connect two devices 10
- Figure 2-3 End the network with a connector box 10
- Figure 2-4 Printer ports 11

Chapter 3 Installing a Network Using LocalTalk Cables 13

- Figure 3-1 A typical network 14
- Figure 3-2 Positioning cables and connector boxes 15
- Figure 3-3 Plugging cables into connector boxes 16
- Figure 3-4 Connecting to a Macintosh Plus 17
- Figure 3-5 Connecting to an Apple IIGS 17
- Figure 3-6 An installed network 18

Chapter 4 Altering an Existing Network 19

- Figure 4-1 Adding a device to the end of a network 21
- Figure 4-2 Plugging the new cable into the connector boxes 22
- Figure 4-3 Attaching the new connector box to the network and to the new device 22
- Figure 4-4 Attaching the new cables to the new connector box 23
- Figure 4-5 Attaching the network cables to the cable extender 24
- Figure 4-6 Disconnecting the device from the connector box 24
- Figure 4-7 Unplugging the connector box 25
- Figure 4-8 Attaching the network cables to the cable extender 26

Chapter 5 Troubleshooting 27

- Figure 5-1 The network should end with a connector box 29

Radio and television interference

The equipment described in this manual generates and uses radio-frequency energy. If it is not installed and used properly—that is, in strict accordance with Apple's instructions—it may cause interference with radio and television reception.

This equipment has been tested and complies with the limits for a Class B computing device in accordance with the specifications in Subpart J, Part 15, of FCC rules. These rules are designed to provide reasonable protection against such interference in a residential installation. However, there is no guarantee that the interference will not occur in a particular installation, especially if a "rabbit-ear" television antenna is used. (A rabbit-ear antenna is the telescoping-rod type usually found on television receivers.)

You can determine whether your computer is causing interference by turning it off. If the interference stops, it was probably caused by the computer or its peripheral devices.

If your computer system does cause interference to radio or television reception, you can try to correct the interference by using one or more of the following measures:

- Turn the television or radio antenna until the interference stops.
- Move the computer to one side or the other of the television or radio.
- Move the computer farther away from the television or radio.
- Plug the computer into an outlet that is on a different circuit than the television or radio. (That is, make certain the computer and the radio or television are on circuits controlled by different circuit breakers or fuses.)
- Consider installing a rooftop television antenna with a coaxial cable lead-in between the antenna and the television.

If necessary, consult your authorized Apple dealer or an experienced radio/television technician for additional suggestions.

You may find helpful the following booklet, prepared by the Federal Communications Commission: "How to Identify and Resolve Radio-TV Interference Problems." This booklet is available from the U.S. Government Printing Office, Washington, DC 20402.

Important

This product was FCC-certified under test conditions that included use of shielded cables and connectors between system components. It is important that you use shielded cables and connectors to reduce the possibility of causing interference to radios, television sets, and other electronic devices. For Apple peripheral devices, you can obtain the proper shielded cable from your authorized Apple dealer. For non-Apple peripheral devices, contact the manufacturer or dealer for assistance.



Chapter 1

About LocalTalk

LocalTalk™ cables and connectors allow you to connect your computer to other computers and peripheral devices in an AppleTalk® network system. An AppleTalk network system has three components: a cable system that links devices; software, built into every Macintosh® and Apple® IIGS™ computer, that supports the network; and optional services—such as Apple’s LaserWriter® printers and AppleShare™ file servers—that networked devices can share. This guide discusses the first component—the cable system.

❖ *AppleTalk cables:* LocalTalk cables were once called *AppleTalk Personal Network cables*. The name was changed to distinguish the AppleTalk network architecture, which operates with a variety of cables, from one type of cable.

LocalTalk can support as many as 32 devices, including computers, printers, and file servers. You can exchange information between devices at speeds up to 230,400 bits per second—that’s almost 200 times faster than the data transfer rate between devices using 1200 baud modems.

This guide shows you how to set up a network and how to add to and change the network once you’ve set it up. When you’ve assembled your network, you can use network services that are designed to be part of an AppleTalk system, such as LaserWriter printers and AppleShare file servers. Refer to the manual that comes with a software package (such as an electronic mail program) or with a particular piece of equipment you’ll be using on your network (such as a LaserWriter printer) for instructions on using that program or device in a network environment.

❖ *Terminology:* As you read this booklet, you will see terms in the text that appear in **boldface**. These terms are included in the glossary at the back of the book.

What's in a connector kit

Apple offers two LocalTalk kits. These kits are alike, with the exception of the type of plug (attached by a short cable to the connector box) used for connecting to the appropriate port on your computer, printer, or file server. (See Figure 1-1.)

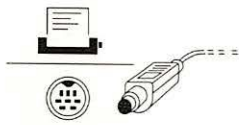

8-pin mini-circular port and plug

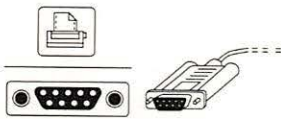

9-pin port and plug

Figure 1-1
Ports and connector
box cable plugs

- The LocalTalk Locking Connector Kit—Din-8 (see Figure 1-2) terminates in an **8-pin mini-circular plug**. Use this kit for a variety of Apple computers, including the Apple IIGS, the Macintosh Plus, the Macintosh SE, and the Macintosh II, and for the ImageWriter® II printer with the LocalTalk Option.
- The LocalTalk Locking Connector Kit—DB-9 (see Figure 1-2) terminates in a **9-pin plug**. Use this kit for Macintosh 128K, 512K, and 512K enhanced computers.
- ❖ *Other devices:* If the device you want to connect isn't listed here, ask your authorized Apple dealer which connector kit you need.

In addition to this booklet, each kit contains

- a LocalTalk **connector box** (a box with a short, built-in cable called the **connector box cable**)
- a 2-meter LocalTalk **cable** (a shielded cable that attaches one connector box to the next on the network)
- a LocalTalk **cable extender** (an adapter through which you can join two cables to form a longer cable, or leave a place to add a LocalTalk connector box later)

Important Make sure your connector box cable has the correct plug for the device you want to connect to. If the cable terminates in the wrong plug, see your authorized Apple dealer.

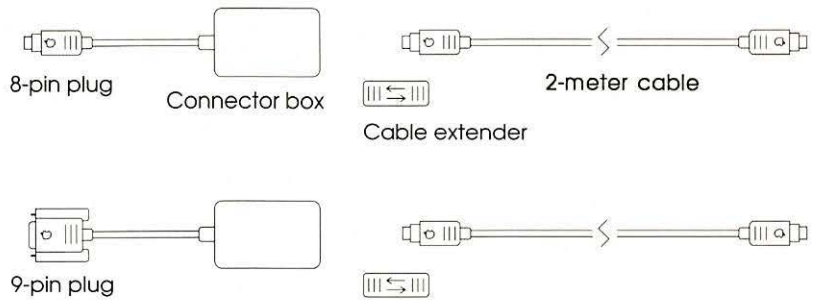

Figure 1-2
LocalTalk connector kits

Other LocalTalk products

One LocalTalk Locking Connector Kit (either Din-8 or DB-9) is all you need in order to attach a computer, printer, or file server to an existing network. Depending on how many pieces of equipment you're attaching to your network and the distances between them, however, you may need to purchase other LocalTalk products to complete your network. (Three of these products are described in the following list.) Do not substitute non-Apple cables or components.

- The *LocalTalk Locking Cable Kit—10-Meter* contains one 10-meter cable and one cable extender. The cable kit lets you connect pieces of equipment that are not close together. For example, you can attach a computer to a printer across the room.
- The *LocalTalk Locking Cable Kit—25-Meter* contains one 25-meter cable and one cable extender. Like the 10-meter kit, the 25-meter kit lets you connect pieces of equipment that are not close together.

- The *LocalTalk Custom Wiring Kit* contains 100 meters (approximately 330 feet) of shielded cable and the necessary assembled plugs, cable splicers, and cable extenders. The custom wiring kit allows you to create custom-length cables and to run LocalTalk cables through walls or suspended ceilings without the use of conduit (subject to local building codes).
- The *LocalTalk PC Card* lets you connect an MS-DOS computer to a LocalTalk-based AppleTalk network.



Chapter 2



Network Know-How

Before you assemble and use your network, you'll need to know some basic concepts and simple rules.

Place cables safely

When you install your network, be sure to follow common sense safety rules and to check local building and fire codes for correct installation standards. In some areas, if you intend to run cables through ceilings or walls, you may need to have a professional electrician install your network.

Here are some safety precautions you need to keep in mind when you install your LocalTalk cables:

- Don't place cables where someone might trip over them.
- Don't place cables where they may be repeatedly stepped on; they might deteriorate.
- Don't place LocalTalk cables outdoors.
- Don't run LocalTalk 2-, 10-, or 25-meter cables through walls or suspended ceilings unless through conduit.

Apple 2-, 10-, and 25-meter cables are designed to be routed along baseboards and under furniture and partitions. If you must run your network cable through walls or ceilings, the cables *must* go through metal conduit. The LocalTalk Custom Wiring Kit, however, uses Teflon-shielded cable that can be run through suspended ceilings and walls without conduit. Check local building or fire codes regarding the use of conduit.

Always a line, never a circle

LocalTalk is a **bus** network. This means that the network is linear, with as many zigs and zags as you like, but never joined together as a circle and never T-shaped. (See Figure 2-1.) On a bus network, information is sent out from a device through the LocalTalk connector box and broadcast through both cables attached to the box. When the information reaches the end of the network, the connector box on each end absorbs and terminates the signal. Making the network circular would mean that the signal would eventually run into itself; such a “collision” contradicts network design principles and won’t allow the network to work correctly.

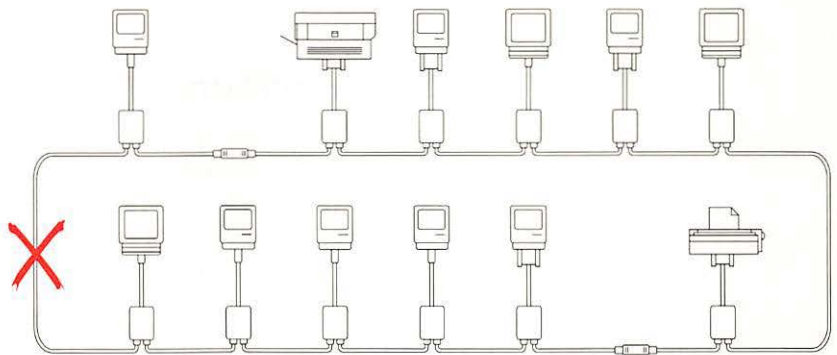

Figure 2-1
Do not create a circular network

If your network consists of only two devices, such as a Macintosh and a LaserWriter, you should have a connector kit for each device. When you connect the devices, *use only one cable*. Using both cables included in the connector kits would create a circle. (See Figure 2-2.) Coiling cables if you have extra length does not create a circle.

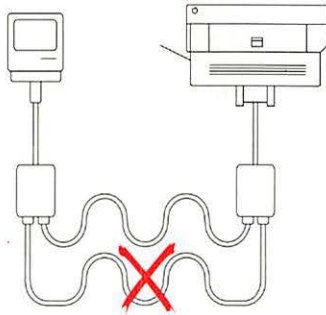

Figure 2-2
You need only one cable to connect two devices

No unattached cables

When you reach the end of the line—that is, when there are no more devices to connect—the last connector box should have one empty outlet. If a LocalTalk cable is attached to a connector box but not to anything else, the network lacks an endpoint and won't work properly. (See Figure 2-3.)

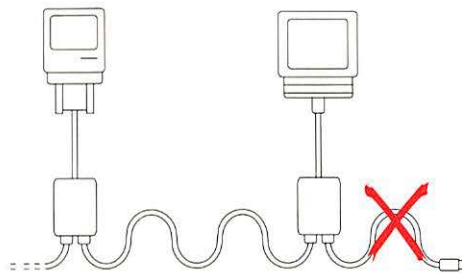
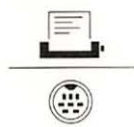
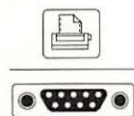

Figure 2-3
End the network with a connector box



Apple IIGS
Macintosh Plus
Macintosh SE
Macintosh II



Macintosh 128K
Macintosh 512K
Macintosh 512K enhanced

Figure 2-4
Printer ports

Use the printer port

You must plug the connector box cable into your computer's printer port. (See Figure 2-4.) If another device already occupies the printer port, you'll need to attach that device to the modem port instead. When you make a port change, you may need to make software changes on the current startup disk. See the owner's guide for your peripheral device or computer for details.

- ❖ *Macintosh owners:* If you physically disconnect the LocalTalk connector box cable from your computer, you must also deactivate the AppleTalk option:
 - If you have a version of the Finder earlier than version 5.1, use the Choose Printer desk accessory to disconnect AppleTalk; you may also need to reset the port for use with another device. As an alternative, you can use a startup disk that doesn't have a network device (such as the LaserWriter) installed.
 - If you have Finder version 5.1 or 5.3 and you've set up your startup disk with the Installer program, use the Chooser to select ports and a printer. Then open the Control Panel and click the AppleTalk Disconnected button.
 - If you have Finder version 5.4 or a later version, choose Chooser from the Apple menu and click the AppleTalk Inactive button.

Turn devices off before you attach them

To ensure proper network operation, be sure each device you add to a network is turned off before you plug in the LocalTalk connector box cable. If a device is switched on when you attach it to a network, it will immediately assign itself an identification number—without waiting to learn whether another device already has the same number. Duplication of numbers is rare, but when it happens, neither device can be used on the network until one of them is switched off and on again.



Chapter 3



Installing a Network Using LocalTalk Cables

Setting up a network should be easy and trouble free—if you follow the network rules described in Chapter 2. When you install a new network, you may want to set it up with future growth in mind. To avoid rerouting wires and making extra trips to the dealer later, you can install LocalTalk connector boxes in places where you'll need them in the future. Or you can place a cable extender between two cables and replace the cable extender with a LocalTalk connector box later.

Figure 3-1 shows an example of a proposed customer support network. As you can see, different types of devices can appear at any position in the network. Printers can be interspersed with computers, and Macintosh computers can be interspersed with Apple II computers.

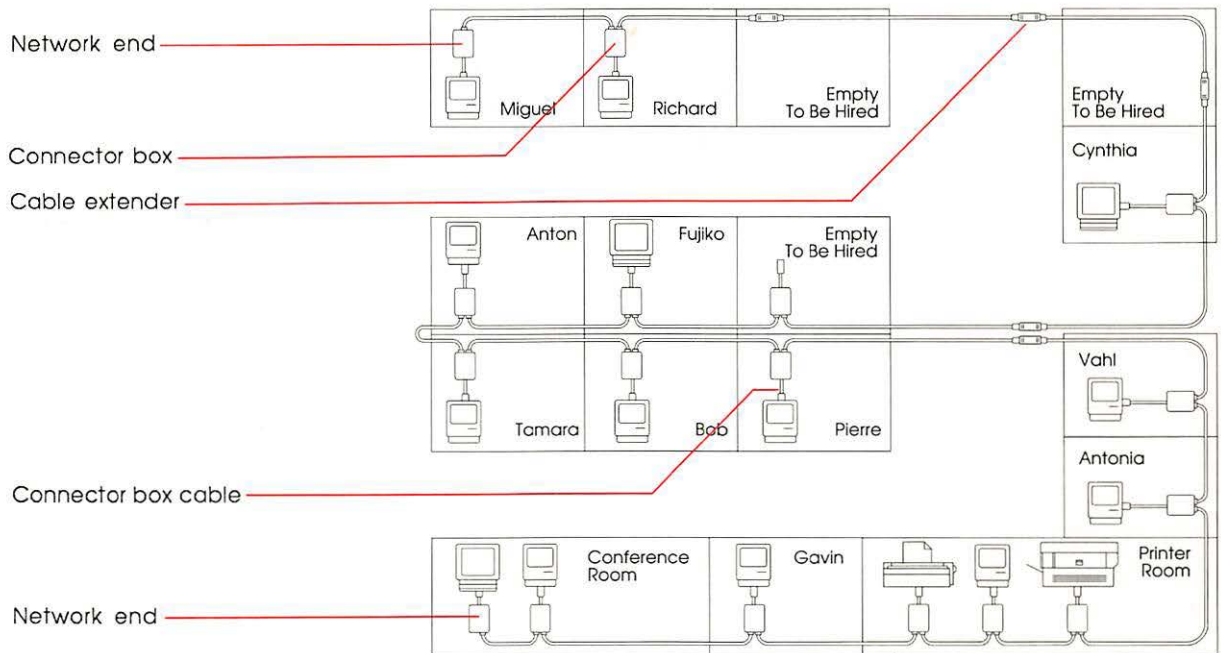

Figure 3-1
A typical network

Some cables are not recommended for use through walls and suspended ceilings unless run through conduit. See "Place Cables Safely" in Chapter 2.

The following instructions assume that your devices are already set up at their permanent locations.

■ **Determine how many cables and connector kits you need.**

You'll need one connector kit per device. Be sure to get the appropriate plug for each device; for example, you'll want a 9-pin plug for a Macintosh 512K, an 8-pin mini-circular plug for a Macintosh Plus or an ImageWriter II. (For a list of which plug to use with which Apple computer or printer, see "What's in a Connector Kit" in Chapter 1.) Each connector kit contains a 2-meter cable; if your devices are more than 2 meters apart, you'll need to purchase extra 10-meter or 25-meter cables (available in either the 10-meter or the 25-meter locking cable kit). If you need cables of varying lengths, you can combine 2-, 10-, and 25-meter cables with the cable extenders included with each connector kit and cable kit.

You may wish to measure distances and draw a floor plan to determine exactly how many cables you'll need.

■ **Lay out the cables, connector boxes, and cable extenders.**

Run the ends of the cables to each device you will include on the network, but do not plug the cables into the connector boxes, or the connector boxes into the devices. (See Figure 3-2.)

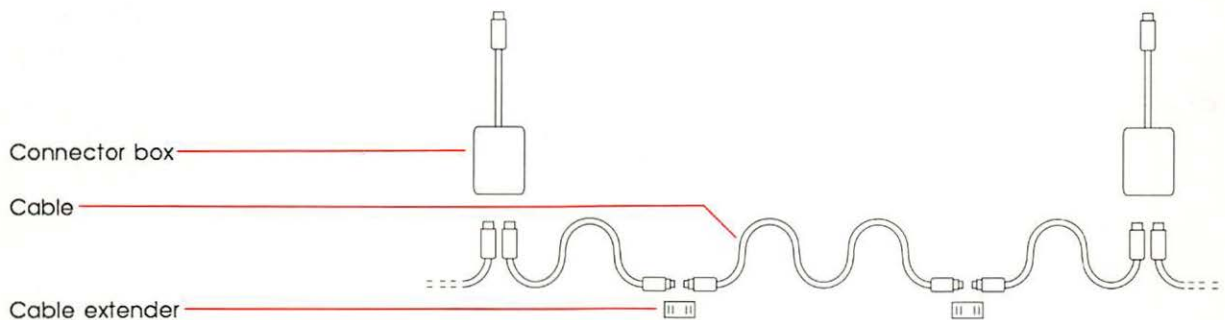

Figure 3-2
Positioning cables and connector boxes

- **Attach the cable ends to each connector box and link cables with cable extenders.**

Plug the LocalTalk cables into the sockets on the LocalTalk connector boxes. (See Figure 3-3.) A cable may go into either socket.

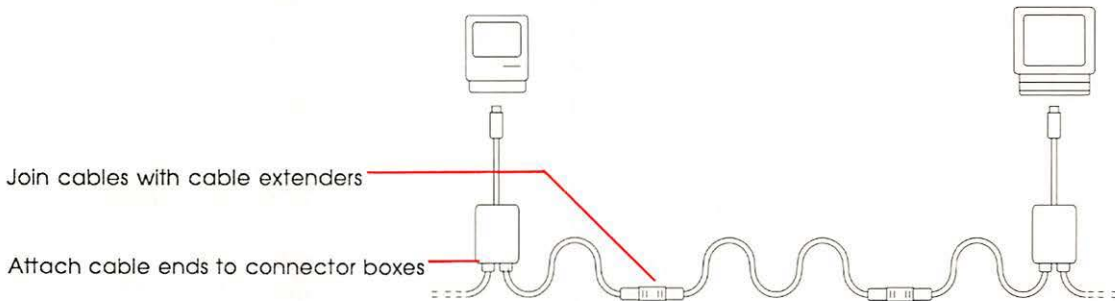

Figure 3-3
Plugging cables into connector boxes

- ❖ *Locking connectors:* To ensure uninterrupted communication over the network, LocalTalk cables are equipped with special locking connectors. Because of this locking design, you can't unplug LocalTalk cables by pulling on the cable. You must unplug them by pulling on the plug.

- **Turn off all the devices to be attached to the network.**
- **Attach the connector box cables to each device.**

The 9-pin plug has thumbscrews; to avoid radio and television interference, tighten them until the connection is firm (but do not overtighten).

If you are attaching the connector box cable to a computer, be sure to plug it into the printer port. (See Figures 3-4 and 3-5.)

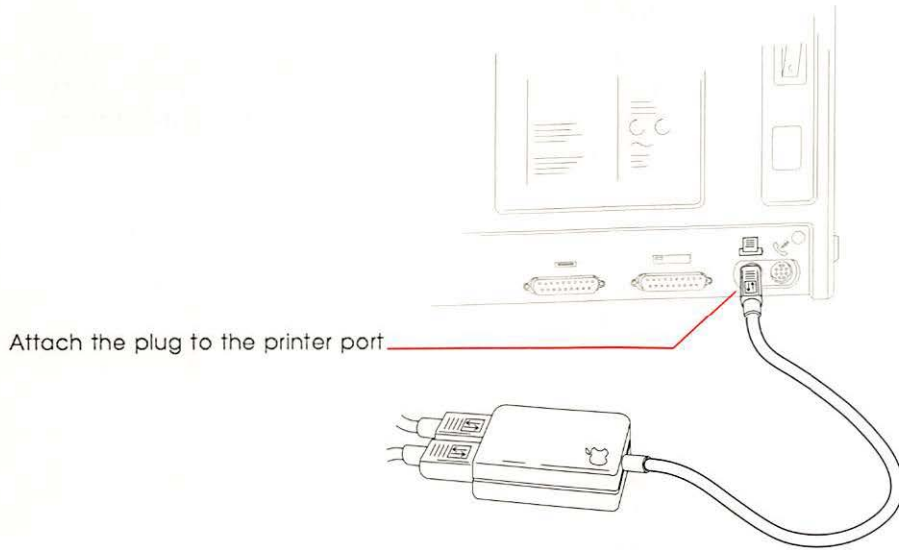

Figure 3-4
Connecting to a Macintosh Plus

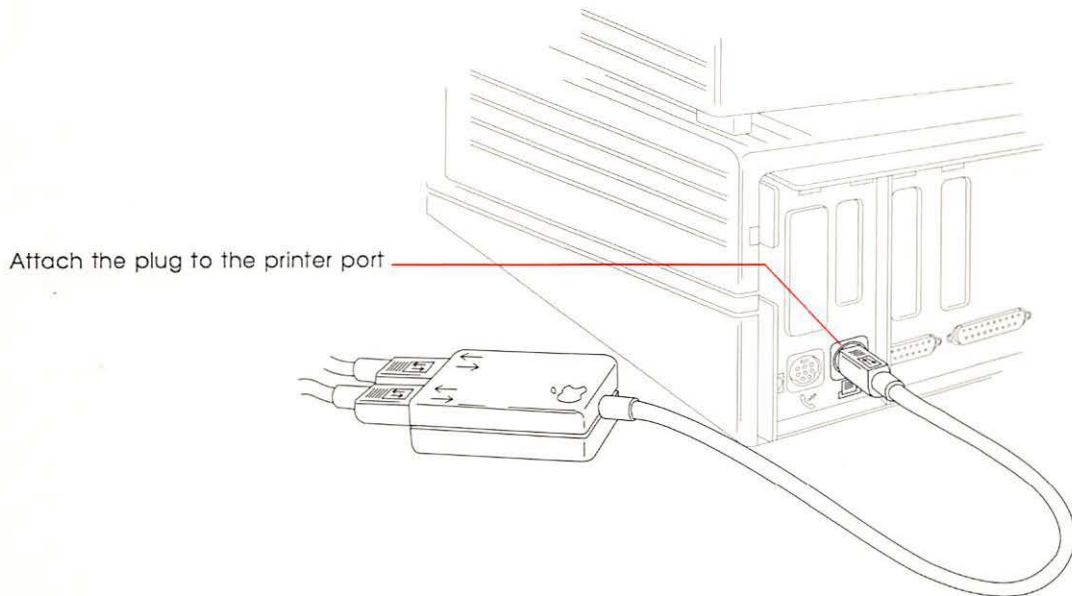

Figure 3-5
Connecting to an Apple IIes

■ **Turn on each device.**

Your network is now installed and ready to use. (See Figure 3-6.) For instructions on using the network, refer to the owner's manual for the specific software package or device you've purchased for use over the network.

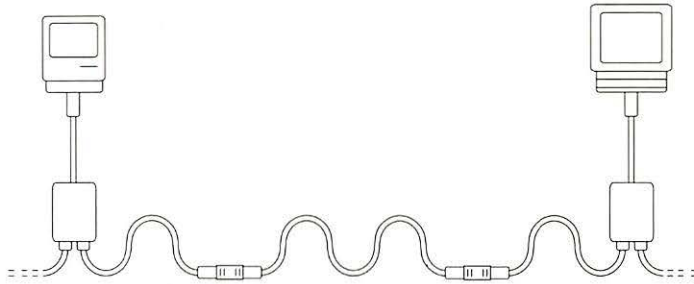
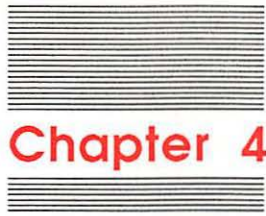

Figure 3-6
An installed network



Chapter 4

Altering an Existing Network

After you've set up your network, there may come a time when you need to change it—by adding, moving, or removing connector boxes and devices. These changes may momentarily disrupt the network. (Whenever you unplug a cable from a connector box within the network, you split one network into two and leave a dangling cable on one of them.) If others are using the network while it's being altered, they will encounter problems. This disruption is an unavoidable consequence of altering the network, so you should warn others *before* you alter the network, and try to work quickly. Following the instructions in this chapter will minimize the amount of time the network is disrupted.

- ❖ *How big is too big?* Before you add new devices to a network, check to make sure you will not exceed the maximum number of connector boxes (32) or the maximum network cable length (300 meters, or about 1000 feet).

Before you attach new devices, be sure to switch off any devices you are adding to or removing from the network. (You don't need to turn off devices that are already attached if they will remain on the network.)

Adding a device to the end of a network

Adding an additional connector box to either end of a network is the easiest way to add new devices and does not disrupt the network.

To add a new device to the end, you'll need a connector box and a cable of the appropriate length. (The following steps are illustrated in Figure 4-1.)

1. Attach the cable to the new connector box.
2. Attach the other end of the cable to the last connector box on the existing network.
3. Switch off the device you want to add to the network and attach the LocalTalk connector box cable to the device. Turn the device on, and it will be connected to the existing network.

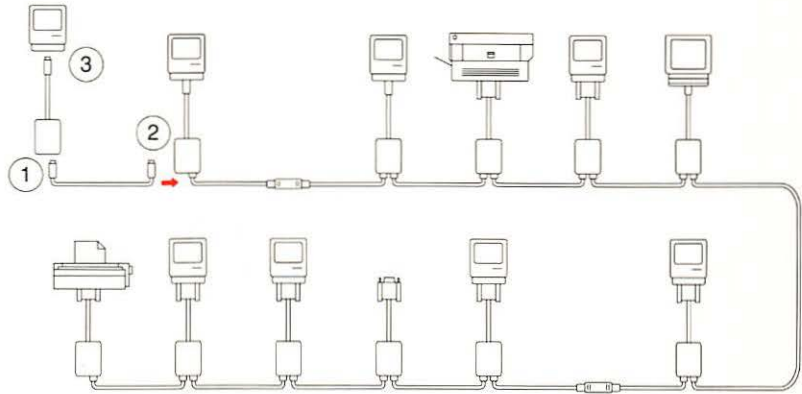

Figure 4-1
Adding a device to the end of a network

Adding a device between two connector boxes

Adding another connector box between connector boxes on an existing network requires that you disrupt the network momentarily. Work quickly to minimize disruption. The following instructions describe two ways to add a device between connector boxes. The first set of instructions assumes that you are simply adding a new connector box. The second set assumes that you are adding a connector box and a cable extender.

With a new connector box and one cable

Steps 1-3 are illustrated in Figure 4-2, steps 4-6 in Figure 4-3.

1. Starting at the new device, attach one end of the new cable to the new connector box.
2. Place the loose end of the new cable next to one of the connector boxes on the network.
3. Unplug a cable from the connector box on the network. (LocalTalk cables are designed to lock in place. You can't disconnect them by pulling on the cable. You must pull on the plug.)

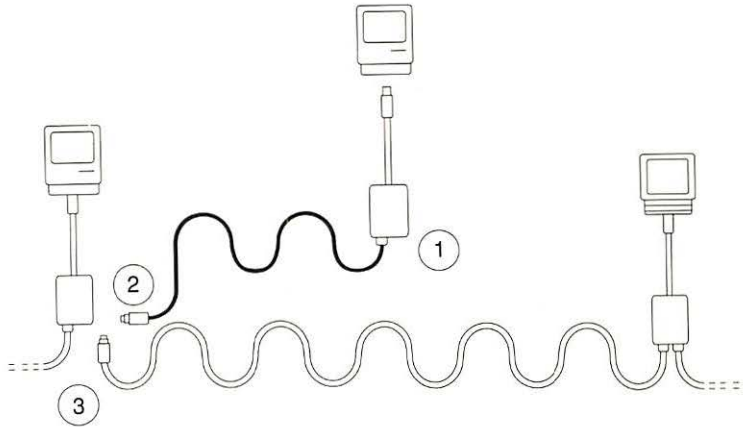

Figure 4-2
Plugging the new cable into the connector boxes

4. Plug the new cable into the connector box on the network.
5. Attach the end of the cable you unplugged from the network to the new connector box.
6. Make sure the new device is switched off; then attach the connector box cable to the device.

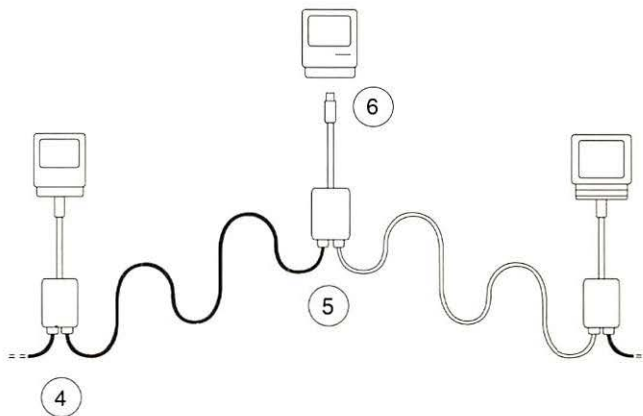

Figure 4-3
Attaching the new connector box to the network and to the new device

With a new connector box, two cables, and a cable extender

This procedure is a bit easier. Steps 1-3 are illustrated in Figure 4-4, steps 4-7 in Figure 4-5.

1. Attach the two cables to the new connector box.
2. Place the cable extender and the unattached ends of both cables next to one of the connector boxes on the network.
3. Unplug a cable from the connector box on the network.
(LocalTalk cables are designed to lock in place. You can't disconnect them by pulling on the cable. You must pull on the plug.)

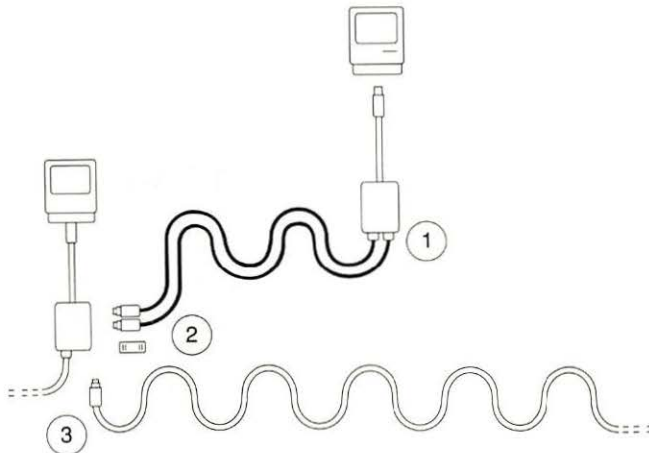

Figure 4-4
Attaching the new cables to the new connector box

4. Plug one of the new cables into the connector box on the network.
5. Attach the cable extender to the cable you unplugged from the network.
6. Plug the other unattached cable into the cable extender.
7. Make sure the new device is switched off; then attach the connector box cable to the device.

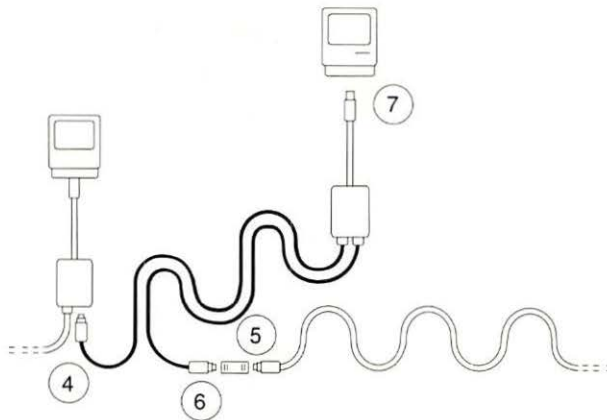

Figure 4-5
Attaching the network cables to the cable extender

Removing a device from a network

The easiest way to remove a device from a network is to switch it off and unplug the connector box cable from the device. (See Figure 4-6.) This method is useful if you just want to take your computer home overnight, for example. You won't disrupt the network, and it's fine to leave the connector box on the network indefinitely without a device attached. If you must remove the connector box from the network, replace it with a cable extender as explained in the following section.

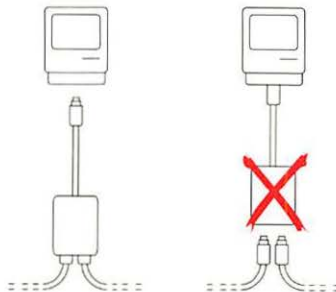

Figure 4-6
Disconnecting the device from the connector box

- ❖ *Startup disks and AppleTalk:* Any time you use a startup disk that doesn't have AppleTalk software installed, you are not part of the network and don't need to disconnect your computer from the network. However, you may need to configure the startup disk to use accessories such as an ImageWriter II printer from the modem port.

You can remove a connector box from the network *permanently* by replacing it with a cable extender. Steps 1-3 are illustrated in Figure 4-7.

1. Turn off the device if it's not already off.
2. Unplug the connector box cable from the device.
3. Unplug the cables from the connector box. (LocalTalk cables are designed to lock in place. You can't disconnect them by pulling on the cable. You must pull on the plug.)

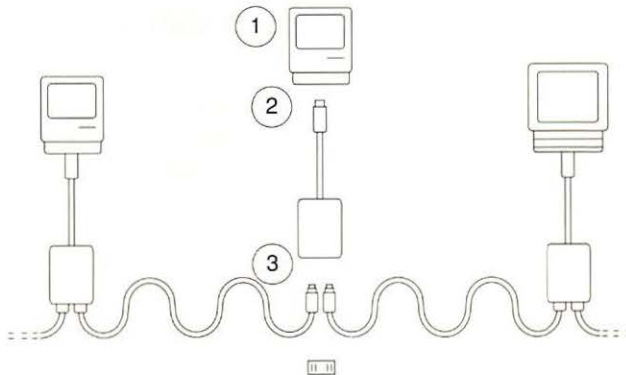

Figure 4-7
Unplugging the connector box

4. Plug each cable into the cable extender. (See Figure 4-8.)

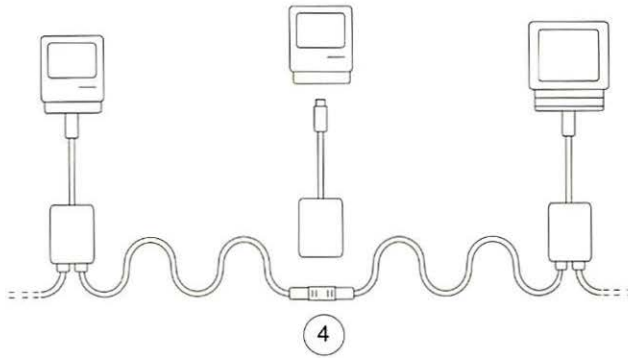
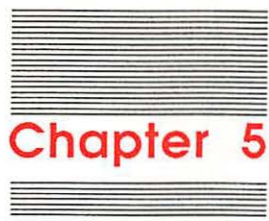

Figure 4-8
Attaching the network cables to the cable extender

Moving a device

To move a device from one place to another on the network, you'll need to remove the connector box to which the device is attached and then add that connector box someplace else on the network. Refer to "Removing a Device From a Network" and "Adding a Device Between Two Connector Boxes," both in this chapter.



Chapter 5

Troubleshooting

Using LocalTalk cables and connectors is fairly simple, so not much can go wrong with the individual components. Most of the problems you'll encounter will be easy to resolve: The LocalTalk plug was in the wrong port, the LaserWriter wasn't warmed up when you tried to print a document, the ImageWriter II was not properly configured, or one of the network rules was broken.

Problems are most likely to occur after you've changed the network in some way. Check to be sure that your recent alterations to the network were made correctly. If that doesn't isolate the problem, repeat the procedure that caused the problem, using different pieces of equipment. If you can't print from your Macintosh, for example, take the same disk to another Macintosh on the same network. If you can print from that computer, the problem is either with your Macintosh or with the network components between your Macintosh and the one where printing succeeded. You can try switching cables and connector boxes to isolate a faulty component.

Here's a checklist to consult whenever you're having problems with the network. If the problem is still unresolved, the trouble may be with a particular device or with the application program you're using. The owner's manual that came with the device or program may be helpful.

■ **Is the LocalTalk connector box cable attached to the correct port?**

The connector box cable should be attached to the printer port. If you need to switch ports, be sure to turn off the device first.

■ **Are the devices you're trying to use attached to the network? Are the devices switched on and ready?**

Someone may have inadvertently disconnected a device. Or the problem may relate to a particular device. Perhaps you did not give a LaserWriter adequate warmup time (about two minutes), or perhaps someone left an ImageWriter II unselected (the green Select light must be on before you can print). See your printer manual for more information.

■ **Are the devices you're trying to use on the same network?**

You may have more than one network in your area, or someone may have split the network by disconnecting a cable from a connector box. Follow the LocalTalk cables from your computer to the device you're trying to use to make sure the devices are on the same network.

■ **Check and tighten all LocalTalk connections.**

Check the cables at each device, connector box, and cable extender.

■ **Check for dangling cables. (See Figure 5-1.)**

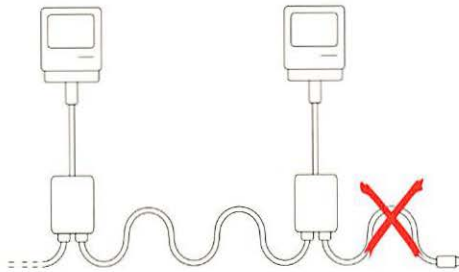

Figure 5-1

The network should end with a connector box

Make sure each end of every cable in the network is attached to a LocalTalk connector box or cable extender. If you find a loose cable, determine whether the connector box to which it is attached is the end of the network. If it is, simply disconnect the cable. Or find the connector box it should be attached to and plug it in (but check to make sure you're not forming a network circle). Remember, a connector box need not be connected to a device; it's OK if the connector box cable (the cable permanently attached to the connector box) isn't attached to anything.

■ **Check for a circular network.**

Follow the network. If it makes a complete circle (you can't find two ends), remove one of the cables from between two connector boxes.

- **Switch each device connected to the network off and back on.**

This reassigns each device's AppleTalk identification number and may sometimes clear up the problem. Try this procedure if only one or two devices are having problems on the network.



Appendix



LocalTalk Information

This appendix provides ordering information, information for independent developers, and a list of specifications for LocalTalk.

LocalTalk ordering information

This list will help you decide what parts to buy for the equipment you have. It also helps to know the part numbers when you order parts.

Network device	Kit	Part number
Macintosh Plus Apple IIGS ImageWriter II with LocalTalk option Macintosh SE Macintosh II	LocalTalk Locking Connector Kit—Din-8	M2068
Macintosh 512K Macintosh 512K enhanced Macintosh 128K	LocalTalk Locking Connector Kit—DB-9	M2065
General purpose	LocalTalk Locking Cable Kit—10-Meter	M2066
General purpose	LocalTalk Locking Cable Kit—25-Meter	M2069
General purpose	LocalTalk Custom Wiring Kit	M2070

Developers' information

Many independent developers are working on AppleTalk products. If you'd like to become an AppleTalk application or hardware developer, ask your authorized Apple dealer about technical documentation. Or write to

AppleTalk Developers' Program
Apple Computer, Inc.
20525 Mariani Avenue
Cupertino, CA 95014
(408) 996-1010

LocalTalk specifications

Topology:	Serial bus, transformer isolated
Wiring:	Shielded twisted pair
Signaling standard:	EIA modified RS-422, balanced voltage
Signaling speed:	230,400 bits per second
Signal encoding:	FM0 (bi-phase space)
Frame format:	SDLC (Synchronous Data Link Control)
Maximum length:	300 meters (984 feet)
Maximum number of connections:	32
Node identification:	Self-configuring, no user action required
RFI and noise immunity:	No RFI (passive taps); common mode noise immunity greater than 500 volts

Cable specifications

Conductors:	22 AWG stranded, 17 ohms per 300 meters
Shield:	85 percent coverage braid
Impedance:	78 ohms nominal
Capacitance:	68 picofarads per meter nominal
Rise time:	175 ns maximum, 0 to 50 percent at 300 meters
Diameter:	4.7 mm (0.183 inches) maximum



Glossary



AppleTalk: A network system consisting of three components: the cable system (LocalTalk, for example), the network-supporting software built into your Macintosh or Apple IIGS computer, and the services that you use over the network (an AppleShare file server and a shared LaserWriter printer, for example).

bus: A line of cable with a beginning and an end, with connection points leading to equipment on the network.



cable: Insulated wire that carries information between computers and peripheral devices in a network. Apple sells cables of standard lengths with plugs attached, as well as bulk cable for custom lengths.

cable extender: A small plastic adapter with a LocalTalk socket on each end that allows you to connect two LocalTalk cables.

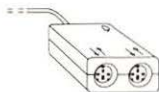

connector box: A small box with a cable attached. LocalTalk cables plug into the box, allowing network signals to flow through the box.

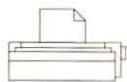

device: Any piece of equipment that can be attached to a network, such as a computer or printer.

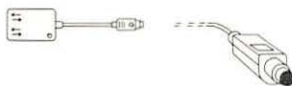

8-pin mini-circular plug: A small, cylindrical connector. The Macintosh Plus, Macintosh SE, Macintosh II, Apple IIGS, and ImageWriter II use this type of plug for LocalTalk and other types of cables.



LocalTalk cables: The physical link between devices in a network. Support for LocalTalk cables and connectors is built into all Macintosh computers and into the Apple IIGS.

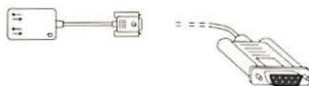

9-pin plug: A standard plug used on a LocalTalk connector box to attach to a Macintosh or other device. The LocalTalk 9-pin plug actually uses only four pins.

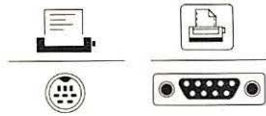

printer port: A socket on the back of a computer, marked with a printer icon. A LocalTalk connector box cable is attached to this port. The Macintosh 128K, Macintosh 512K, and Macintosh 512K enhanced have 9-pin ports. The Macintosh Plus, Macintosh SE, Macintosh II, and Apple IIGS have 8-pin mini-circular ports.

THE APPLE PUBLISHING SYSTEM

This Apple manual was written, edited, and composed on a desktop publishing system using the Apple Macintosh® Plus and Microsoft® Word. Proof and final pages were created on the Apple LaserWriter® Plus. POSTSCRIPT®, the LaserWriter page-description language, was developed by Adobe Systems Incorporated.

Text type is ITC Garamond® (a downloadable font distributed by Adobe Systems). Display type is ITC Avant Garde Gothic®. Bullets are ITC Zapf Dingbats®. Some elements, such as program listings, are set in Apple Courier, a fixed-width font. Line art was created using Adobe Illustrator™.



Apple Computer, Inc.

20525 Mariani Avenue
Cupertino, CA 95014
(408) 996-1010
TLX 171-576

030-0043-A
Printed in U.S.A.