

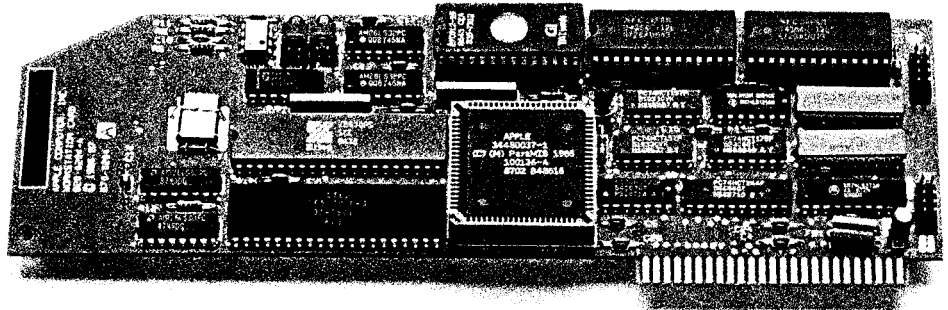

Apple® II Workstation Card User's Guide



LIMITED WARRANTY ON MEDIA AND REPLACEMENT

If you discover physical defects in the manuals distributed with an Apple product or in the media on which a software product is distributed, Apple will replace the media or manuals at no charge to you, provided you return the item to be replaced with proof of purchase to Apple or an authorized Apple dealer during the 90-day period after you purchased the software. In addition, Apple will replace damaged software media and manuals for as long as the software product is included in Apple's Media Exchange Program. While not an upgrade or update method, this program offers additional protection for up to two years or more from the date of your original purchase. See your authorized Apple dealer for program coverage and details. In some countries the replacement period may be different; check with your authorized Apple dealer.

ALL IMPLIED WARRANTIES ON THE MEDIA AND MANUALS, INCLUDING IMPLIED WARRANTIES OF MERCHANTABILITY AND FITNESS FOR A PARTICULAR PURPOSE, ARE LIMITED IN DURATION TO NINETY (90) DAYS FROM THE DATE OF THE ORIGINAL RETAIL PURCHASE OF THIS PRODUCT.

Even though Apple has tested the software and reviewed the documentation, **APPLE MAKES NO WARRANTY OR REPRESENTATION, EITHER EXPRESS OR IMPLIED, WITH RESPECT TO SOFTWARE, ITS QUALITY, PERFORMANCE, MERCHANTABILITY, OR FITNESS FOR A PARTICULAR PURPOSE. AS A RESULT, THIS SOFTWARE IS SOLD "AS IS," AND YOU THE PURCHASER ARE ASSUMING THE ENTIRE RISK AS TO ITS QUALITY AND PERFORMANCE.**

IN NO EVENT WILL APPLE BE LIABLE FOR DIRECT, INDIRECT, SPECIAL, INCIDENTAL, OR CONSEQUENTIAL DAMAGES RESULTING FROM ANY DEFECT IN THE SOFTWARE OR ITS DOCUMENTATION, even if advised of the possibility of such damages. In particular, Apple shall have no liability for any programs or data stored in or used with Apple products, including the costs of recovering such programs or data.

THE WARRANTY AND REMEDIES SET FORTH ABOVE ARE EXCLUSIVE AND IN LIEU OF ALL OTHERS, ORAL OR WRITTEN, EXPRESS OR IMPLIED. No Apple dealer, agent, or employee is authorized to make any modification, extension, or addition to this warranty.

Some states do not allow the exclusion or limitation of implied warranties or liability for incidental or consequential damages, so the above limitation or exclusion may not apply to you. This warranty gives you specific legal rights, and you may also have other rights which vary from state to state.

WARNING

This equipment has been certified to comply with the limits for a Class B computing device, pursuant to Subpart J of Part 15 of FCC rules. See instructions if interference to radio or television reception is suspected.



Apple® II Workstation Card User's Guide

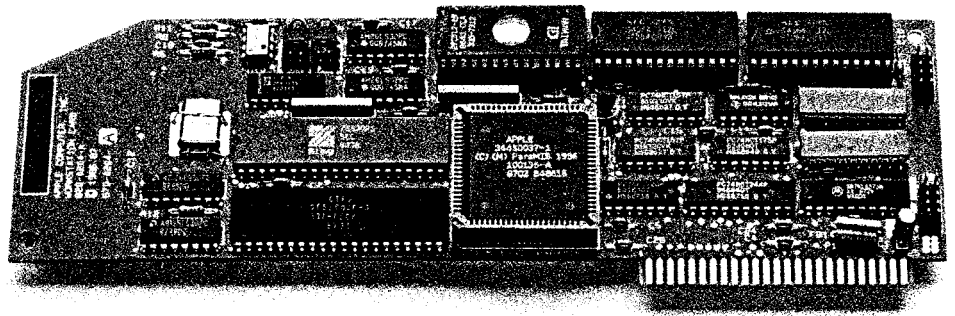

🍏 APPLE COMPUTER, INC.

This manual and the AppleShare IIfx Workstation Software are copyrighted, with all rights reserved to Apple. You are licensed to use the manual and Software on the terms stated in the enclosed Apple License Agreement. You may create startup disks using the AppleShare IIfx Workstation Software for each Apple IIfx on your AppleTalk network system so that the computer can access the file server. You may not sublicense, lend, or otherwise transfer any copy of the AppleShare IIfx Workstation Software unless you transfer all copies of the AppleShare IIfx Workstation Software to the same transferee and the transferee agrees to be subject to the terms of the license and this additional provision.

© Apple Computer, Inc., 1988
20525 Mariani Avenue
Cupertino, CA 95014
(408) 996-1010

Apple, the Apple logo, AppleShare, AppleTalk, Apple IIGS, ImageWriter, LaserWriter, Macintosh, and ProDOS are registered trademarks of Apple Computer, Inc.

Aristotle and LocalTalk are trademarks of Apple Computer, Inc.

IBM and PC-DOS are registered trademarks of International Business Machines Corporation.

ITC Avant Garde Gothic, ITC Garamond, and ITC Zapf Dingbats are registered trademarks of International Typeface Corporation.

Microsoft and MS-DOS are registered trademarks of Microsoft Corporation.

POSTSCRIPT is a registered trademark, and Illustrator is a trademark, of Adobe Systems Incorporated.

The Apple II Workstation Card was codeveloped by ParamIS Acquisitions Corporation.

Simultaneously published in the United States and Canada.



Contents

Figures and tables v

Radio and television interference vi

Preface About the Apple II Workstation Card vii

What you need viii

What's in this guide ix

Chapter 1 Installing Your Card 1

Attaching the back panel adapter box 2

Connecting the card 7

Connecting cables 9

Chapter 2 The AppleShare File Server 11

Learning about AppleShare file servers 12

The file server 12

The workstations 12

The network administrator 13

Organizing information in folders 14

Volumes are like file drawers 14

Folders are like file folders 14

Pathnames tell where to find files 15

Users can create folders 15

Registered users' files are private 16

Logging on to the network 16

Starting up the workstation 17

Starting up by turning on the computer (the most common method) 17

Starting up from the workstation disk (an alternate method) 17

Starting up from a different slot (an alternate method) 18

Logging on to the file server 19

Working with programs on the file server	22
If you start up over the network	22
If you start up from the workstation disk	23
About the prefix-pathname method	23
About logging off	24
Setting access privileges for folders	26
Understanding the privileges	26
Changing the privileges	28

Chapter 3 Using the Programs on Your Workstation Disk 33

What's on the workstation disk	34
Using the workstation disk menu	36
Making a working copy of the disk	37
Using the Namer	38
Using the Chooser	40
Using the System Utilities	43
Using other menu choices	44

Glossary 45

Index 47

Figures and tables

Preface About the Apple II Workstation Card vii

Figure P-1 A network with an AppleShare file server vii

Chapter 1 Installing Your Card 1

Figure 1-1 Attaching the plastic spacer 3
Figure 1-2 Pushing the cables through 4
Figure 1-3 Fitting the box against the opening 5
Figure 1-4 Attaching the metal fastener 6
Figure 1-5 Connecting the cables to the card 7
Figure 1-6 Inserting the card in the slot 8
Figure 1-7 Connecting to a port 9

Chapter 2 The AppleShare File Server 11

Figure 2-1 A network with an AppleShare file server 13
Figure 2-2 Folders on the server 15
Figure 2-3 The server selection screen 19
Figure 2-4 The log-on screen 20
Figure 2-5 The volume selection screen 21
Figure 2-6 The File Server Log Off dialog box 25
Figure 2-7 A folder's information window 27
Figure 2-8 The Access Privileges menu 29
Figure 2-9 Viewing the privileges 30
Table 2-1 Key combinations for assigning access privileges 31

Chapter 3 Using the Programs on Your Workstation Disk 33

Figure 3-1 The workstation disk menu 36
Figure 3-2 Naming a printer 39
Figure 3-3 Choosing a printer 41
Figure 3-4 Ready to quit the Chooser 43

Radio and television interference

The equipment described in this manual generates and uses radio-frequency energy. If it is not installed and used properly—that is, in strict accordance with Apple's instructions—it may cause interference with radio and television reception.

This equipment has been tested and complies with the limits for a Class B computing device in accordance with the specifications in Subpart J, Part 15, of FCC rules. These rules are designed to provide reasonable protection against such interference in a residential installation. However, there is no guarantee that the interference will not occur in a particular installation, especially if a "rabbit-ear" television antenna is used. (A rabbit-ear antenna is the telescoping-rod type usually found on television receivers.)

You can determine whether your computer is causing interference by turning it off. If the interference stops, it was probably caused by the computer or its peripheral devices.

If your computer system does cause interference to radio or television reception, you can try to correct the interference by using one or more of the following measures:

- Turn the television or radio antenna until the interference stops.
- Move the computer to one side or the other of the television or radio.
- Move the computer farther away from the television or radio.
- Plug the computer into an outlet that is on a different circuit than the television or radio. (That is, make certain the computer and the radio or television are on circuits controlled by different circuit breakers or fuses.)
- Consider installing a rooftop television antenna with a coaxial cable lead-in between the antenna and the television.

If necessary, consult your authorized Apple dealer or an experienced radio/television technician for additional suggestions.

You may find helpful the following booklet, prepared by the Federal Communications Commission: "How to Identify and Resolve Radio-TV Interference Problems." This booklet is available from the U.S. Government Printing Office, Washington, DC 20402.

Important

This product was FCC-certified under test conditions that included use of shielded cables and connectors between system components. It is important that you use shielded cables and connectors to reduce the possibility of causing interference to radios, television sets, and other electronic devices. For Apple peripheral devices, you can obtain the proper shielded cable from your authorized Apple dealer. For non-Apple peripheral devices, contact the manufacturer or dealer for assistance.



Preface



About the Apple II Workstation Card

A **workstation** is a computer that you can use to send or receive files over a network.

A **network** is a system of interconnected computers and peripheral devices.

Your Apple® II Workstation Card expands the capabilities of your Apple IIe computer in two ways. First, the card lets you use your computer as a **workstation** on a **network** with an AppleShare® file server. (See Figure P-1.)

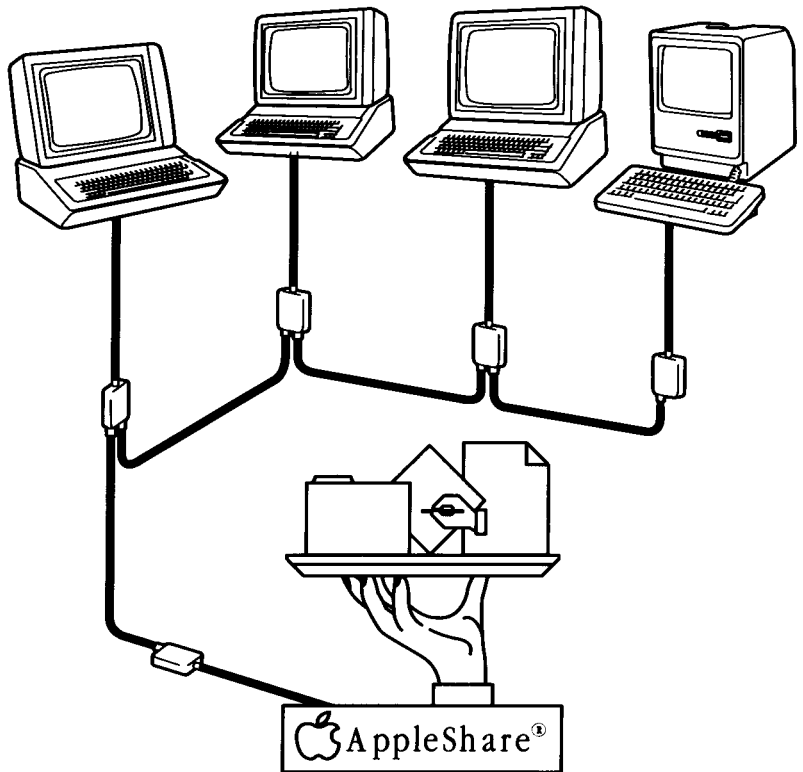

Figure P-1
A network with an AppleShare file server

An **AppleTalk-compatible printer** is one you can use over a LocalTalk network system. The ImageWriter® printer with LocalTalk option and the LaserWriter® printer are examples of AppleTalk-compatible printers.

Second, the card lets you use LocalTalk™ cables to connect your Apple IIe to an **AppleTalk®-compatible printer** and print documents created in most applications based on the ProDOS® operating system.

- ❖ *By the way:* LocalTalk cables were once called *AppleTalk Personal Network cables*. The name was changed to distinguish the AppleTalk network architecture, which operates with a variety of cables, from one type of cable.
- ❖ *Printing with a LaserWriter:* The LaserWriter emulates an ImageWriter when you print from an Apple II. The fonts available are those provided by the application you are using.

What you need

Whether you plan to use your computer as a workstation with an AppleShare file server or just want to be able to print with a network printer from an Apple IIe, you need the following:

- an enhanced Apple IIe computer with at least 128K of random-access memory (RAM)
- an Apple II Workstation Card package, which includes the card, the back panel adapter box and its accessory bag, and the *AppleShare IIe Workstation* disk
- a LocalTalk Locking Connector Kit

What's in this guide

This guide tells you how to install and use the card.

❖ *If you're new to the Apple IIe:* This guide assumes some familiarity with Apple II computers. Before you continue, read your *Apple IIe Owner's Guide* for general information and setup instructions.

Chapter 1 explains how to insert the card in your computer and connect the cables.

Chapter 2 describes the AppleShare file server and explains how to use a workstation on the network. If you will not be using an AppleShare file server, or if you have already read the *AppleShare File Server Administrator's Guide*, you can skip this chapter.

Chapter 3 explains how to use the programs on the *AppleShare IIe Workstation* disk.

The glossary defines terms that may be unfamiliar to you. Terms that appear in **boldface** type in the text also appear in the glossary.

You can read the whole manual, or only those chapters that pertain to your tasks. Most of the instructions you need to follow are written as lists of short, numbered steps in boldface type. Any extra information about a step follows it in one or more separate paragraphs. If you're comfortable with a particular set of instructions, you can speed up your work by reading just the numbered steps.

Aristotle™ menu software is a set of interrelated programs that teachers and students can use on the network. If your network will use the Aristotle software, watch for additional instructions, given in notes labeled ❖ *Aristotle*, in some chapters.

❖ *Note:* An additional manual, the *Apple II System Disk User's Guide*, is included with the Apple II Workstation Card. This manual describes the ProDOS operating system and explains how to use the System Utilities program included on the *AppleShare IIe Workstation* disk.

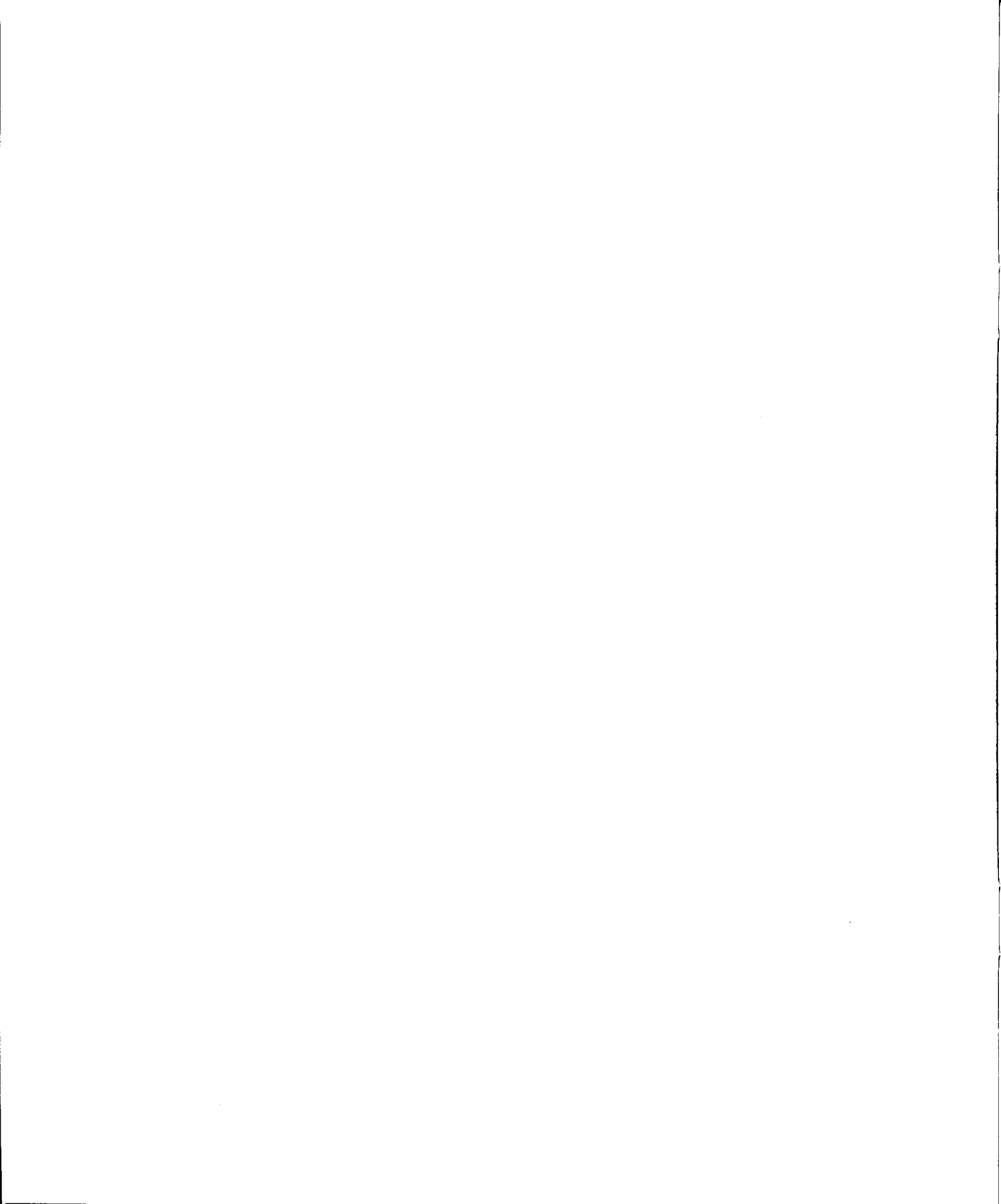



Chapter 1



Installing Your Card

Whether you're creating a workstation for use with an AppleShare® file server or just adding AppleTalk® capability to your Apple® IIe, you follow the same steps to install your card.

Important If you've never installed an interface card in your computer, consult the *Apple IIe Owner's Guide* for specific instructions on removing the cover, putting the card into the slot, and so on.

Attaching the back panel adapter box

Before you insert the card, you attach the adapter box and connect its cables to the card.

Important Make sure the power to your computer is switched off, but leave the power cord plugged into a grounded outlet to ensure that your computer system is safely grounded.

Here's how to attach the adapter box:

1. Remove the computer's cover.

Once the cover is off, be sure to touch the power supply case to discharge any static electricity on your body.

2. Select the slot in which you will install the card.

Slot 7 is the usual slot for a workstation card if you want to start up the workstation from the file server, although you can put the workstation card in any unused slot except slot 3. The slot you choose depends on how you will use the card.

Keep these considerations in mind as you select your slot:

- If you're using the card simply to add AppleTalk capability to an Apple IIe, you can install it in any slot.
- If the workstation has a disk drive and you want to start up from the file server sometimes and from the disk drive sometimes, the slot you use depends on what kind of disk drive you have.

If you have a 3.5-inch disk drive, put the workstation card in a slot with a lower number than the slot that contains the disk controller card. That way, when a disk is in the drive, the workstation will start up from the disk; when the drive is empty, the workstation will start up from the server.

If you have a 5.25-inch disk drive, put the workstation card in a slot with a higher number than the slot that contains the disk controller card. That way, the workstation will start up from the file server unless you temporarily start it up from a different slot. Instructions for doing so are given in “Starting Up From a Different Slot (An Alternate Method)” in Chapter 2.

- If you use applications that expect to print from slot 1 and you intend to use shared printing over the network, put the workstation card in slot 1. (When you use a printer connected to the server, it appears to the application that you’re printing from the slot where the workstation card is installed.)

3. Uncover the appropriate opening.

The back panel of the computer has small, medium, and large openings. Use one of the large openings that’s close to the slot you selected.

4. Snap the plastic spacer onto the adapter box.

Insert the squared-off feet of the spacer into one set of holes in the box. (See Figure 1-1.) Then push the rounded feet into the other set of holes.

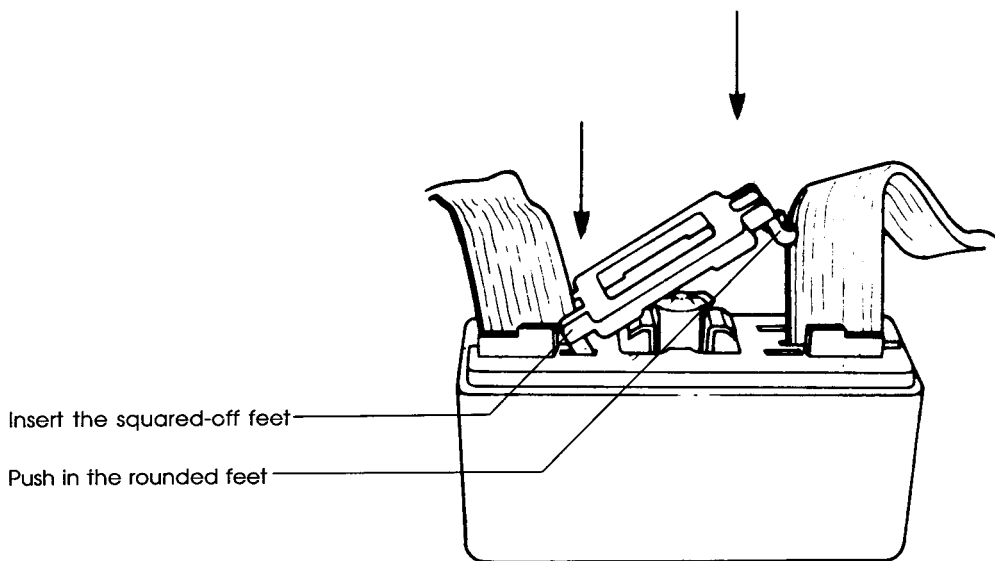

Figure 1-1
Attaching the plastic spacer

5. Push the cables through the opening.

Make sure the colored stripe is at the top of each cable. (See Figure 1-2.)

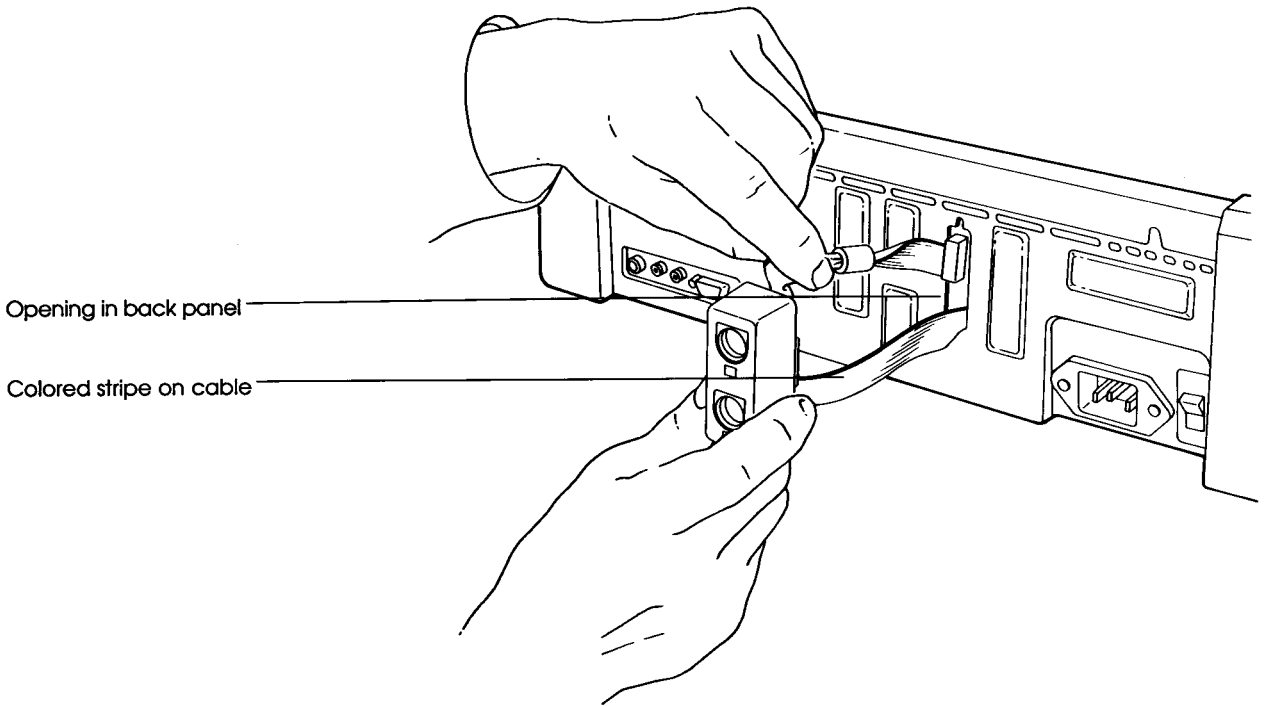

Figure 1-2
Pushing the cables through

6. Position and fasten the box.

Position the box on the outside of the computer's case so that the notches fit on the edges of the opening. (See Figure 1-3.)

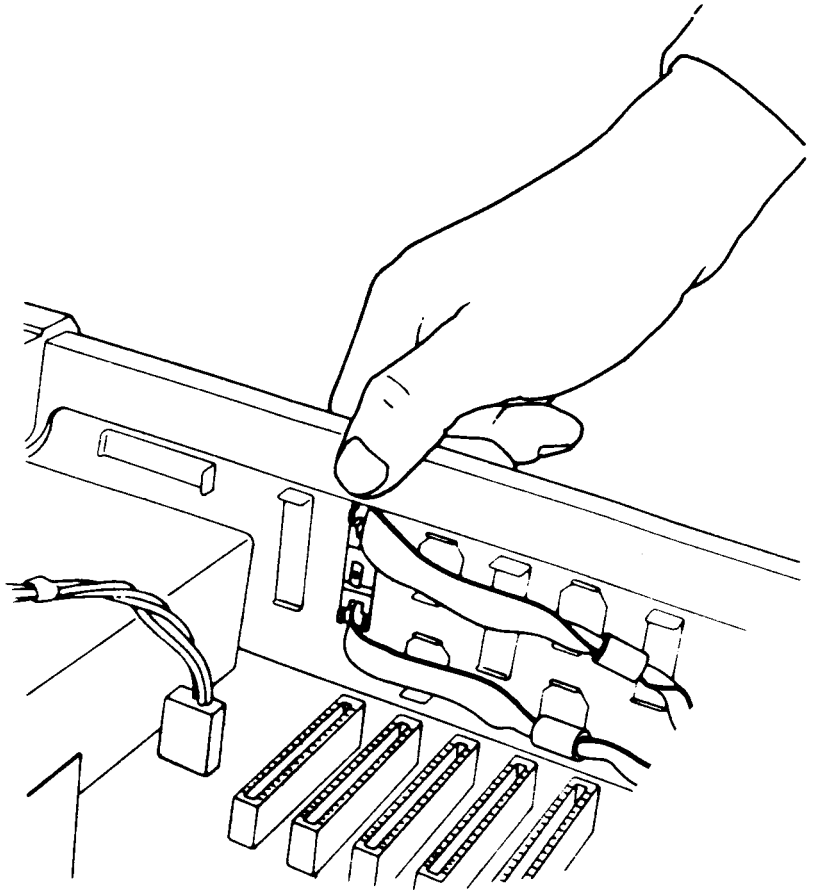

Figure 1-3
Fitting the box against the opening

While holding the box firmly against the case, place the metal fastener over the knob on the inside. (See Figure 1-4.) Lift the fastener slightly so that it can move easily, and then twist it clockwise to secure it.

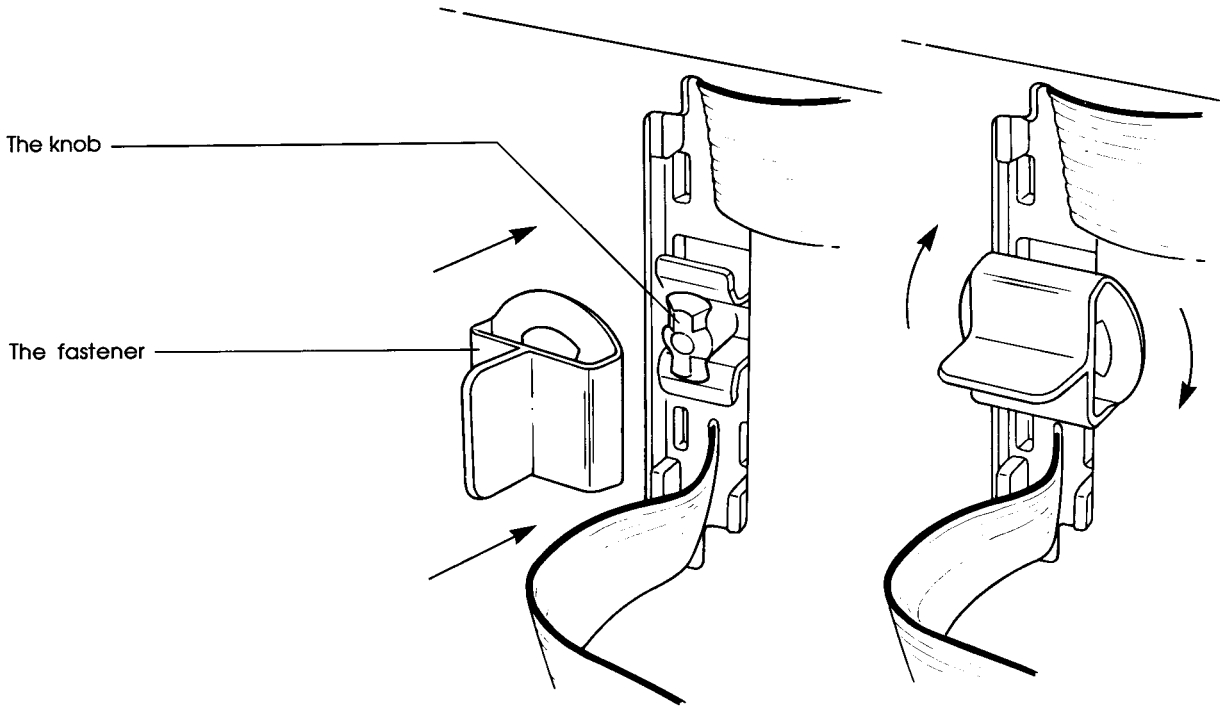

Figure 1-4
Attaching the metal fastener

Connecting the card

Once the adapter box is attached, you can connect its cables to the card and insert the card into the slot.

Here's what to do:

1. Connect the cables to the card.

While keeping the thin colored stripe upward, push the plastic connectors on each cable onto the pin connectors on the card. All 10 pins must go into the corresponding holes in the plastic connector.

Be sure the LocalTalk™ cable from the adapter box (the top cable) goes to the top set of pins on the card, as shown in Figure 1-5.

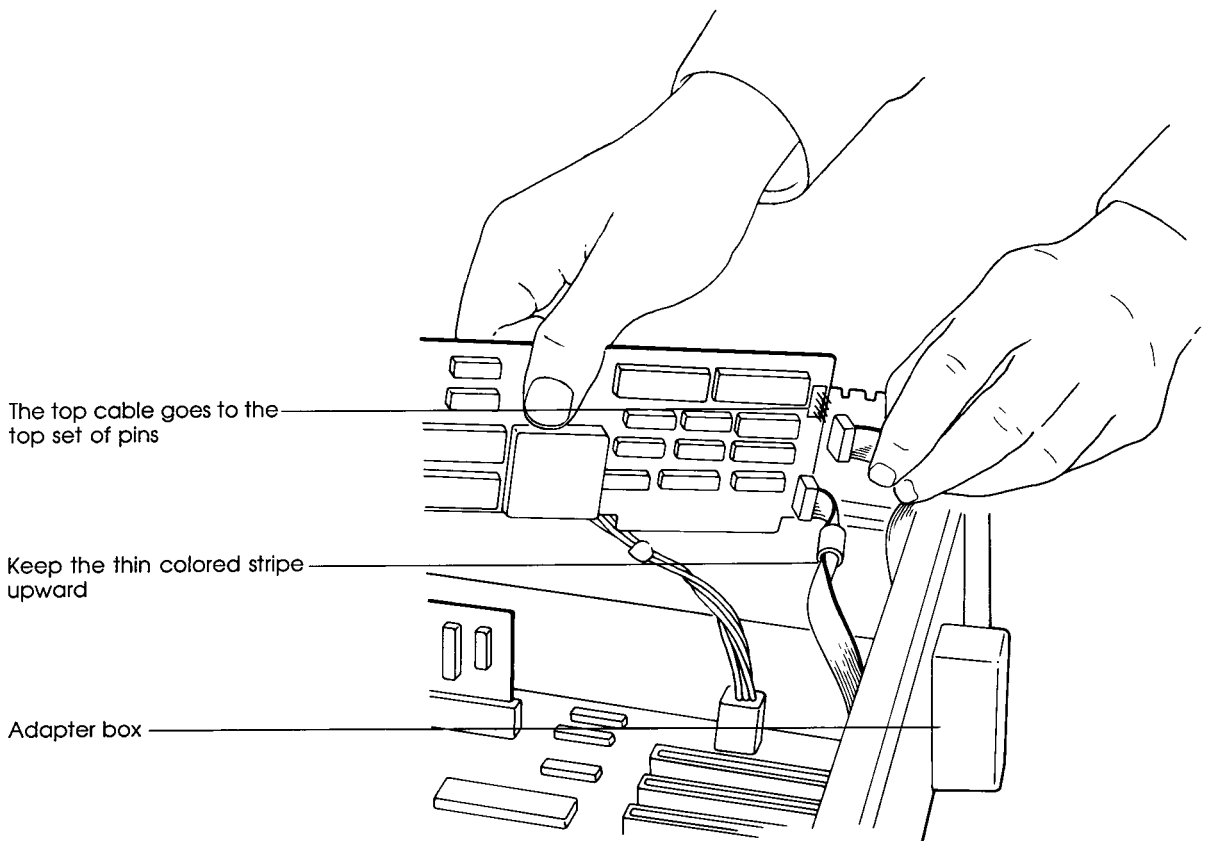

Figure 1-5
Connecting the cables to the card

2. Insert the card.

Push the card down into the slot you've selected, rocking it gently back and forth until it's firmly seated. (See Figure 1-6.) Then replace the computer's cover.

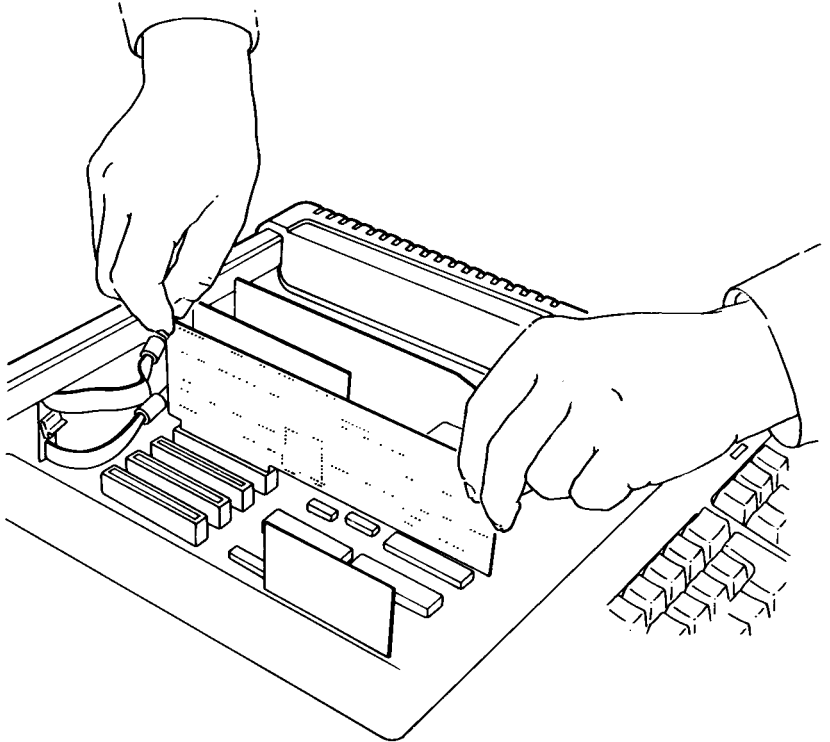

Figure 1-6
Inserting the card in the slot

Connecting cables

Once you have inserted the card, you connect cables to it through the ports on the adapter box. The top port is for the LocalTalk connector box cable; the bottom port is for a printer cable. (See Figure 1-7.)

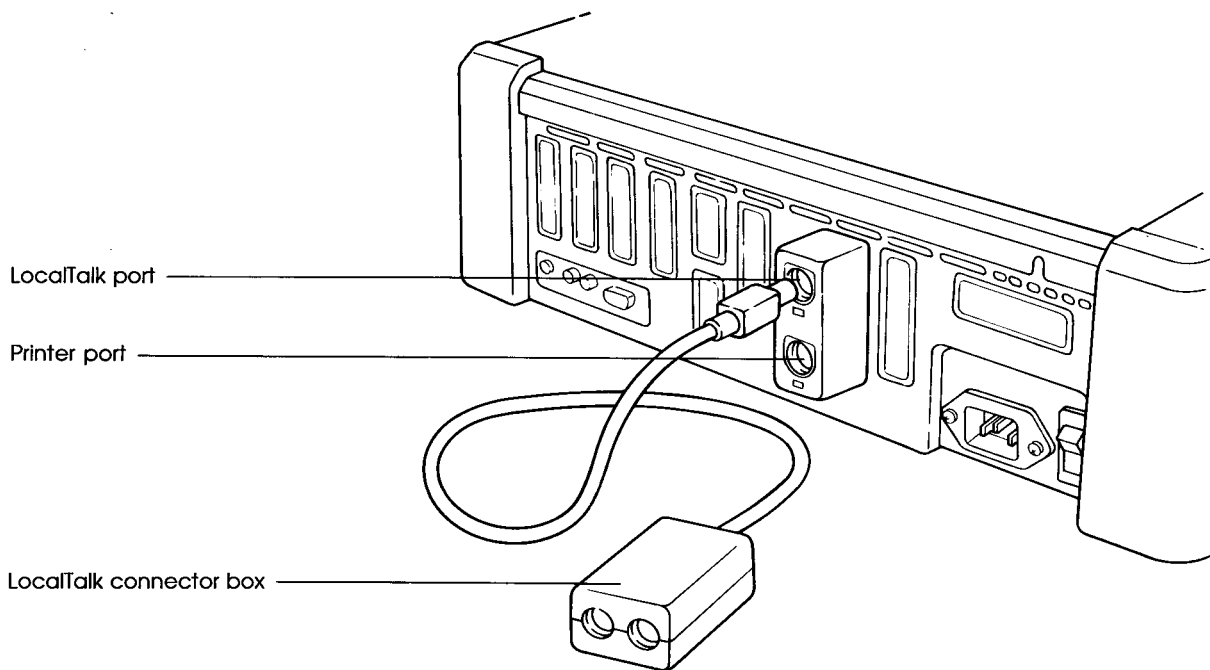

Figure 1-7
Connecting to a port

To connect a printer, you use a printer cable that has a mini-circular connector at each end. You can get this cable, which is called an *Apple System Peripheral-8 Cable*, from your authorized Apple dealer.

❖ *More about the ports:* Although the top port is designated for a LocalTalk cable, *both* ports can function as serial ports, thus giving you great flexibility on one card. For example, with one workstation card installed in your computer, you can connect to a network and also to a local printer. Another way to take advantage of the card is to use it to connect two serial devices to one slot in your computer.

Now you're ready to connect the computer to the LocalTalk cable. If you need to set up a LocalTalk-based network, consult the *LocalTalk Cable System Owner's Guide* for instructions.

The next chapter explains how the AppleShare file server operates and how to use your workstation. If you won't be using an AppleShare file server, turn to Chapter 3.



Chapter 2



The AppleShare File Server

An AppleShare file server is a combination of hardware and software that is used to store and share information and to share devices over a network.

This chapter explains how the file server and workstations work together on the network. If you've already read the *AppleShare File Server Administrator's Guide* and the *AppleShare File Server Administrator's Supplement for Apple II Workstations*, you can skip this chapter.

Learning about AppleShare file servers

When you use AppleShare File Server software, a specially equipped computer, called a **file server**, stores and shares information. You use workstations to send and retrieve information over the network. (See Figure 2-1.) If the workstations have their own disk drives, they can also operate independent of the network.

The file server

An AppleShare file server allows you to use application programs stored on the hard disk and to save files there.

The file server is a specially equipped computer that is dedicated to storing and sharing information; you cannot use it for any other work.

❖ *Note:* In this guide, the terms *file server* and *server* are used interchangeably.

The workstations

A workstation is a computer—an enhanced Apple IIe, an Apple IIGS®, a Macintosh®, or a PC—that is connected to the network. Except for a different way of getting started, you use your workstation the same way you use a **stand-alone computer**.

If your workstation has its own disk drive, you can use it both with the network and as a stand-alone computer.

A **stand-alone computer** has its own disk drive and can operate independent of the network.

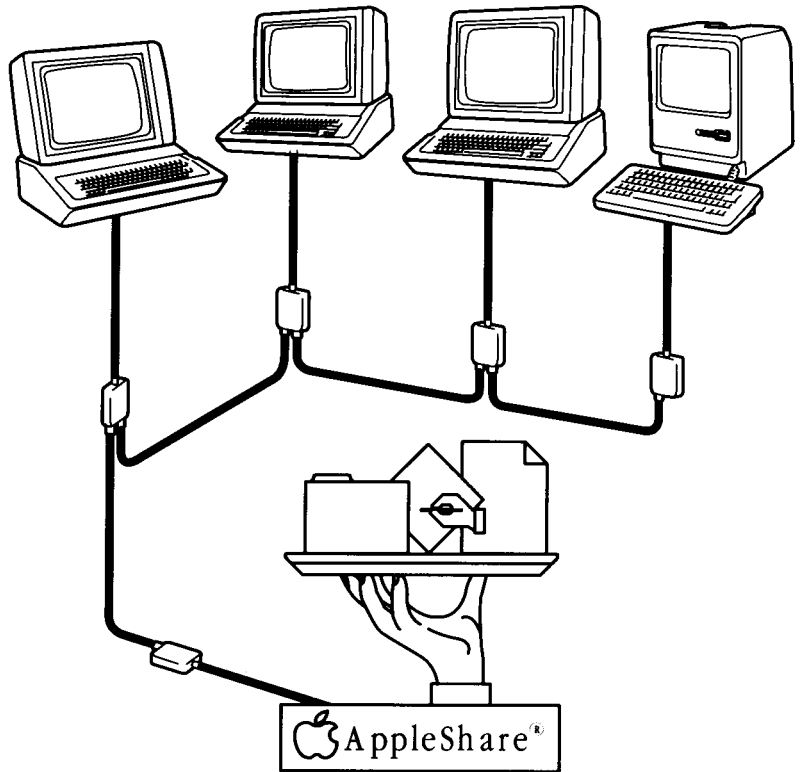

Figure 2-1
A network with an AppleShare file server

The network administrator

The person who sets up the server and keeps everything functioning smoothly is called the *network administrator*.

The administrator will help you get started using the network and should be able to solve any problems you may encounter.

Organizing information in folders

Each hard disk on the server, called a **volume**, can hold a lot of information. To make sure that people who use the server can find what they need without looking through a long list of files, the network administrator usually organizes the information within a volume into folders.

Volumes are like file drawers

The volume is the main organizing unit on the server; it's similar to a drawer in a filing cabinet. Your server has one or more volumes for storing information. Usually, all the files and application programs you need will be in a single volume, but they may be stored in different folders within that volume.

Folders are like file folders

Folders are the secondary organizing unit on the server; they're like folders in a file drawer. (See Figure 2-2.) Folders are equivalent to ProDOS® subdirectories.

Folders are most useful when they hold related files, so your network administrator may have created a folder for each class or group that uses the server. That way, class members can store their work in their class's folder and find it again easily when they need it.

Folders can hold other folders as well as files. If students in an English class write a lot of papers, for example, it would be useful for each student to have his or her own folder within the class's folder.

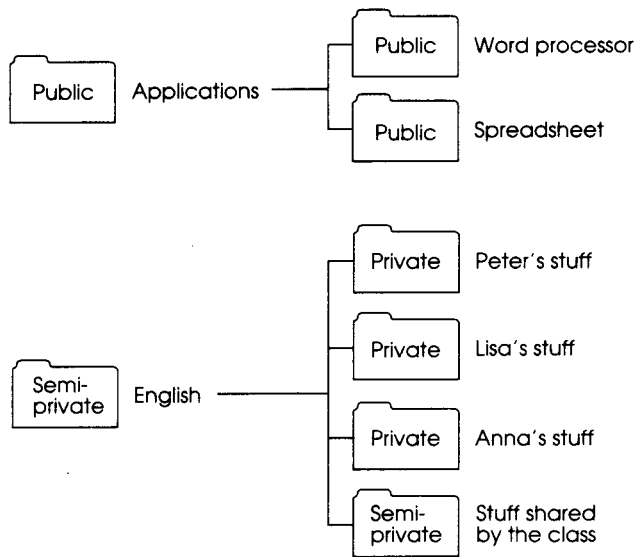

Figure 2-2
Folders on the server

A **pathname** is a sequence of names—the volume name, the folder names, if any, and finally the filename—that tells how to locate and identify a file.

Pathnames tell where to find files

On the server, each file has its own **pathname**. Each part of the pathname begins with a slash. For example, the pathname for a file called POEM in Lisa's folder in the English folder on the APPLE volume might be /APPLE/ENGLISH/LISA/POEM.

When you save a file on the server, you must type its pathname to put it in the correct folder. You type the pathname again in the process of retrieving the file. If you're not sure what pathname to use, ask your network administrator.

Users can create folders

You can create folders on the server for storing your own files. There are two ways to create a folder: from an application and from the Main Menu of the System Utilities.

From an application: Some application programs have a utility that lets you create folders for saving your files. (Many ProDOS applications call these folders *subdirectories*.)

From the Main Menu of the System Utilities: Choose Create a Subdirectory and follow the directions on the screen.

- ❖ *Note:* If you are permitted to use the System Utilities, your network administrator will tell you the pathname and provide you with instructions.

A **registered user** is someone for whom a unique user name, and usually a password, have been assigned.

Registered users' files are private

If you're a **registered user** and you create a folder, everything you store in it is private—no one else can read, copy, or change any of the files. This privacy is useful when you need to keep your work confidential. If you want to share your work with others, however, private folders can get in the way. "Setting Access Privileges for Folders" later in this chapter explains how to control who can see what's in your folders.

- ❖ *Note:* Files saved in private folders are inaccessible to all regular network users. They are, however, accessible to the network administrator. The administrator's maintenance tasks require that he or she be able to move (and consequently to read) any file.

A **guest** is someone who uses the file server without a registered user name or password.

Logging on to the network

The main difference between using a workstation and using a stand-alone computer is in the startup procedure. With a workstation, you must identify yourself to the server (a process called **logging on**) before you can begin to work on programs.

You log on to the server either as a registered user or as a **guest**. (Guests cannot have private folders.)

Starting up the workstation

Before you can log on, you must start up the workstation. In most cases, you simply turn on the computer and it will start up from the server. If your workstation card is in a slot with a lower number than the slot in which your disk controller card is installed, however, you may need to start up from the workstation disk or temporarily start up from a different slot.

This section describes three methods for starting up.

Starting up by turning on the computer (the most common method)

When you turn on the computer, you usually see messages telling you that the workstation is starting up over the network and looking for a server. If you see these messages, go on to the next section, “Logging On to the File Server.” If you don’t see these messages, you must use one of the alternate startup methods described in this section.

Starting up from the workstation disk (an alternate method)

Here’s how to start up from the workstation disk if you have a 3.5-inch disk drive attached to your workstation and the disk controller card is in a slot with a higher number than that of the workstation card:

1. Insert the disk in the drive and turn on the computer.

You see a dialog box asking for your user name.

2. Type your user name.

Type your name on the line and press Return. You then see the workstation disk menu.

❖ *Note:* You need to type your name only once—the first time the workstation disk is used. Thereafter, you see the workstation disk menu as soon as you turn on the computer.

3. Choose File Server Log On.

Press the Down Arrow key to highlight File Server Log On, then press Return.

You should now see the network messages.

❖ *Note:* For information about the other menu selections, see Chapter 3, “Using the Programs on Your Workstation Disk.”

Starting up from a different slot (an alternate method)

If you want to start up over the network but your 5.25-inch disk controller card is in a slot with a higher number than that of the workstation card, you must temporarily start up from another slot.

This procedure is unnecessary for a 3.5-inch disk drive whose controller card is in a slot with a higher number than that of the workstation card. In that case, simply remove any disk from the disk drive, and the computer will skip the corresponding slot.

❖ *About keys and keystrokes:* The Command key, which you may also have seen identified as the Apple key or the Open Apple key, is the key marked with an Apple symbol. On older Apple IIe keyboards that have two keys marked with Apple symbols, the Command key is the one with the outlined Apple symbol.

When you are asked to press two or more keys whose names are joined with hyphens, you should hold down the first key or keys while you press and release the last key.

Here's how to start up from a different slot:

1. Turn on the computer and press Command-Control-Reset. Then press Control-Reset.

You see a bracket prompt on the screen.

❖ *Note:* Occasionally, you may see an asterisk instead of a bracket when you restart the computer. To change the asterisk to a bracket, press Control-C and then Return.

2. Use the PR# command with the correct number, but don't press Return.

Type PR# and then the number of the slot to which the workstation card is connected. (If you don't know the slot number, ask your network administrator.)

3. Press Command-Return.

You should now see the network messages.

Logging on to the file server

Once your workstation is on, you can log on to the file server. This section explains a complete log-on process; your own process may skip some of these steps.

Here's how to log on:

1. Select the server, if necessary.

If you do not see the screen shown in Figure 2-3, go on to step 2.

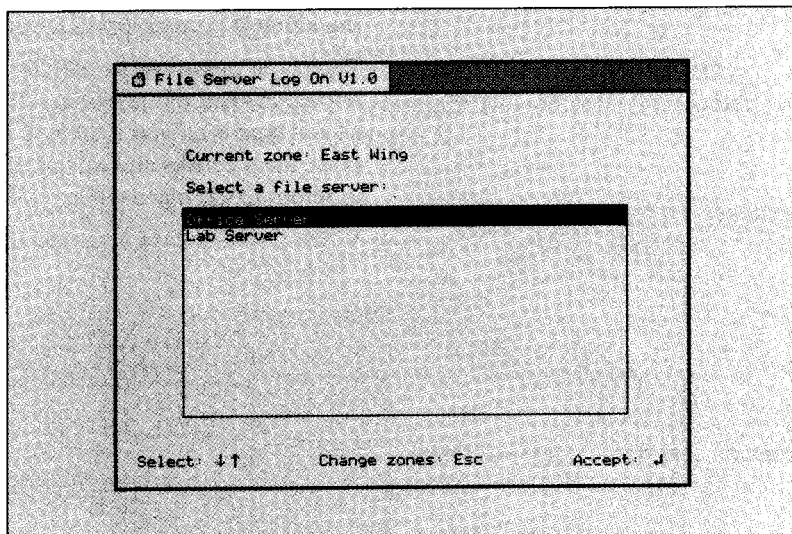

Figure 2-3
The server selection screen

A **zone** consists of one or more networks, identified by a specific name for the users' convenience, that are part of a larger, interconnected network.

You use this screen if more than one server is connected to your network, or if your network is divided into **zones**. Select your server by using the arrow keys to highlight its name, then press Return.

To change to a different zone, press the Esc (Escape) key for a list of available zones. Then highlight the one you want and press Return. If there's more than one server in that zone, you must also select a server.

2. Select the way you want to log on.

You see the top part of the log-on screen shown in Figure 2-4.

Use the arrow keys to highlight the option you want, then press Return.

If you select "Log on as a Guest," skip to step 4.

3. Type your user name and password.

If you have previously used the workstation disk to log on, your user name is already filled in.

If your user name is not filled in, type it *exactly* as it was given to you. (If you make a mistake, use the Delete key and retype.) When the name is correct, press Return.

Type your password *exactly* as it was given to you. (Asterisks will appear instead of the letters so that no one can see your password as you type it.) If you think you made a mistake, use Delete to erase the asterisks and retype the password. Press Tab if you need to return to the place where you typed your user name.

When the password is correct, press Return.

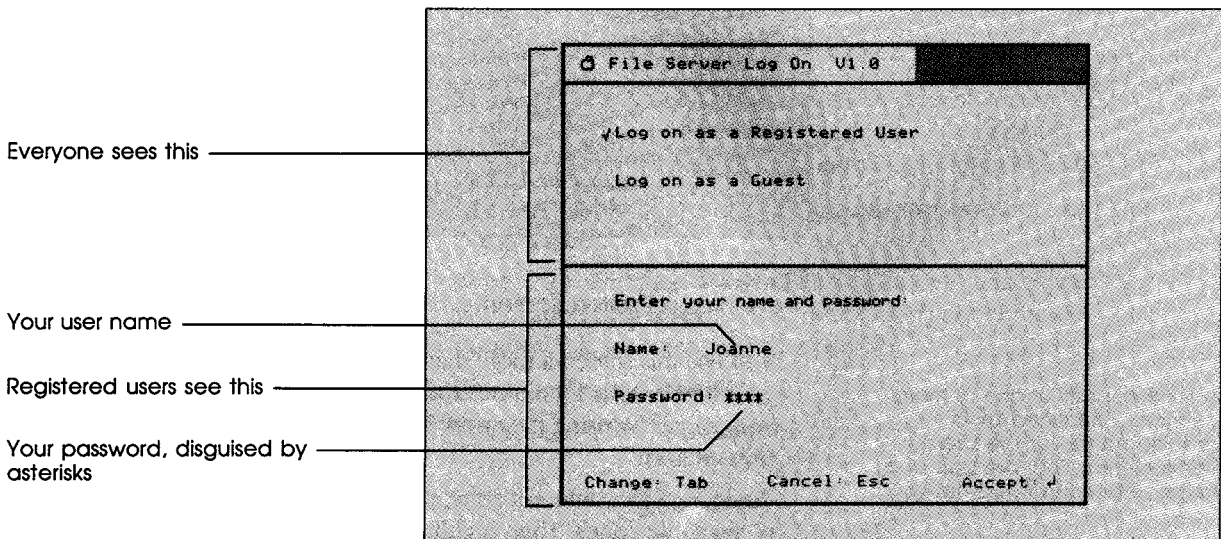

Figure 2-4
The log-on screen

If the information you typed matches the information stored in the server, you're logged on.

- ❖ *If you can't log on:* If the information you typed doesn't match, you'll be asked to type your name and password again. Try it again, being careful to type the words exactly. Be sure to match uppercase and lowercase letters when typing your password. If you still have trouble, check the name and password with your network administrator.

4. Select volumes, if necessary.

If you do not see the screen shown in Figure 2-5, the log-on process is complete. Go on to the next section, "Working With Programs on the File Server."

If there are several volumes, you see the volume selection screen shown in Figure 2-5.

The first volume, marked with a check mark, is automatically selected. Your network administrator will tell you which other volumes, if any, you need to select.

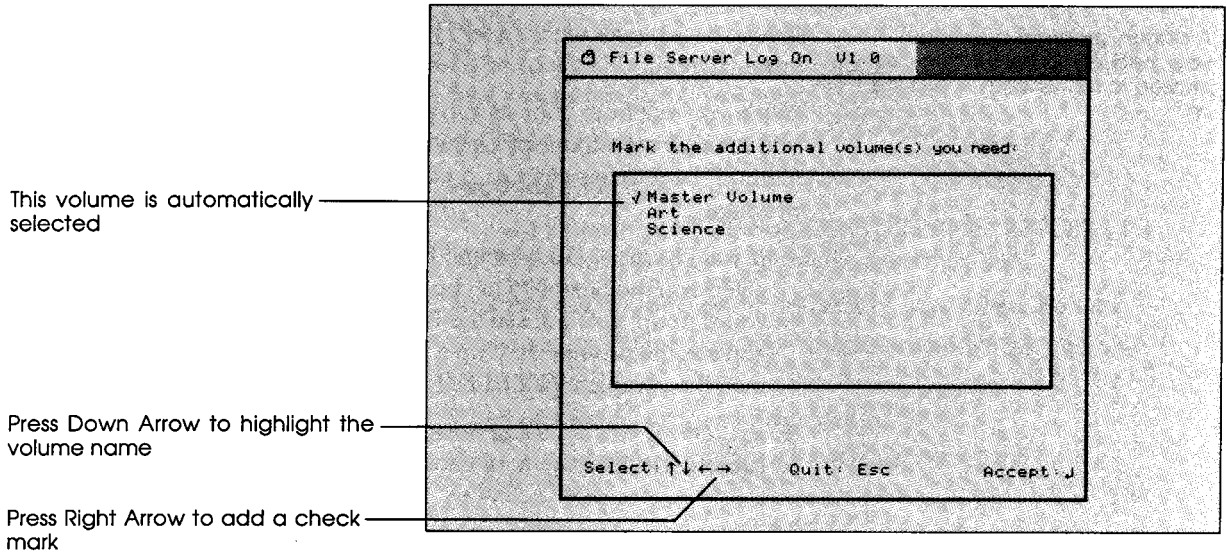

Figure 2-5
The volume selection screen

To place a check mark next to a name, press Down Arrow to highlight the name, then press Right Arrow to mark it. (Pressing Right Arrow again removes the check mark.)

When all the volumes you need are marked with checks, press Return. (If you did not mark any additional volumes, you see a dialog box that offers you an opportunity to go back and do so.)

Working with programs on the file server

What you see right after logging on depends on whether you started up your workstation over the network or by using the workstation disk.

If you start up over the network

If you start up over the network, your **startup program** will run automatically.

When you exit from your startup program, you see a message asking you to enter a prefix or press Return. “About the Prefix-Pathname Method” later in this chapter explains what to do when you see this message.

- ❖ *If you see the BASIC prompt:* If your network administrator has given you the flexibility of choosing your own program when you start up, you will see the BASIC prompt (a bracket). When you see the prompt, start up a program by typing a hyphen and then the complete pathname for the program you want to use.
- ❖ *Aristotle:* If you are using Aristotle™, you will always be presented with a menu of choices. Skip to “About Logging Off.”

A **startup program** is one that your network administrator has chosen to run whenever you log on.

If you start up from the workstation disk

If you start up from the workstation disk, you see its menu again. You can make another selection from it, or you can quit. If you quit, you see a message asking you to enter a prefix or press Return. The next section, "About the Prefix-Pathname Method," explains what to do when you see this message.

About the prefix-pathname method

ProDOS provides an efficient way for you to start up each program you want by prompting you with messages and making suggestions.

In brief, this is what happens: You're asked to type a prefix, and a prefix is suggested. You can accept the suggestion or type a different prefix. Then you're asked for the pathname of the program. Since the prefix is already recorded, you need only type the program's filename.

- ❖ *Note:* To use this method, you must know the complete pathname for every program you will need.

Here's how to start up a program:

1. Read the message.

You see the message ENTER PREFIX (OR PRESS "RETURN" TO ACCEPT), and a prefix is suggested on the next line.

2. Replace the suggestion, if necessary, and press Return.

To replace the suggestion, type a slash to remove it. Then type the new prefix.

When the prefix is correct, press Return.

You see the message ENTER PATHNAME OF NEXT APPLICATION.

3. Type the filename and press Return.

You must type the remainder of the pathname—the part that follows whatever prefix you typed.

Suppose, for example, the pathname for your program is `/MY.VOLUME/MY.FOLDER/PROGRAM.SYSTEM`. If you typed `/MY.VOLUME/MY.FOLDER` for the prefix, you must type `PROGRAM.SYSTEM` when asked for the pathname.

An alternate method is to begin with a slash and type the complete name.

4. Use the program.

If the pathname you typed is correct, the program starts up from the server. When you are finished, quit the program. You see the prefix message again.

If you see an error message such as `FILE/PATH NOT FOUND` or `NOT A TYPE "SYS" FILE`, check your typing to see whether you made a mistake. Then press `Esc` to see the prefix message, and repeat steps 1-3. If you still have trouble, check with your administrator to make sure you're using the correct pathname and that the access privileges are set correctly on all the folders in the pathname.

About logging off

When you finish your session on the server, you **log off** by running the log-off program. Logging off assures that the next person who uses the same workstation will not be able to gain access to your private files.

Here's what to do:

1. Start up the log-off program.

Your network administrator will tell you the pathname for the log-off program. (If you use the workstation disk, choose `File Server Log Off` from the menu.)

You see the dialog box shown in Figure 2-6.

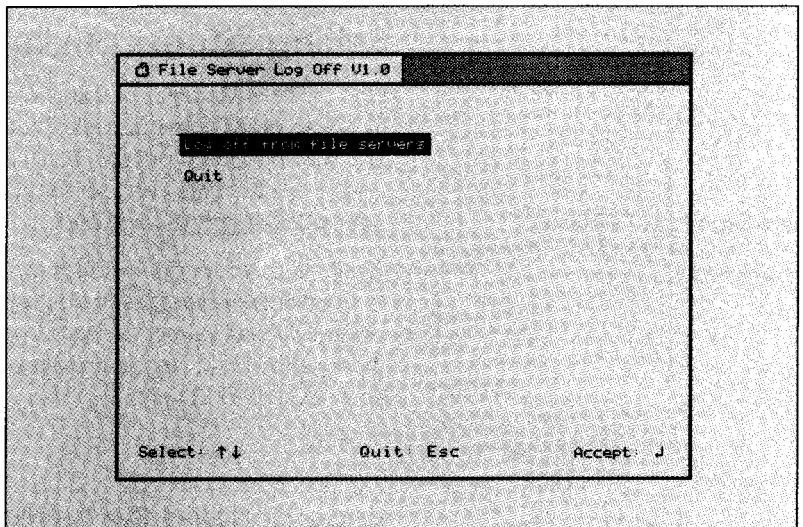

Figure 2-6
The File Server Log Off dialog box

2. Select "Log off from file servers."

Press Return to accept the highlighted option.

You see a message indicating that the log-off process was successful.

❖ *Note:* This is a safe time to turn off the workstation.

3. Press Return.

If you are using the workstation disk, you will see its menu again.

If you used the log-off program from the server, the workstation automatically restarts, ready for the next user.

❖ *Note:* An alternative to logging off is restarting the workstation, or simply turning it off. Although these methods are easier for you, they are not recommended. Both start a waiting period on the network that may delay the next person who wants to log on at your workstation.

Locking a folder prevents anyone from renaming, moving, or deleting it.

Setting access privileges for folders

One of the advantages of using a network is that you can easily share files with other network users. Once you decide which files to share and which to keep private, you use the Access Privileges program to set the appropriate controls for each of your folders. You also use Access Privileges to **lock** folders.

Check with your administrator to see whether you are permitted to use Access Privileges. If you are, ask the administrator for the program's pathname. (Access Privileges is also available on the workstation disk.) If you are not permitted to use Access Privileges, you can skip to Chapter 3.

Understanding the privileges

When you create a folder on a server volume (or move an existing folder to a server volume), you are the folder's owner. If you are logged on to the server as a registered user when you create a new folder (or copy or move an existing folder), the folder is automatically private. Only you can see and change the folder's contents. If you want others to have access to what your folder contains, you must change the folder's access privilege settings.

If you're logged on to the server as a guest when you create a new folder (or copy or move an existing folder), the folder's owner is <Any User>. This means that any user with access to the server can use the information in the folder and can claim the folder as his or her own.

When you set access privileges, you must decide what access you want to give to each of three user categories: Owner, Group, and Everyone.

Owner: The person who created or was assigned ownership of a folder is the owner. The owner is named in the folder's information window. (See Figure 2-7.)

Group: A group is a set of users assigned a group name. The group (if any) is named in the folder's information window.

Everyone: This category includes any user with access to the server, whether logged on as a registered user or as a guest.

Owner's name

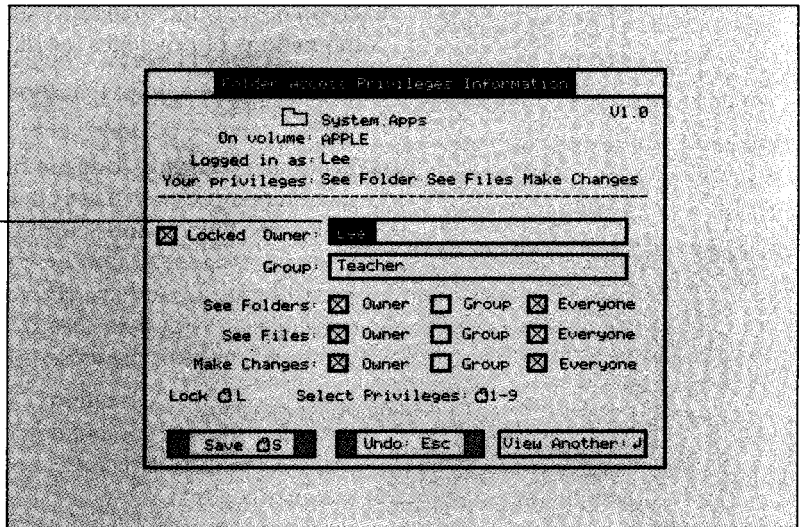

Figure 2-7

A folder's information window

You may assign to each of the three user categories any of three privileges: See Folders, See Files, and Make Changes.

See Folders: This privilege allows people to see the names of any folders within the one for which you're setting access privileges. Whether any of the folders within that folder may then be opened depends on the privileges that have been set for those folders.

See Files: This privilege allows people to see the names of the files in the folder (when they catalog that folder) and to use or copy any of the files. (The copies of files can, of course, be changed.)

Make Changes: This privilege allows people to move, change, or delete files, and even to add new files and folders to the folder.

Each privilege is independent of the others, so you can use different combinations of privileges for different purposes.

Here are some examples that show how to combine privileges on folders:

- Make an electronic “bulletin board.” If a folder contains information or a program that you want people to use but not change, assign See Folders and See Files to Everyone, but keep Make Changes assigned to Owner. If you want only members of a particular group to have access to that information, assign the privileges to Group, instead of Everyone, and make sure the group is named in the folder’s information window.
- Make an electronic “mailbox.” If you want a folder where people can leave files for you but not read what others have left, assign Make Changes to Everyone, but keep See Folders and See Files assigned to Owner.
- ❖ *Note:* When you try to copy a file to or from a folder for which you do not have the appropriate privileges, you may see misleading error messages. Check the folder’s access privileges before assuming that something is wrong with the network.

Changing the privileges

This section explains how to see what privileges are currently assigned for a folder you own and then tells how to change them.

- ❖ *Mouse or keyboard:* The Access Privileges program can be used with either the mouse or the keyboard. Keyboard instructions are given in the text; mouse users can point and click instead of pressing the key combinations.

Here's what to do:

1. Run Access Privileges.

Choose Access Privileges from the workstation disk menu or start it up from the server.

You see the Access Privileges menu (Figure 2-8).

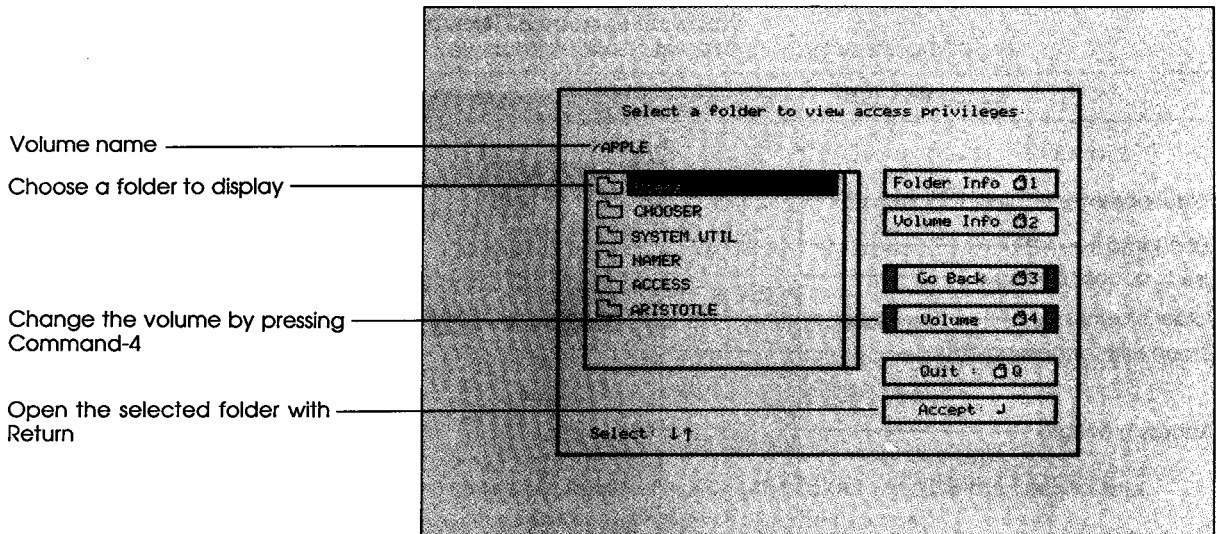

Figure 2-8
The Access Privileges menu

2. Choose a different volume, if necessary.

Examine the folders on the volume to find the one you need. Use the arrow keys, if necessary, to display folders farther down in the list. Change to a different volume, if necessary, by pressing Command-4.

3. Choose the folder and display its access privileges.

Use the arrow keys to highlight the name of the folder you want to change. (See Figure 2-8.) Then press Command-1 to display the folder information. (See Figure 2-9.)

- ❖ *Finding the folder:* If the folder you want is inside another folder, highlight the outer folder and open it by pressing Return. Continue opening folders until you highlight the one you want to change. Then press Command-1.

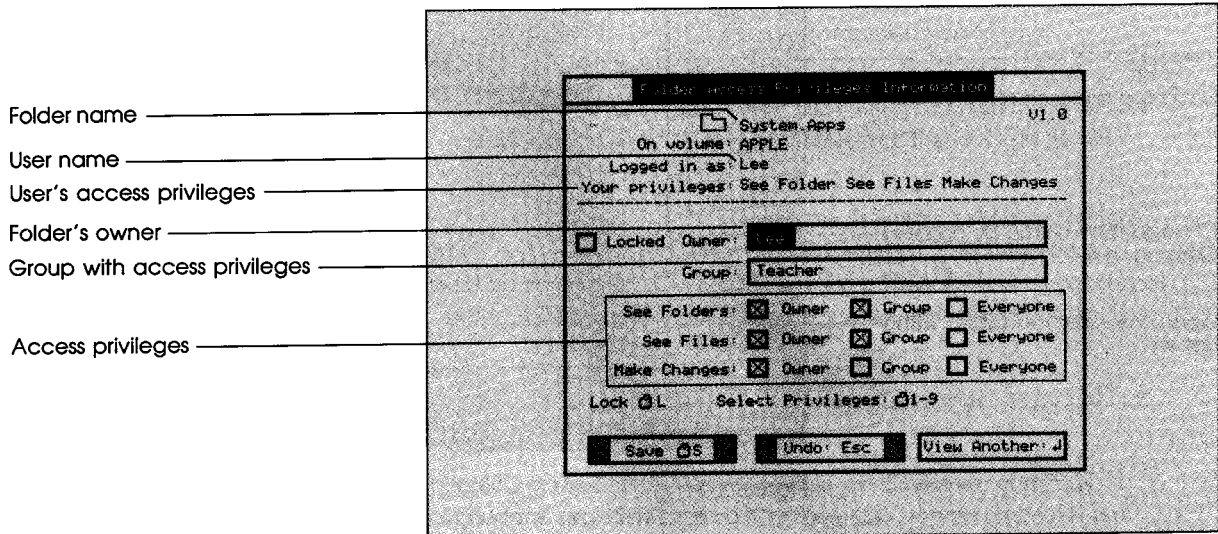

Figure 2-9
Viewing the privileges

4. Assign privileges as needed.

Press the appropriate key combinations (or click the boxes) to change the privileges. (See Table 2-1.)

To assign See Folders to Group, as shown here, press Command-2; to assign See Files to Group, press Command-5. (To remove a privilege, press the same key combination again.)

Table 2-1

Key combinations for assigning access privileges

Privilege	User categories		
See Folders	Owner (⌘-1)	Group (⌘-2)	Everyone (⌘-3)
See Files	Owner (⌘-4)	Group (⌘-5)	Everyone (⌘-6)
Make Changes	Owner (⌘-7)	Group (⌘-8)	Everyone (⌘-9)

5. Correct the group name, if necessary.

Press Tab to highlight the group name, then type the name of the group to which you're assigning privileges.

6. Lock the folder, if necessary.

Press Command-L to lock the folder, or click the Locked box. (To unlock the folder, repeat the process.)

7. Save the changes.

Press Command-S to save the new access privileges, then press Return to view another folder. You can choose another folder and examine its access privileges, go back to another folder if there was one, or quit.

Important If you have assigned privileges to Group or Everyone for a folder that is inside another folder, be sure to assign the See Folders privilege for the outer folder. If you do not, other users may not be able to get to the folder you want them to use.

The owner of a folder has four exclusive rights: the right to lock or unlock the folder, the right to set access privileges for the folder, the right to change the group associated with the folder, and the right to transfer ownership of the folder. Ownership may be transferred to another registered user or to <Any User>. Until you change them, the privileges for all the other folders you created are assigned to Owner, and no one but you can use what's in those folders.

Now you're ready to use the server. If you will be using the Chooser to designate a particular printer, or if you want to learn about the other programs on the workstation disk, you can read about them in the next chapter.



Chapter 3



Using the Programs on Your Workstation Disk

This chapter describes the programs on the *AppleShare IIe Workstation* disk and explains how to use them. Look over this chapter even if you don't have an attached disk drive; some of the programs can be copied onto the server and used over the network.

What's on the workstation disk

The following programs are included on the *AppleShare IIe Workstation* disk:

- The *Printer Namer* (also called the *Namer*) is used to change the name of any network printer, such as a LaserWriter.
Usually, one person on the network is responsible for using the Namer.
- The *Chooser* is used to specify which printer will be used to print a document.
Ask your network administrator whether you should use the Chooser. If you use pathnames to start up programs on the server, ask the network administrator for the appropriate pathname for the Chooser.
- The *System Utilities* are used for organizing and working with files and disks. If you have a disk drive connected to your computer, you can use the System Utilities from the workstation disk.
If you don't have a disk drive, ask your network administrator whether you are permitted to use the copy of the System Utilities that is stored on the server. If you use pathnames to start up programs on the server, ask your network administrator for the appropriate pathname.
- *File Server Log On* is used to log on to a server. You use this program if you have an attached disk drive or if you want to log on to an additional server.
When you use File Server Log On, you follow the log-on procedure described in "Logging On to the File Server" in Chapter 2.

- *File Server Log Off* is used to end a session on the server and is explained in “About Logging Off” in Chapter 2.

If you don't have a disk drive, ask your network administrator whether you are permitted to use the copy of File Server Log Off that is stored on the server. If you use pathnames to start up programs on the server, ask your network administrator for the appropriate pathname.

- The *Access Privileges* program is used to restrict or expand access to your folders and is explained in “Setting Access Privileges for Folders” in Chapter 2. You can use this program only with folders that are stored on the server.

If you don't have a disk drive, ask your network administrator whether you are permitted to use the copy of Access Privileges that is stored on the server. If you use pathnames to start up programs on the server, ask your network administrator for the appropriate pathname.

- *ProDOS BASIC* is used to run AppleSoft BASIC, the version of BASIC built into the Apple IIe.

If you don't have a disk drive, ask your network administrator if you are permitted to use the copy of ProDOS BASIC that is stored on the server. If you use pathnames to start up programs on the server, ask your network administrator for the appropriate pathname.

- *FastCopy* is used to copy a disk quickly between two drives of the same size. (FastCopy cannot be used to copy files between the server and a local drive or between a 5.25-inch drive and a 3.5-inch drive. To do that, use the System Utilities.) Refer to the *Apple II System Disk User's Guide* for more information about FastCopy.

Using the workstation disk menu

When you start up your computer from the workstation disk, you see the menu shown in Figure 3-1.

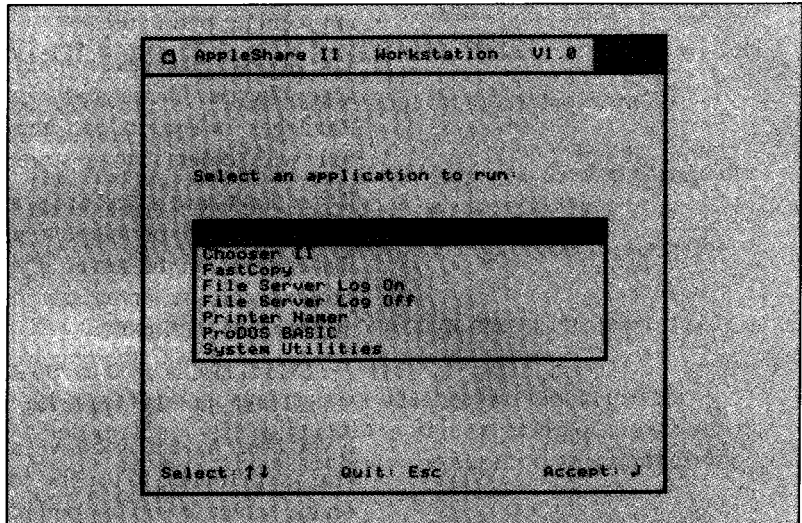

Figure 3-1
The workstation disk menu

To select an item, press Down Arrow to highlight it, then press Return. You see this menu again whenever you quit a program you selected from it.

Important Before you use the workstation disk for your own work, you should make a working copy. Then put the original in a safe place and use the copy.

Making a working copy of the disk

If you're a network user, you can skip this section; your network administrator will have made the copy.

Here's how to make a copy of the disk:

1. Start up the computer from the disk.

Insert the workstation disk in the 3.5-inch disk drive and turn on the computer and monitor.

If you see a message indicating that you are starting up over the network, you need to restart the computer and change the startup slot. See "Starting Up From the Workstation Disk (An Alternate Method)" in Chapter 2 for instructions.

2. Choose FastCopy.

Press Down Arrow to highlight FastCopy. Then press Return.

3. Follow the directions to copy a disk.

Follow the directions on the screen to choose the Copy a Disk option and to indicate the disk type (3.5-inch or 5.25-inch).

❖ *One-drive users:* If you have only one disk drive, you will be instructed to swap disks as many as six times.

When the copying process is complete, you can copy another disk or quit FastCopy and return to the workstation disk menu.

Using the Namer

If you want to name a network printer, you use the Namer. Naming a printer is optional, because network printers name themselves. The names they use are rather plain, however—*LaserWriter1*, *LaserWriter2*, and so on—so you might want to use more imaginative ones.

Important When you name a printer, be sure to tell the new name to everyone who uses the network; other users must run the Chooser again before they can use the renamed printer.

Following are the steps for naming a printer. This program can be used with either the mouse or the keyboard. Keyboard instructions are given in the text; mouse users can point and click instead of pressing the key combinations.

1. Turn on the printer you want to name.

2. Choose Printer Namer from the workstation disk menu.

You see the screen shown in Figure 3-2.

3. Choose the type of printer.

Highlight the name in the device list and press Return. A list of printers of that type appears in the box on the right. (It's usually more convenient to name all printers of one type before you select the next type.)

4. Choose the particular printer.

Press Tab to move to the printer list. Then choose the name of the particular printer you want to rename.

❖ *Note:* You can rename only those printers in your zone.

5. Change the name.

Edit the existing name or type a new one. (See Figure 3-2.) Then press Return.

6. Rename any other printers.

Repeat steps 4 and 5 to rename any other printers of that type. Then, if appropriate, repeat step 3 to choose another type of printer. Follow the same steps to rename printers of that type.

7. Quit.

When you have named all the printers, press Command-Q.

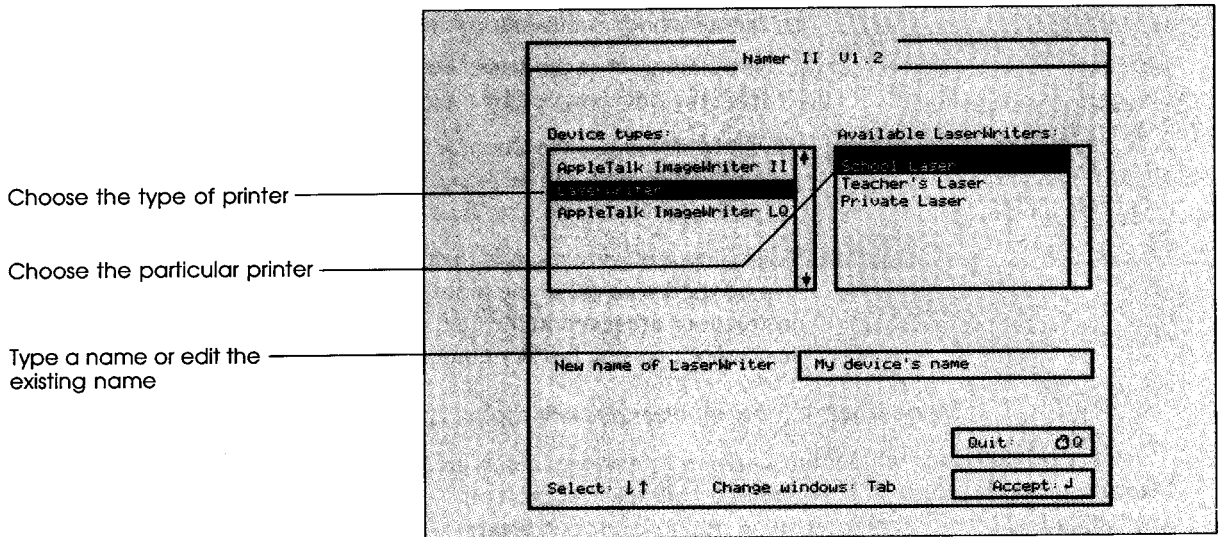

Figure 3-2
Naming a printer

Using the Chooser

You use the Chooser to specify which printer you will use to print a document.

If you use the Chooser from the workstation disk, the name of the printer you choose can be stored on the disk. As a result, you will not need to use the Chooser again unless

- you want to change printers
- you restart the workstation from another disk
- someone renames the printer you selected
- the network administrator removes the printer you selected
- you start up from the server and want to use a different printer from the one assigned by the network administrator

Similarly, if you use the Chooser from the server, the name of the printer you choose can be stored on the server, and in most cases you will not need to use the Chooser again.

Following are instructions for using the Chooser. This program can be used with either the mouse or the keyboard. Keyboard instructions are given in the text; mouse users can point and click instead of pressing the key combinations.

1. Start up the Chooser.

You see a screen similar to the one in Figure 3-3.

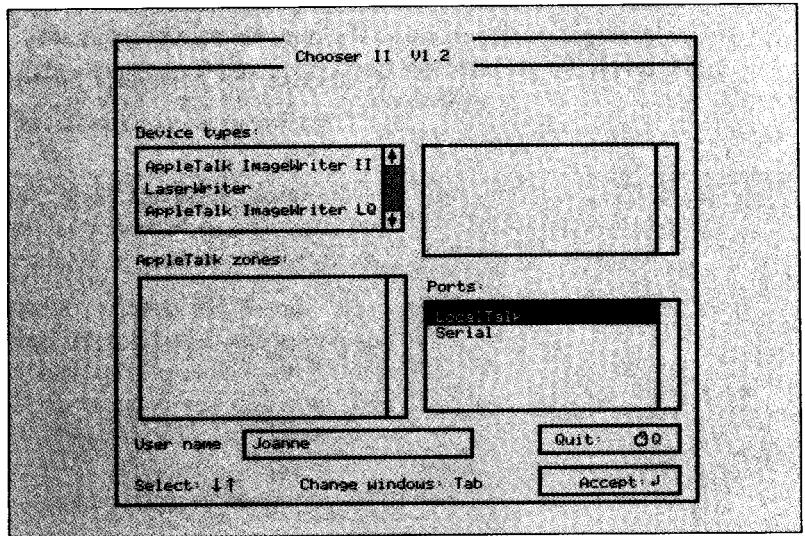

Figure 3-3
Choosing a printer

2. Select the appropriate port, if necessary.

If you're choosing a network printer, the LocalTalk option in the Ports box should be highlighted. If you're choosing a local printer, the Serial option in the Ports box should be highlighted.

If the port you need isn't highlighted, press Tab to move to the Ports box, and then press Up Arrow or Down Arrow to select the desired port.

3. Choose the type of printer.

If necessary, press Tab to move to the list of device types.

Press Down Arrow to highlight the type of printer, then press Return. A list of printers of that type appears in the box on the right.

4. Choose a zone, if necessary.

If your network is divided into zones, their names will be listed. If you want to choose a printer in a different zone, press Tab to move to the list of zones. Highlight the zone that your printer belongs to, then press Return.

5. Choose the particular printer.

Press Tab to move to the list of printers on the right side of the screen.

To choose a specific printer, highlight its name and then press Return. (Be sure to press Return, even if the name of the printer you want is already highlighted.)

❖ *LaserWriter users:* If you've chosen a LaserWriter, you see the message "Checking for presence of ImageWriter emulator." If no one has printed with the printer since it was turned on, you also see the message "Downloading ImageWriter emulator." (The ImageWriter emulator is a program that makes it possible to use a LaserWriter with any application designed to print with an ImageWriter.)

6. Type your name.

Press Tab to move to the "User name" box, then type your name. Some applications use this information to let other people know who is currently using the printer.

❖ *Note:* You can type a name here only when you're using the Chooser from the workstation disk.

7. Quit.

When everything is correct (see Figure 3-4), press Command-Q to quit the Chooser. You see a dialog box asking if you want to save the changes you've just made. If you select Yes, the changes are saved on the disk or on the server. If you select No, the changes will be in effect only until you log off. If you select Cancel, you see the Chooser screen again.

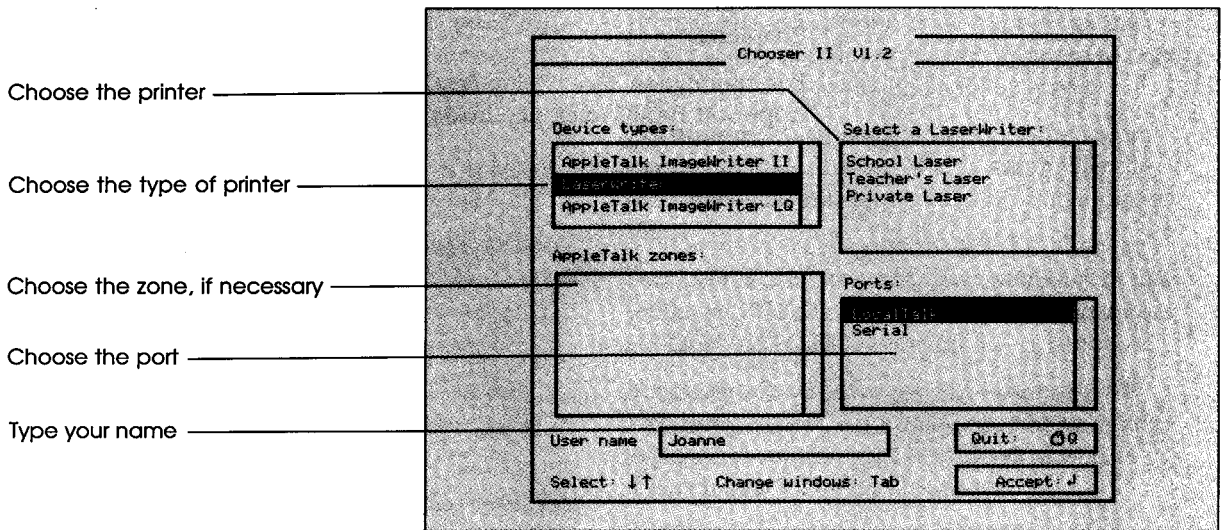

Figure 3-4
Ready to quit the Chooser

Using the System Utilities

If you're experienced with other utilities programs for the Apple II, you can probably use the System Utilities without reading the manual. If you need information about any of the commands, refer to the *Apple II System Disk User's Guide*.

Using other menu choices

The other menu choices are covered elsewhere in this manual.

File Server Log On, explained in Chapter 2, allows you to log on to the server if your workstation is connected to an AppleShare file server. After you log on, you see the disk menu again—an advantage if you want to choose another item before you use the server.

File Server Log Off and Access Privileges are also described in Chapter 2.

For information about using AppleSoft BASIC, refer to any AppleSoft BASIC reference manual.



Glossary

access privileges: The privileges, given to or withheld from users, to open, change, or delete folders that are stored on the server. Through the setting of access privileges, you control the information that you store on the server.

AppleTalk-compatible printer: A printer you can use over an AppleTalk network system.

file server: A specially equipped computer that you can use to store and share information. In this guide, the term *file server* is used interchangeably with *server*.

folder: The secondary organizing unit on the server. A folder on the server is equivalent to a ProDOS subdirectory.

group: A named collection of registered users that is designated by the network administrator.

guest: Someone who uses the server without a user name and password.

lock: To prevent a folder from being renamed, moved, or deleted. You use the Access Privileges program to lock and unlock folders.

log off: To end a work session on the server that you began by logging on.

log on: To identify yourself to the server from a workstation.

network: A system of interconnected computers and peripheral devices, such as printers and hard disks.

password: A word or set of characters that protects the privacy of files or volumes on the server. A registered user may be required to enter a password in order to log on to the server.

pathname: A sequence of names—the volume name, the folder names, if any, and finally the filename—that tells how to identify and locate a file.

PC: Abbreviation for *personal computer*. In this guide, an IBM or compatible computer that uses MS-DOS (or PC-DOS) version 3.1 or later.

ProDOS: An acronym for *Professional Disk Operating System*. An Apple II operating system designed to support hard disk drives as well as 3.5-inch and 5.25-inch disk drives.

random-access memory (RAM): Usually, the part of a computer's memory available for programs from a disk.

registered user: Someone for whom a unique user name, and usually a password, have been assigned.

serial port: A socket to which you connect serial peripheral devices such as ImageWriter printers.

server: A specially equipped computer that you can use both to store and share information. In this guide, the term *server* is used interchangeably with *file server*.

stand-alone computer: A computer that has its own disk drive and that can operate independent of the network.

startup program: A program designated by the network administrator that begins automatically, right after a user logs on. (When the workstation disk is used to start up a workstation, the startup program is bypassed.)

subdirectory: On the server or on disks formatted with the ProDOS operating system, a subdivision of a volume. Equivalent to **folder**.

user name: A unique name assigned to a registered user and used to identify that user on the network.

volume: The main organizing unit on the server.

workstation: A computer that you can use to do your work and to send and receive information over the network.

zone: One or more networks, identified by a specific name for the users' convenience, that are part of a larger, interconnected network.



Index

A

- Access Privileges program 26–32, 35
 - changing privileges with 28–32
- <Any User> 26
- Apple key 18
- AppleShare IIfx Workstation* disk, using 34–44
- AppleSoft BASIC 35
- applications
 - startup 22
 - working copies of 37

B

- back panel adapter box, attaching 2–6
- BASIC 35
- bulletin board (electronic) 28

C, D

- cables. *See* LocalTalk
- card. *See* workstation card
- Chooser 34, 40–43
- choosing printers 40–43
- Command key 18
- Copy a Disk option (FastCopy) 37

E

- electronic bulletin board/mailbox 28
- Everyone category 26
 - assigning privileges to 31

F

- FastCopy utility 35, 37
- file server. *See* server
- File Server Log Off 24–25, 35
- File Server Log On 17, 34
- folders 14–15
 - changing access privileges for 28–32
 - creating 15–16
 - ownership of 32
 - private 16

G, H

- Group category 26
 - assigning privileges to 31
 - guests 16

I, J, K

- ImageWriter. *See* printers
- ImageWriter emulator 42
- installing workstation card 2–10

L

- LaserWriter. *See* printers
- LocalTalk 9–10
- locking folders 26–27, 31
- logging off 24–25
- logging on 16–22
- “Log off from file server” command 25

M

- mailbox (electronic) 28
- Make Changes privilege 27
 - assigning 31

N

- Namer 34, 38–39
- naming printers 38–39
- network 12–13
- network administrator 13

O

- Open Apple key 18
- Owner category 26
 - assigning privileges to 31
 - ownership (of folders) 32

P, Q

- passwords 16, 20
- pathnames 15, 23–24
- ports. *See* LocalTalk
- prefix, setting 23–24
- printers
 - choosing 40–43
 - naming 38–39
- print server. *See* server
- privacy, server and 16
- private folders 16
- privileges. *See* Access Privileges program or *specific privilege*
- ProDOS BASIC 35

ProDOS naming conventions
23-24
programs. *See* applications

R

registered users 16
renaming. *See* naming printers
restarting. *See* starting up
workstation

S, T

See Files privilege 27
assigning 31
See Folders privilege 27
assigning 31
server 12-13
privacy and 16
slot, selecting 2-3
stand-alone computer 12-13
starting up workstation 17-18
startup applications 22
System Utilities program 34, 43

U

user names 16
users, registered 16

V

volumes 14-15
selecting 21-22

W, X, Y

working copies (of applications) 37
workstation 12-13
starting up 17-18
workstation card, installing 2-10
workstation disk. *See AppleShare IIe*
Workstation disk

Z

zones 19, 41

THE APPLE PUBLISHING SYSTEM

This Apple manual was written, edited, and composed on a desktop publishing system using Apple Macintosh® computers and Microsoft® Word. Proof pages were created on the Apple LaserWriter® Plus. Final pages were created on the Varsity® VT600™. POSTSCRIPT®, the LaserWriter page-description language, was developed by Adobe Systems Incorporated. Some of the illustrations were created using Adobe Illustrator™.

Text type is ITC Garamond® (a downloadable font distributed by Adobe Systems). Display type is ITC Avant Garde Gothic®. Bullets are ITC Zapf Dingbats®. Some elements, such as program listings, are set in Apple Courier, a fixed-width font.



Apple Computer, Inc.

20525 Mariani Avenue
Cupertino, CA 95014
(408) 996-1010
TLX 171-576

030-3115-A
Printed in Singapore.