

I. O. SILVER  
 PROOF OF PURCHASE  
 (See for disk or manual updates)



## More Beagle Bros Apple Software

(WHAT'S NEW? Check our ads in *4+*, *Call-A.P.P.L.E.*, *inCider*, *Nibble* and other Apple® magazines.)

### ■ GRAPHICS ■

- **ALPHA PLOT** (1+; 16K) ..... \$39.50  
Normal hi-res (6 colors, 280x192 pixels) drawing and printing on both hi-res pages. Compress pictures to 1/3 disk space.
- **APPLE MECHANIC** (1+; 16K) ..... 29.50  
Create hi-res shapes for animation with Applesoft's DRAW & XDRAW commands. Put fancy hi-res type in your programs. List & learn demo programs teach you hi-res programming.
- **APPLE MECHANIC TYPEFACES** ..... 20.00  
25 new editable fonts to be used with Apple Mechanic.
- **BEAGLE GRAPHICS** (1+; 128K) ..... 59.95  
Double hi-res drawing (16 colors, 560x192 pixels) and printing in many typesizes (all editable). Color fill, cut & paste, 200+ color mixes, 33 new commands for using double-hi-res in your programs. Convert normal hi-res pictures and programs to double hi-res, compress mix to 1/3 disk space...
- **FLEX TYPE** (1+; 16K) ..... 29.50  
Variable-width text (wide, normal, condensed) controllable with normal Applesoft commands. No 80-column card read.
- **FRAME-UP** (1+; 16K) ..... 29.50  
Make Apple "slide shows". Keyboard controlled or unattended, using your existing hi-res, hi-res and text screens.
- **TRIPLE-DUMP** (1+; 16K) ..... 39.95  
Transfer any image, including double hi-res, to your dot matrix printer. Make Giant (8" high characters) Banners too.

### ■ ALL-PURPOSE ■

- **DISKQUICK** (1+; 128K) ..... \$29.50  
Acts like half a disk drive in slot 3. Silent and fast as a hard disk. Load/save files in memory with normal commands.
- **FATCAT** (1+; 16K) ..... 34.95  
Reads all of your DOS 3.3 and ProDOS file names into one or more Master Catalogs for sorting, searching and printing. Alphabetize file names on disks. Compare any two files.
- **PRONTO-DOS** (1+; 16K) ..... 29.50  
Triples the speed of loading and saving. New TYPE command displays text file contents. Move DOS for extra 10K.

### ■ PROGRAMMING ■

- **BEAGLE BASIC** (1+; 64K) ..... \$34.95  
Puts Applesoft in RAM so you can change it and add enhancements—new commands like *HEX-ELSE*, *SWAP* variables, *GOTO*/*COSIB-a-variable*, *TONE*, *HSCRN*, etc.
- **D CODE** (1+; 16K) ..... 39.95  
Compact Applesoft programs and reveal unused code. Auto-proofread Applesoft programs, even as you type. Trace any number of program statements *after* stopping a program...
- **DOS BOSS** (1+; 16K) ..... 24.00  
Reword DOS 3.3 commands. Change "Catalog" to "Cat". Syntax Error to "Oops" or anything. Includes many handy tips for altering DOS, including program "save-protection".
- **DOUBLE-TAKE** (1+; 16K) ..... 34.95  
2-way scroll for listings & catalogs. Better List-format, fast variable+line number display, better renumber/append, auto line-numbering, instant hex/dec converter and more.
- **CPLE** (1+; 16K) ..... 49.95  
Edit Applesoft without cursor-tracing. Features insert & delete and fast search & replace. Make all keys be "function keys" to type anything you like (ESC-1 catalogs disk, etc.). Move DOS 3.3 out of main memory to add 10K of space.
- **SILICON SALAD** (1+; 16K) ..... 24.95  
Over 100 utilities and tricks—hi-res program splitter, DOS killer, disk scanner, hi-res text impinger, 2-track catalog...
- **TIP DISK # 1** (1+; 16K) ..... 20.00  
100 tips on disk from Tip Books 1-4. Fascinating Apple programming techniques. Includes Apple Command Chart.
- **UTILITY CITY** (1+; 16K) ..... 29.50  
21 utilities—Last-formatter puts each statement on a new line, multi-column catalogs, invisible/trick file names, etc.

### ■ GAMES ■

- **BEAGLE BAG** (1+; 16K) ..... \$29.50  
12 games on one disk. Voted to 1983's MOST POPULAR list in *Softalk* poll. The best Apple game bargain on the market.
- **I. O. SILVER** (1+; 16K) ..... \$29.95  
Two games in one—a great strategy game and a fast action arcade game. Superb unlocked machine language graphics.

(Subject to change—See our current ads or catalog.)  
 \*APPLE is a Registered Trade Mark of Apple Computer, Inc.

† Supports DOS 3.3 only  
 \* Supports both DOS 3.3 and ProDOS™

I. O. SILVER™, Copyright © 1984, Brad Wilhelmsen

ISBN 0-917085-09-4

Published by BEAGLE BROS MICRO SOFTWARE, INC.  
 3990 Old Town Avenue, San Diego, California 92110

\*APPLE is a registered trade mark of Apple Computer, Inc.

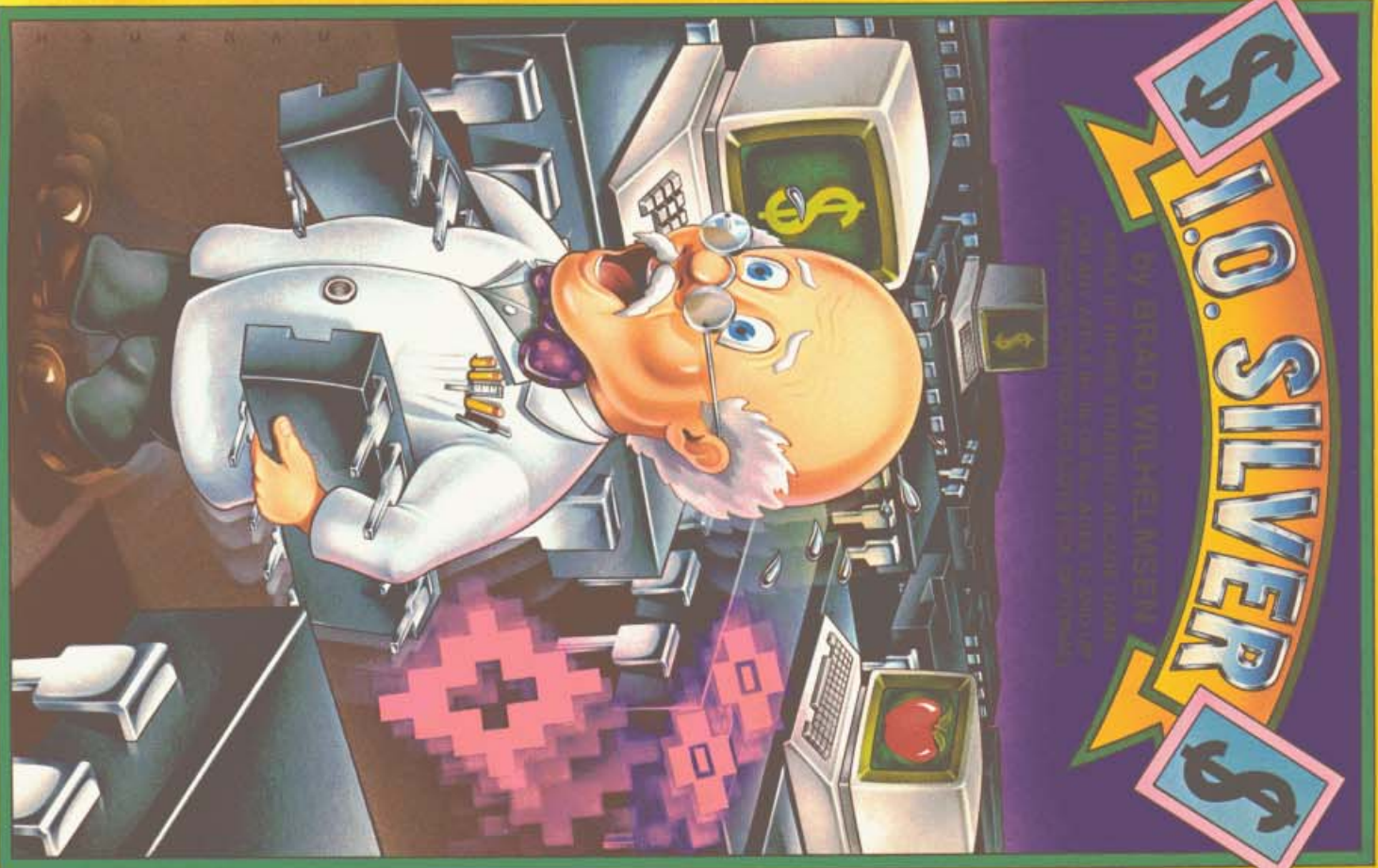

BEAGLE BROS PRESENTS

\$ I.O. SILVER \$

THE I. O. SILVER DISK IS UNLOCKED (INSPECTABLE) AND UNPROTECTED (COPYABLE)



**I. O. SILVER**

Copyright © 1984, Brad Wilhelmson

ISBN 0-917085-09-4

Programmed by Brad Wilhelmson  
 Instruction Manual by Bert Kersey  
 Cover Illustration by John Hamagami

Published by  
 Beagle Bros Micro Software, Inc.  
 3990 Old Town Avenue  
 San Diego, California 92110

**Table of Contents**

**INTRODUCTION**

Object of the Game ..... 3  
 Summary of Game Controls ..... 4  
 Summary of How to Play ..... 5

**GAME FEATURES**

Disk Menu and Main Menu ..... 6  
 The Playing Screen ..... 9  
 Moving the Professor ..... 11  
 Combining Parts ..... 12  
 Levels and Execution Points ..... 13  
 Earning Money and Execution Points ..... 14  
 The Bugs ..... 15  
 The Annual Report ..... 16  
 Saving a Game In-Progress ..... 18  
 The Strategy Lab ..... 18

**TIPS ON PLAYING THE GAME** ..... 19

**APPENDIX**

Technical Information ..... 20  
 Source Code Information ..... 20

**Registration Card**

Mailing this card assures you of being on our list for upcoming issues of the *Beagle Bros Bulletin* as well as any important Update Notices regarding your software. The postage is free, so fill it out now, and MAIL IT TODAY, even if you've registered before.

**PRODUCT NAME**

(If you received this product FROM BEAGLE BROS BY MAIL, you are already registered—no need to mail this card.)

**YOUR NAME**

**ADDRESS**

**CITY**

**STATE & ZIP**

—optional—

What other Apple-related products would you like to see us produce?

Is lack of copy-protection a factor you consider when buying software? (Y/N): \_\_\_\_\_

Beagle Bros will continue producing low-priced unprotected software as long as our customers support us by not giving copies of our products away. Are you with us on this? (Y/N): \_\_\_\_\_

Other Comments: \_\_\_\_\_

# I. O. SILVER

by Brad Wilhelmsen

## INTRODUCTION

I. O. SILVER is a hi-res strategy/arcade game for the Apple II series of computers. Dr. I. O. Silver is a semi-world famous hi-res scientist and renowned hardware nut. The Professor is forever attempting to build the new fifth generation "Super Computer" from the array of integrated circuits (computer chips) on the Apple screen. Your job is to help him out.

## HARDWARE REQUIREMENTS

The only hardware required to play I. O. Silver is any version of Apple II and a disk drive. Well, o. k., you do need a monitor—a color monitor will add color to the game, but a non-color screen will work just as well. If you have a monochrome monitor (green screen, black-and-white, etc.), you can discern the different colors by the patterns on the playing pieces. Whenever we refer to "color" in these instructions, we also mean "pattern".

You can play the game using only the keyboard (our favorite way), but a joystick is an optional accessory (and besides, after a few years, if you tire of the game, the I. O. Silver disk and a joystick can be used for a rousing game of floppy ring toss).

## BACK IT UP

In keeping with Beagle Bros tradition, the I. O. Silver disk comes from the factory unlocked and unprotected. "Unlocked" means that if you're into machine language—or would like to be—you can inspect or change the game to see what makes it work. "Unprotected" means you can copy the disk with the standard Apple copy program that came with your Apple. That way if your original disk fails (or falls into the fish tank), you've got a replacement. Make a backup of the disk now; we'll wait here.

## US CRAZY? NO WAY, JOSE!

Selling a copyable game disk is considered by some in our industry to be what's known as—in business terms—a "dumb move". We heartily disagree, and believe that making software more friendly makes it a more valuable product to you, our valued customer. Please support our efforts by not giving copies away to your friends. Every illegal copy you see or use is a vote FOR copy protection and AGAINST friendly software. You support us, and we'll support you.

## SOURCE CODE AVAILABLE

Some of you advanced programmers might be interested in obtaining the source code for I. O. Silver. If so, check the Appendix (page 20).

## The Object of the Game

### GET RICH BY PUSHING CHIPS!

The object of I. O. Silver is to move the Professor around the screen and push together all of the chips of the *same color*, thus combining them and creating other parts which ultimately create a Super Computer. For each Super Computer built, you get a hi-res medal and tons of imaginary cash.

Short of that lofty goal, the object is to survive and earn as much money as possible by combining as many chips and other computer parts as you can. High scores are saved on disk at the end of each game. Besides getting the all-time highest score (and becoming famous), there is no way to actually "win" the game.

### DE-BUGGERS WANTED

You will work within a one simulated-year deadline and constantly be harassed by a gang of computer "bugs" which will try and rob you of your most valuable asset—time. You can, however, earn even more money by trapping these pesky critters.

### TWO WAYS TO PLAY

You may play two different versions of I. O. Silver—the high-pressure "ARCADE WORKSHOP" or the take-your-time "STRATEGY LAB". See page 6 for details.

### WE NEVER SAID THIS GAME WAS EASY

Actually, playing I. O. Silver is easy. Creating the Super Computer, however, is pretty difficult and may even seem *impossible* at first, until you get a feel for the game and develop a working plan.

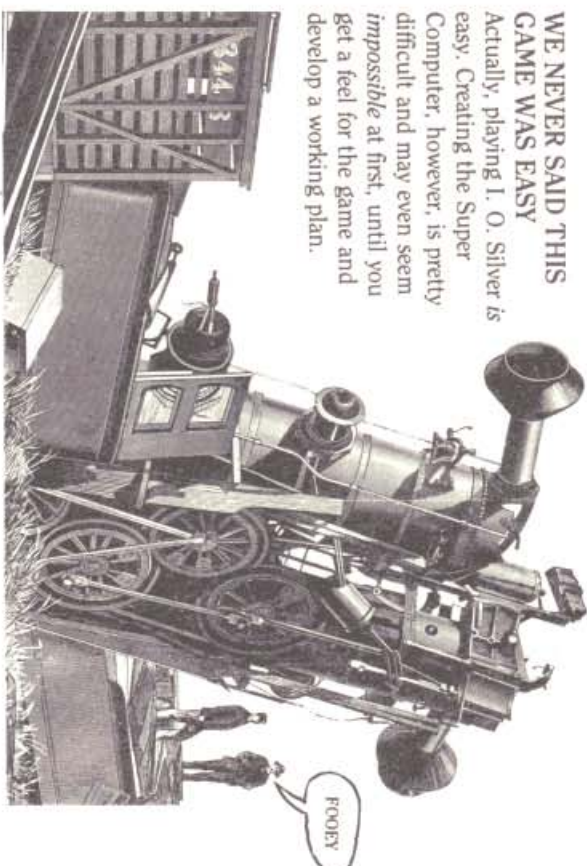



## Summary of Game Controls

### KEYBOARD MODE—

- I, J, K or M:** Moves or turns the Professor, OR pushes (if not blocked) the adjacent chip that the Professor is facing—up, left, right or down.
- CONTROL-C:** Lets you change from I/J/K/M to another set of keys.
- CONTROL-A:** Switches to joystick (instead of keyboard) control during the game. You may adjust your joystick when the switch is made.

### JOYSTICK MODE—

- JOYSTICK STICK:** Moves or turns the Professor in the direction selected.
- JOYSTICK BUTTON** (either one): Pushes (if not blocked) the adjacent chip that the Professor is facing.
- CONTROL-C:** Lets you adjust your joystick for proper centering.
- CONTROL-B:** Switches to keyboard (instead of joystick) control during the game. You may optionally change from I/J/K/M to another set of keys when the switch is made.

### BOTH MODES—

- CONTROL-S:** Toggles the sound on and off during the game. (Remember, if you have an Apple with a volume control, be sure the volume is not all the way down if you want sound.)
- ESC:** Ends the current level (Note: The Arcade Workshop version requires at least as many execution points as the level number to end a level—page 13).
- RETURN:** Lets you take a vacation and study the screen to plan your next set of moves (Arcade Workshop only).
- CONTROL-RESET** (not recommended): Stops everything in its tracks and forces you to re-boot a disk.

## Summary of How to Play I. O. Silver

(The small numbers like “15” are page references for more information.)

### GETTING STARTED—

- **BOOT THE DISK** by inserting it in your main drive and turning on your Apple. You will see the Disk Menu with its I, O and S options.<sup>5</sup>
- **PRESS “I”**—You will soon see the game’s Title Screen.
- **PRESS ANY KEY** when the drive stops—You will see the main menu.<sup>6</sup>
- **PRESS “I”** to play the Arcade Workshop version<sup>6</sup> of the game (or select one or more of the other options).<sup>6</sup> You will see the chip values.<sup>8</sup>
- **PRESS ANY KEY** and you will see the Laboratory (playing screen).<sup>9</sup>

### PLAYING THE GAME—

Some Rules Before You Start: I. O. Silver is played on advancing “levels”<sup>13</sup> numbered from 1 to 26. You have a one year time limit on each level, indicated by the calendar<sup>4</sup> at the top of the screen. If time runs out, it costs you one Professor.<sup>13</sup> You are given three Professors to start the game (you only play with one at a time).

■ **PRESS ANY KEY** to release the bugs and begin playing the game. Move the Professor<sup>11</sup>, dodging the bugs as much as possible. Push the chips<sup>11</sup> to combine as many of the *same color* (and pattern) as you can. When all the chips of one color are combined, they become a “circuit board,”<sup>12</sup> which may be combined to create other parts,<sup>12</sup> which ultimately, if you’re good enough, will combine down to become one object—the Super Computer, earning you a well-deserved medal and the biggest prize money.

Each chip combination and new object created (like a circuit board) earns you money. You may also trap bugs<sup>15</sup> between chips to earn more money and, at least temporarily, get them off the screen.

Creating any new part (like a circuit board) gains you one or more “execution points.”<sup>13</sup> If the number of execution points equals or exceeds the current level number, you may press ESC and go on to the next level,<sup>13</sup> where you will start over with a new batch of chips. OR you may continue earning money by building on the current level.

If time runs out (on DEC.31), the level will end and you will get to replay the same level (unless you have used all three of your Professors;<sup>13</sup> then the game is over).

Your earnings and the number of Professors remaining will be reported between levels in an “annual report.”<sup>16</sup> High scores and in-progress games may be saved on disk.<sup>18</sup>

## Features of the Game

### ■ THE DISK MENU

This menu will appear when you turn on your Apple to boot the disk:

- (I) PLAY I. O. SILVER
- (O) OTHER STUFF
- (S) STOP FOR NOW

"Other Stuff" is self-explanatory; try it sometime. "Stop for Now" is rather boring and not recommended. PRESS THE "I" KEY to play I. O. Silver.

### ■ THE MAIN MENU

When you see the game's title screen and the disk drive stops, PRESS ANY KEY and the following list of options will appear:

1. ARCADE WORKSHOP
2. STRATEGY LAB
3. SEE HIGH SCORES
4. SEE SAVED GAMES
5. SELECT JOYSTICK (or ADJUST JOYSTICK)
6. CHANGE KEYS (or SELECT KEYBOARD)
7. SOUND: ON (or SOUND: OFF)
8. TV: COLOR (or TV: MONOCHROME)
9. QUIT

At this point you may simply PRESS "1" OR "2" to play the game, or make adjustments by selecting one or more of the other options. Following is an explanation of all the Main Menu options.

### *Options 1 and 2—*

Select one of these two options (press "1" or "2") to start playing a game. You decide which of these two versions of I. O. Silver is for you:

#### ARCADE WORKSHOP

This version of I. O. Silver has more action. It is also more pressure-packed, since you are given a firm deadline and a room full of "bugs" that are out to zap you and bring that deadline even closer.

#### STRATEGY LAB

This version of I. O. Silver puts no time limit on you—you can take all day to make a move—and bugs are prohibited. After trying the game both ways, the Strategy Lab may be the only version you want to play. Or you may want to use it to practice or to plan an attack that can be used in the Arcade Workshop. (see page 18 for more details)

### *Option 3—SEE HIGH SCORES*

This option lets you look at the highest Arcade Workshop scores (if any) that have been saved on the disk that is currently in your main drive.

### *Option 4—SEE SAVED GAMES*

This option lets you see a list of up to ten in-progress Arcade Workshop games that were saved (by you) on disk. You can select one of these games (thus removing it from the disk), if any exist, and continue playing it at the point from which it was saved.

### *Option 5—SELECT (or ADJUST) JOYSTICK\**

This option lets you control the game with a joystick (instead of the Apple keyboard), or adjust it if it's already selected. (When the disk is first booted, the keyboard is automatically the controlling device.)

### *Option 6—SELECT (or CHANGE) KEYBOARD\**

This option lets you play with the keyboard (instead of a joystick). If the keyboard is already selected, you may use this option to change the keys—I, J, K and M—that control the game. (Beagle Bros is *not responsible* for injuries suffered when using the I/J/K/M configuration.) The four arrow keys (found on some Apples) are an obvious, but BAD alternate key choice, we think, because of the way they are positioned on the keyboard. You might like to try two-handed operation by choosing A & Z (up & down) and the left & right arrows (left & right).

### *Option 7—SOUND: ON (or OFF)\**

To toggle the sound on and off, press the "7" key. If you hear a tone, I. O. Silver will be played with a variety of beeps, buzzes and music. Don't forget—if your Apple has a volume control, turn up the volume.

### *Option 8—TV: COLOR (or MONOCHROME)*

If you select Monochrome, the game will simply be played with more contrasting colors. Both versions work with both kinds of monitors.

### *Option 9—QUIT*

This option will let you boot a disk.

\* You may also control this feature while the game is running. See SUMMARY OF GAME CONTROLS on page 4.

## Chip and Bug Values

Before each level begins, you will be shown the values for combining chips and trapping bugs. The screen will look something like this:

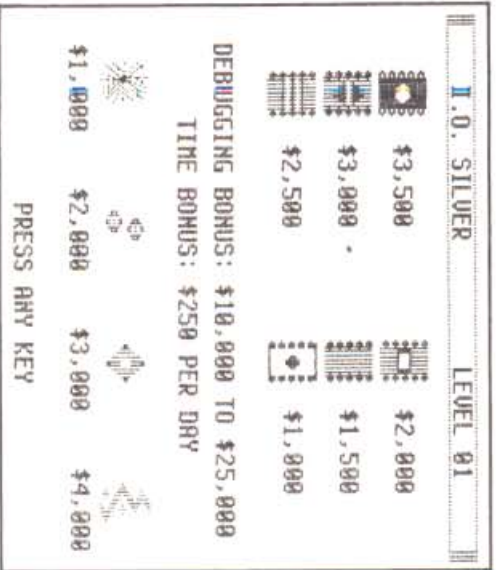

At the top right is the upcoming level number. Under that are the six different color chips and the values that will be obtained by combining two chips of that color. The "De-Bugging Bonus" is the amount earned if you can end a level with no bugs (page 15). The "Time Bonus" is the amount you will earn for each day remaining on the calendar when you end a level. The values under the four bugs at the bottom are the amounts earned for trapping each one.

The values shown on this screen increase on each level. The values for combining parts other than chips (like circuit boards) do not increase. See page 14 for these values.

## The Playing Screen

The I. O. Silver playing screen consists of a one-line scoreboard at the top and a laboratory full of chips below:

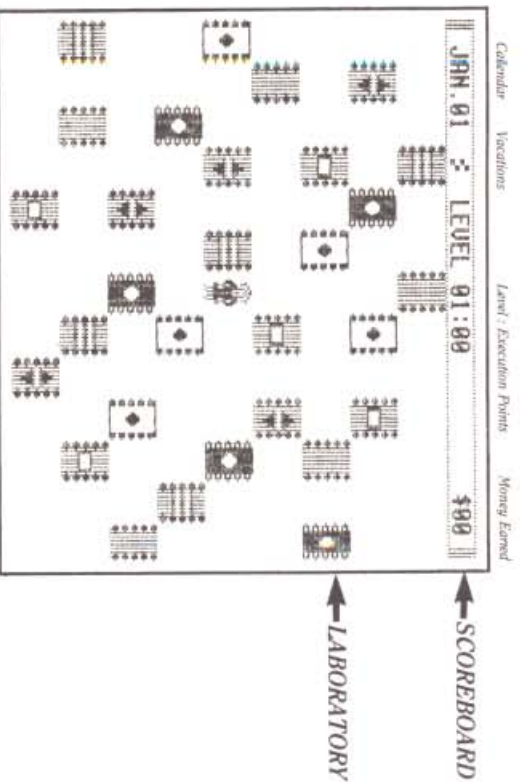

### THE SCOREBOARD

At the top of the screen there are four indicators of the progress of the game at the current level:

**CALENDAR (Arcade Workshop only):** On the left is the calendar. It begins at "JAN.01". When it reaches "DEC.31", the level ends. When you are zapped by a bug, the date will increase by a number of days, depending on which bug was the culprit (page 15).

**VACATION INDICATOR (Arcade Workshop only):** To the right of the calendar are four small dots. These dots show how many vacations you have remaining in the current level (see RETURN on page 4).

**LEVEL NUMBER:** To the right of the vacation indicator is the current level number, a colon and the number of execution points earned so far (page 13).

**MONEY EARNED:** At the far right is the amount of money earned so far on the current level. It is not the total score for the whole game. That will be printed as "Career Earnings" in each annual report (page 16).

## THE PLAYING SCREEN (continued)

### THE LABORATORY

Below the scoreboard is the laboratory itself, a field of computer chips ready to be pushed and assembled by the Professor. There are three main things you must know about this imaginary workshop:

- The Professor is not strong enough to get two chips moving at the same time. Therefore, you cannot push a chip when there is another chip (of a different color) blocking it.
- Everything "wraps around" in every direction—the movement of the bugs, the chips and the Professor. Think of the screen as a flattened-out "sphere" if you want. This means that if you're near the bottom of the screen, the fastest way to the top is down. The fastest way from far left to far right is left. And so on.
- Last but not least, **YOU MUST BE CAREFUL** when you push a chip to make sure there is another one in its path to stop it. If there isn't, the pushed chip will keep going, wrap around the screen and **CRUSH YOUR BODY**, forcing an early retirement and ending the current level with one Professor down the drain. Painful and embarrassing.

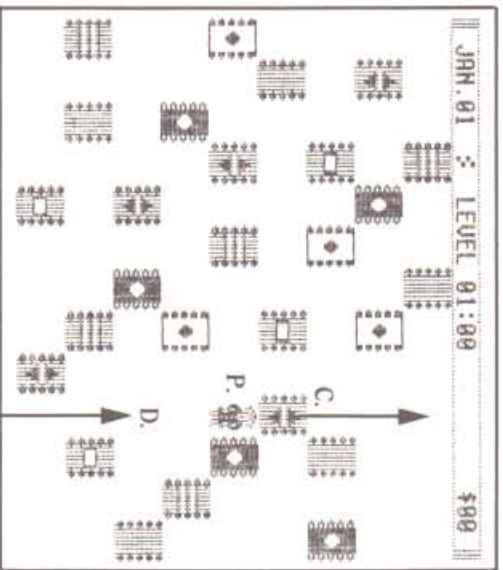

*If the Professor (P) pushes the chip (C) upward, it will wrap around and DESTROY him (D).*

## Moving the Professor and the Chips

Practice makes perfect. Or so they say. You will probably learn more by messing around with the game than by reading this page. Read it anyway.

### KEYBOARD CONTROL

Pressing the I, J, K or M key will cause the Professor to walk up, left, right or down, respectively. He will walk (or at least turn) in the direction selected until he runs into a chip, or until you press another direction key. You may press a key a little in advance of a move, and the Professor will remember. Sorry, no stopping between chips.

Once the Professor has stopped at a chip, you may press the direction key again to push that chip (if another chip isn't blocking it). Or press one of the other keys (I, J, K or M) to walk (or at least turn) in another direction.

If you are using an Apple like a IIc or IIe (with a built-in repeat-key function), **DO NOT HOLD THE KEY DOWN** when you move the Professor. If you do, he will walk up to a chip **AND** push it. This is something you will often not want to do. All moves in this game, intentional or not, are irreversible.

If you don't like the I/J/K/M configuration, change it from the main menu before the game starts, or by typing **CONTROL-C** during the game.

### JOYSTICK CONTROL

The joystick works much like the keyboard (see above). The stick moves the Professor, and either button pushes a chip. Just a slight push of the joystick will move (or at least turn) the Professor in the direction selected. Once you see movement, let the stick spring back to its center position. Pressing either one of the buttons on the joystick will push an adjacent chip (if another chip isn't blocking it) in the direction the Professor is facing.

If the Professor keeps going a direction you don't want him to, your joystick may not be centered properly. Try adjusting it by pressing **CONTROL-C** during the game. If this method fails, you'll have to use the keyboard.

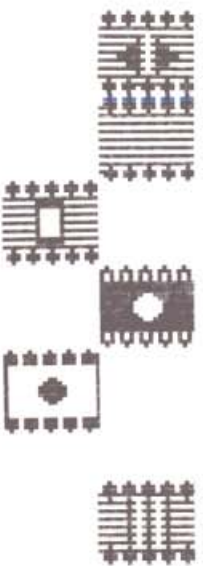

## Combining Parts

When a level starts, the object is to combine as many same-color chips as possible, eventually making other "advanced parts". (Every part other than a chip is referred to as an "advanced part".) Ultimately, when there is only one shape left, you've got the Super Computer.

Each time you combine two same-color chips into one, you earn a certain amount of money. When all of the chips of one color have been combined, they become a new part—a CIRCUIT BOARD. Circuit boards combine with other circuit boards and parts (but not with chips) to make other advanced parts, which combine to eventually make a Super Computer.

You have the opportunity to build one Super Computer on every level. Each time you do, you will receive a Medal. Your Medals will be prominently displayed in the annual report and tallied on the high score screen.

### I. O. SILVER PARTS LIST

#### CHIPS—

White  
Black  
Green  
Violet  
Orange  
Blue

(start each level with 5 of each)

REMEMBER:  
Just combine all of  
THE CHIPS and then all  
of the ADVANCED PARTS  
until you've got one part left—  
THE SUPER COMPUTER!

#### ADVANCED PARTS—

Circuit Board (made from 5 chips of the same-color)

Calculator  
Micro Computer  
Mini Computer  
Mainframe Computer  
Super Computer

(Each of these parts is made from  
any two other advanced parts.)

#### WE REPEAT (in case you've been asleep):

- ONLY MATCHING-COLOR CHIPS MAY BE COMBINED.
- ADVANCED PARTS COMBINE WITH ANYTHING EXCEPT A CHIP.

## Levels and Execution Points

When you start the game, you will play on Level 1. If you complete Level 1, by earning enough "execution points", you will advance to Level 2—starting over with a different arrangement of chips—on up as high as you can go (26 is the highest level, and probably impossible; let us know).

### COMPLETING A LEVEL

To successfully complete Level number  $x$ , you must earn  $x$  execution points. Execution points are earned by turning one or more types of parts into another. For example, if you push the last two black chips together to make a circuit board, you will earn 1 execution point, enough to complete Level 1. If you build 2 circuit boards, you get 2 execution points, enough to complete Level 2. Creating other types of parts is worth even more (page 14). All of these accomplishments also earn you big bucks, but money is not directly a factor in completing a level.

When the number of execution points totals the current level number, the two numbers after "Level" at the top of the screen will match, a special sound will play, and you will (undoubtedly) feel a warm glow of satisfaction. But the level does not automatically end at this point. You have two options—hit the ESC key to quit the level and earn a bigger Time Bonus, or keep playing to build more of the Super Computer.

Some Free Advice: Push two circuit boards together whenever possible. Apart they are worth 2 execution points, but pushed together (making a calculator), they are worth 4 points, enough to complete Level 4. This is much easier than trying to make 4 circuit boards.

### FAILING TO COMPLETE A LEVEL

- If the calendar hits "DEC.31" before you have enough execution points, you will lose one of your 3 Professors and have to replay that level. IF you have any Professors left, that is. If you don't, the game ends.
- If there are no possible moves left (if there are no chips in line with each other and no chips can be pushed) the level ends.
- The worst way to end a level is by pushing a chip which is not in line with any other. The chip will wrap around the screen AND CRUSH YOU, forcing you to play that level again, regardless of the number of execution points earned so far in that level. Any Time Bonus or De-Bugging Bonus you earned will be lost. You will also lose one Professor. You will become depressed.



## Earning Money and Execution Points

The primary goal of I. O. Silver is to earn money. Earning execution points is important too, since they let you advance to the next level, thus buying you more time and increasing the values for combining chips and trapping bugs (see next page).

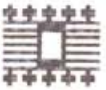

### CHIPS

Money Earned for Combining 2 of Same Color: Varies for each level  
Execution Points: None



### CIRCUIT BOARD

Made From: 5 chips of the same color  
Money Earned for Creating: \$25,000  
Execution Points: 1  
Time Earned: 2 Months (*Big Bonus!*)

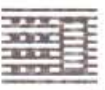

### CALCULATOR

Made From: 2 circuit boards  
Money Earned for Creating: \$50,000  
Execution Points: 2

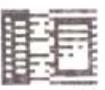

### MICRO COMPUTER

Made From: A circuit board and a calculator  
Money Earned for Creating: \$100,000  
Execution Points: 3



### MINI COMPUTER

Made From: A micro computer and a circuit board  
Or 2 calculators  
Money Earned for Creating: \$250,000  
Execution Points: 4

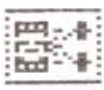

### MAINFRAME COMPUTER

Made From: A mini computer and a circuit board  
Or a calculator and a micro computer  
Money Earned for Creating: \$500,000  
Execution Points: 5



### SUPER COMPUTER

Made From: A mainframe computer and a circuit board  
Or a mini computer and a calculator  
Or 2 micro computers  
Money Earned for Creating: \$1,000,000  
Execution Points: 6

## The Bugs

These are not your garden variety of crawly bugs, but the kind that prowl the computer world. When you are touched by a bug, you do not lose the game and the level doesn't end. What you do lose is time (sound familiar, programmers?). And your one-year deadline gets closer.

The best defense against the bugs is to AVOID THEM. Your only anti-bug weapons are the chips and other parts. Smashing a bug between two chips of different colors will trap it temporarily. You will earn from \$1,000 to \$4,000 on Level 1 for doing this kind of "error trapping". (The point values for the bugs, like the chips, increase each level.) However, if you later move either of the chips that a bug is trapped between, it will escape.

### DE-BUGGING BONUS

Another more effective (and more profitable) way to eliminate a bug is to trap it between two chips of the same color. You will earn double value for combining the chips. Smashing two bugs at the same time triples the dollar value, smashing three quadruples it, and four bugs quintuples the money earned. Plus you also get a big De-Bugging Bonus if you can end a level with all of the bugs gone. But watch out—if you get zapped by a bug, all trapped bugs will be released.



#### Bug #1: The SOFTFAIL

Appearance: White Sparkler  
Time Lost if Zapped: One Week  
Reward for Trapping: \$1,000\*

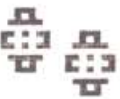

#### Bug #2: The INFINITE LOOP

Appearance: Spinning Diamonds  
Time Lost if Zapped: 2 Weeks  
Reward for Trapping: \$2,000\*



#### Bug #3: The OVERFLOW

Appearance: Pulsating Orange Diamond  
Time Lost if Zapped: 3 Weeks  
Reward for Trapping: \$3,000\*







#### Bug #4: The SURGE (*very dangerous!*)

Appearance: Blue Lightning Bolt  
Time Lost if Zapped: 1 Month  
Reward for Trapping: \$4,000\*

\* Amount increases on succeeding levels

## The Annual Report

At the end of each level, you will be shown an Annual Report, looking something like this:

I. O. SILVER		ANNUAL REPORT			
LEVEL COMPLETED:	03				
EXECUTION POINTS:	04				
PUSHES:	26				
UNUSED CHIPS:	19				
BUGS TRAPPED:	02				
TIMES ZAPPED:	16				
VACATIONS:	03				
DAYS REMAINING:	189				
TIME BONUS:	\$56,780				
DEBUGGING BONUS:	\$00				
TOTAL INCOME:	\$185,980				
CAREER EARNINGS:	\$370,500				
PRESS ANY KEY					
HIT ESC TO SAVE GAME					

The Annual Report is a summary of how well you did on each level. Here is a rundown of each of the Annual Report categories:

### NUMBER OF PROFESSORS *(pictured)*

The number of Professors remaining are pictured at the top right of the screen. At the start of the game you have 3. You lose 1 every time you do not complete a level. You get another Professor (up to 8 maximum) every time you complete an even-numbered level, beginning with Level 2.

### NUMBER OF MEDALS *(pictured)*

Every time you build a Super Computer, you get a Medal. Your Medals will be pictured below the Professors.

### LEVEL COMPLETED

The most recent level completed.

### EXECUTION POINTS

This number indicates how many execution points were earned on the most-recent level. If the execution points are greater than or equal to the level number, then you have completed the level. The only exception is if you smashed yourself with a chip. Then you must play the level again.

### PUSHES

How many times you pushed a chip on the previous level.

### UNUSED CHIPS

This number shows how many chips remained when the level ended. If you pushed all of the chips together into circuit boards, the number would be 00.

### BUGS TRAPPED

How many bugs you trapped on the previous level.

### TIMES ZAPPED

How many times the bugs got you.

### VACATIONS

How many vacations you used.

### TIME BONUS

This amount is earned by quitting a level with days remaining on the calendar. The Time Bonus begins at \$250 a day on Level 1, and goes up \$25 per day for each level.

### DE-BUGGING BONUS

This amount is earned by ending a level with all of the bugs trapped. \$10,000 is the reward. You get a \$25,000 bonus when ALL of the bugs have been smashed between chips of the same color. If any bugs are loose, the bonus is zero.

### TOTAL INCOME

This amount is all of the money earned on the previous level. When you begin the next level, this value goes back to zero.

### CAREER EARNINGS

This amount is the sum of all earnings so far in the game. At the end of the first year, Total Income and Career Earnings will be the same amounts. After that, Career Earnings will (hopefully) be larger.

## Saving Games In-Progress

When you are in the Arcade Workshop, you can save the game in progress at the end of any level. You might want to do this just to take a break. Or you might want to go to the Strategy Lab (via the main menu) to try out the next level.

### IMPORTANT: *DON'T SWITCH DISKS. YOU MUST SAVE IN-PROGRESS GAMES ON THE I. O. SILVER GAME DISK.*

Press the ESC key when you see "Hit ESC to save game" (at the end of a level only). Enter your name (or any word, up to eight characters), press RETURN and your game will be saved to the disk. (Be sure you have a good, DOS 3.3, non-full, non-write-protected disk in the drive, with the drive door closed. If you don't, you'll get a "Disk Error" message.)

When you want to continue a saved game, choose item 4, "See Saved Games", from the main menu. Enter the letter of the game you want to play, and you will automatically enter the Arcade Workshop. That game will be deleted from the Saved Game list. Of course, you can save it again at the end of the next level.

A total of ten games can be saved. If you try to save an eleventh game, you will first be asked to select a game to be dropped from the list. If you don't want to lose any of the previously saved games, press ESC to keep on playing the current game.

## Strategy Lab Differences

As we mentioned before, you may choose to play I. O. Silver's "Strategy Lab" version by selecting it from the main menu (page 6). The Strategy Lab is less hectic than the Arcade Workshop. There is no calendar, no deadline and no bugs. You can relax and play at your own speed. Each level in Strategy Lab is identical to the same level number in the Arcade Workshop. You can plan your attack here, and then tackle the Arcade Workshop. Or you may want to play the Strategy Lab exclusively. A lot of people do.

Before going in the Strategy Lab, type the level you want to play. You can choose any level from 1 to 26. You may leave the level at any time by pressing ESC (no execution points are needed here).

A level will end when you press ESC, or when there are no possible moves left, or when you smash yourself with a chip.

Strategy Lab games cannot be saved.

## Tips on Playing I. O. Silver

Here are some general strategies that will help you enjoy the game, get higher scores, and impress your friends:

- **DON'T PUSH CHIPS RANDOMLY.** In fact, don't push a chip AT ALL unless it fits in with a plan of aligning and combining with other chips. You can't take moves back, and it's easy to get carried away trying to smash bugs. But you cannot complete a level just by smashing bugs; you must build circuit boards and earn execution points.
  - **NEVER CREATE A BLOCK OF FOUR CHIPS.** The chips will become locked together and you won't be able to push them, making it very difficult or impossible to complete a level.
  - **CONCENTRATE ON CHIPS OF ONE COLOR.** Decide to combine all of, let's say, the white chips (these have the highest point value) to make a circuit board. Then, take a vacation and study the screen for a new plan.
  - **WAIT FOR THE BUGS TO COME TO YOU.** The best way to smash bugs is to find a push that helps you strategically, and wait for a bug to enter the line of fire.
  - **TAKE ADVANTAGE OF WRAP-AROUND.** If a chip looks blocked, don't give up. Maybe you can move it to an advantageous position by pushing it in the opposite direction.
- Remember that two chips at opposite edges of the screen are actually touching each other. Also, don't waste time running across the screen to get to the other side.
- Hanging around the center of the screen will keep you from being attacked from the "blind side" by bugs.
- **USE NON-VACATION PAUSES FOR LUNCH BREAKS.** Rather than use up your valuable vacations, press CONTROL-C. This will put you in the keyboard or joystick adjust mode and temporarily stop the game, not costing any vacation time. The only problem is, you can't see the Lab.
  - **DON'T FORGET THE ESC KEY.** This will quit the level when you have enough execution points. If the position looks bad, take the Time Bonus for any remaining days on the calendar.
  - **WAIT TO COMBINE PARTS.** The fewer the number of parts left on the screen, the more difficult the game becomes. With this fact in mind, don't push parts together unless necessary. Just get them lined up with each other. When you are ready, try to make a clean sweep. Author's note: This is easier said than done. Good luck!



## Appendix

### TECHNICAL STUFF ABOUT THE DISK

The I. O. Silver disk is a normal DOS 3.3 disk. You can boot it, catalog it and look at its programs to your prying heart's content. After you have played I. O. Silver, however, DOS 3.3 will necessarily be rendered inoperable (Brad had to murder DOS to make the game fit in 48K). The only thing resembling a DOS command that will work is "PR#6", which will reboot the disk.

If you want to Run any of the other programs on the disk, do a fresh boot on the I. O. Silver disk or any normal DOS 3.3 disk. To look at the I. O. Silver game code, you'll need to move DOS to the Language Card. (Beagle Bros' *PronotDOS* moves DOS 3.3.)

Sorry, we can't answer technical questions about how I. O. Silver was written, because we don't know. The author lives in Japan, and we'd give you his phone number, but (we've noticed) it's always 3 a.m. over there—tomorrow.

### I. O. SILVER SOURCE CODE AVAILABLE

If you are an advanced machine language programmer (or would like to become one some day) and you would like a copy of the source code for I. O. Silver, mail \$30.00 to Beagle Bros (address on back cover) along with the "Proof of Purchase" corner clipped from the back cover of this manual (important).

I. O. Silver was written with *Martin* (Roger Wagner Publishing) and should be compatible with most other assemblers. The code occupies a whopping three disks (both sides) and is fully commented. There is no printed matter included, but you can dump the code on your printer. Sorry, technical questions about the program or the source code can NOT be answered—you're on your own.

Rush—Software Order

BUSINESS REPLY MAIL

FIRST CLASS PERMIT NO. 200751 SAN DIEGO, CALIFORNIA

POSTAGE WILL BE PAID BY ADDRESSEE

BEAGLE BROS INC.

Attn: Minnie Assembler, Order Dept.  
3990 Old Town Ave., Suite 102C  
San Diego, California 92110

NO POSTAGE  
NECESSARY  
IF MAILED  
IN THE  
UNITED STATES



## Append

**TECHNICAL**  
The I. O. Silver  
and look at  
played I. O.  
inoperable (I  
only thing n  
will reboot t

If you wa  
boot on the  
I. O. Silver  
(Beagle Bros  
Sorry, we  
written, bec  
you his pho  
tomorrow.

**I. O. SILVER**  
If you are at  
become one  
I. O. Silver,  
the "Proof of  
(important).  
I. O. Silver  
should be c  
whopping t  
printed mat  
Sorry, techn  
be answer

Golly, more than  
anything, I hope that  
ALL Beagle Bros  
software purchasers  
mail me their  
Registration Cards...



Flo Chart, Beagle Bros Registration Desk