

For The Serious User Of Apple][Computers

COMPUTIST

Issue No. 41

March 1987

USA \$3.75
Canada/Mexico \$7.00
All Others \$13.25

Softkeys For:

The Periodic Table
Gemstone Warrior
Inferno
Frogger
Story Maker
Adventure Writer
Mummy's Curse

Feature:

**A two drive patch for
Winter Games**



Core:

**The games of 1986
in review**

(Page 20)

COMPUTIST
PO Box 110937-A
Tacoma, WA 98411

BULK RATE
U.S. Postage
PAID
Tacoma, WA
Permit No. 269

Coping With COMPUTIST

Welcome to COMPUTIST, a publication devoted to the serious user of Apple II and Apple II compatible computers. Our magazine contains information you are not likely to find in any of the other major journals dedicated to the Apple market.

New readers are advised to read this page carefully to avoid frustration when attempting to follow a softkey or when entering the programs printed in this issue.

■ What Is A Softkey Anyway? Softkey is a term which we coined to describe a procedure that removes, or at least circumvents, any copy-protection on a particular disk. Once a softkey procedure has been performed, the resulting disk can usually be copied by the use of Apple's COPYA program (on the DOS 3.3 System Master Disk).

■ Commands And Controls: In any article appearing in COMPUTIST, commands which a reader is required to perform are set apart by being in boldface and indented:

PR#6

The **RETURN** key must be pressed at the end of every such command unless otherwise specified.

Control characters are specially boxed:

6

Press **6**. Next, place one finger on **CTRL** and press **P**. Remember to enter this command line by pressing **RETURN**.

■ Requirements: COMPUTIST programs and softkeys require one of the Apple II series of computers and a disk drive with DOS 3.3. These and other special needs are listed at the beginning of the article under "Requirements".

■ Software Recommendations:

1) *Applesoft Program Editor* such as Global Program Line Editor (GPLLE).

2) *Sector Editor* such as DiskEdit (from the Book of Softkeys vol I) or ZAP from Bag of Tricks.

3) *Disk Search Utility* such as The Inspector, The CIA or The CORE Disk Searcher (from the Book of Softkeys vol III).

4) *Assembler* such as the S-C Assembler from S-C software or Merlin/Big Mac.

5) *Bit Copy Program* such as Copy II Plus, Locksmith or The Essential Data Duplicator

6) *Text Editor* (that produces normal sequential text files) such as Applewriter II, Magic Window II or Screenwriter II.

COPYA, FID and MUFFIN from the DOS 3.3 System Master Disk are also useful.

■ Super IOB: This powerful deprotection utility (COMPUTIST 32) and its various controllers are used in many softkeys. This utility is now available on each Super IOB Collection disk.

■ RESET Into The Monitor: Softkeys occasionally require the user to stop the execution of a copy-protected program and directly enter the Apple's system monitor. Check the following list to see what hardware you will need to obtain this ability.

Apple II Plus - Apple IIe - Apple compatibles: 1) Place an Integer BASIC ROM card in one of the Apple slots. 2) Use a non-maskable interrupt (NMI) card such as Replay or Wildcard.

Apple II Plus - Apple compatibles: 1) Install an F8 ROM with a modified RESET vector on the computer's motherboard as detailed in the "Modified ROM's" article (COMPUTIST 6 or Book Of Softkeys III) or the "Dual ROM's" article (COMPUTIST 19).

Apple IIe - Apple IIc: Install a modified CD ROM on the computer's motherboard. Cutting Edge Ent. (Box 43234 Ren Cen Station-HC; Detroit, MI 48243) sells a hardware device that will give you this important ability but it will void an Apple IIc warranty.

■ Recommended Literature: The Apple II Reference Manual and DOS 3.3 manual are musts for any serious Apple user. Other helpful books include: *Beneath Apple DOS*, Don Worth and Pieter Lechner, Quality Software; *Assembly Language For The Applesoft Programmer*, Roy Meyers and C.W. Finley, Addison Wesley; and *What's Where In The Apple*, William Lubert, Micro Ink.

■ Keying In Applesoft Programs: BASIC programs are printed in COMPUTIST in a format that is designed to minimize errors for readers who key in these programs. If you type:

```
10HOME:REMCLEAR SCREEN
```

The LIST will look like:

```
10 HOME ; REM CLEAR SCREEN
```

because Applesoft inserts spaces into a program listing before and after every command word or mathematical operator. These spaces usually don't pose a problem except in line numbers which contain REM or DATA commands. There are two types of spaces: those that have to be keyed and those that don't. Spaces that must be keyed in appear in COMPUTIST as delta characters (Δ). All other spaces are there for easier reading. NOTE: If you want your checksums (See "Computing Checksums" section) to match up, you must only key in (Δ) spaces after DATA statements.

■ Keying In Hexdumps: Machine language programs are printed in COMPUTIST as both source code and hexdumps. Hexdumps are the shortest and easiest format to type in. You must first enter the monitor:

```
CALL -151
```

Key in the hexdump exactly as it appears in the magazine, ignoring the four-digit checksum at the end of each line (a "\$" and four digits). A beep means you have typed something that the monitor didn't understand and must, therefore, retype that line.

When finished, return to BASIC with:

```
E003G
```

BSAVE the program with the correct filename, address and length parameters given in the article.

■ Keying In Source Code The source code is printed to help explain a program's operation. To key it in, you will need the S-C Assembler.

Without this assembler, you will have to translate pieces of the source code into something *your* assembler will understand. A table of S-C Assembler directives appears in COMPUTIST 17.

■ Computing Checksums Checksums are four-digit hexadecimal numbers which tell if you keyed a program exactly as it appears in COMPUTIST. There are two types of checksums: one created by the CHECKBIN program (for machine language programs) and the other created by the CHECKSOFT program (for BASIC programs). Both appeared in COMPUTIST 1 and The Best of Hardcore Computing. An update to CHECKSOFT appeared in COMPUTIST 18. If the published checksums do not match those created by your computer, then you typed the program incorrectly. The line where the first checksum differs has an error.

■ CHECKSOFT Instructions:

```
LOAD filename  
BRUNCHECKSOFT
```

Get the checksums with: **&RETURN** and correct the program where the checksums differ.

■ CHECKBIN Instructions:

```
CALL -151  
BLOAD program filename
```

Install CHECKBIN at an out of the way place

```
BRUN CHECKBIN,AS6000
```

Get the checksums by typing the starting address, a period and ending address of the file followed by a **YRETURN**.

```
xxx.xxx Y
```

Correct the lines at which the checksums differ.



You have a LEGAL RIGHT to an unlocked backup copy

Our editorial policy is that we do NOT condone software piracy, but we do believe that users are entitled to backup commercial disks they have purchased. In addition to the security of a backup disk, the removal of copy-protection gives the user the option of modifying programs to meet his or her needs.

Furthermore, the copyright laws guarantee your right to such a DEPROTECTED backup copy:

... "It is not an infringement for the owner of a copy of a computer program to make or authorize the making of another copy or adaptation of that computer program provided:

1) that such a new copy or adaptation is created as an essential step in the utilization of the computer program in conjunction with a machine and that it is used in no other manner, or

2) that such new copy or adaptation is for archival purposes only and that all archival copies are destroyed in the event that continued possession of the computer program should cease to be rightful.

Any exact copies prepared in accordance with the provisions of this section may be leased, sold, or otherwise transferred, along with the copy from which such copies were prepared, only as part of the lease, sale, or other transfer of all rights in the program. Adaptations so prepared may be transferred only with the authorization of the copyright owner."

United States Code title 17, §117 (17 USC 117)

You asked for it...

A Disk—Magazine Combo Subscription!

We now have a combination library disk & first-class subscription rate to save you even more. With this new 'COMBO' subscription, you will receive each monthly issue AND its corresponding disk for as much as 43% off the individual rate.

COMBO subscriptions are mailed First Class. AND, you can UPGRADE to this new offer.

OLD NEWS:

COMPUTIST's
annual
subscription
rate has

DROPPED.

Old Rates:

U.S. Domestic \$40 per year

U.S. First Class \$48 per year

Canada and Mexico \$68 per year

All other foreign \$120 per year

Yes I want to subscribe. Enclosed are U.S. Funds (drawn on a U.S. bank) for a 12 issue subscription.

New Subscriber Please renew my subscription

U.S. \$32 U.S. First Class/Canada/Mexico \$45 Other Foreign \$75

Combination magazine and corresponding disk subscriptions:

U.S./Canada/Mexico \$100 Other Foreign \$140

To upgrade your subscription to a combo subscription, U.S./Canada/Mexico send \$5.50 per remaining issue. Other Foreign send \$6.50 per remaining issue.

Name _____ ID# _____

Address _____

City _____ State _____ Zip _____

Country _____ Phone _____

  _____ Exp. _____

Signature _____ CP41

U.S. Funds drawn on U.S. bank. Subscription will not commence until funds are received. Send orders to: COMPUTIST PO Box 110846-T Tacoma, WA 98411

EXPIRED?

Keep your subscription ALIVE!

Check your mailing label to see if you need to renew your subscription. And if you think you might forget when the time arrives, renew right now. Just use this order blank. Remember, late renewals cannot be back dated.

if you're moving

Let us know at least 30 days in advance so that you won't miss a single issue. Just write your new address on the order form above, and your old address below (or include your present address label).

■ Issues missed due to non-receipt of Change-of-Address may be acquired at the regular back-issue rates. Please remember, the Post Office does not forward third class mail unless requested.

■ COMPUTIST is not responsible for replacing issues lost while forwarding order is in effect.

Name _____ ID# _____

Address _____

City _____ State _____ Zip _____

Country _____ Phone _____



Midwest Computer Camp

(317) 297-2700



Over 15,000 Alumni

- Robotics, graphics
- Introduction thru Assembly language
- Lasers

- 8 to 18 coed
- 1:1 computers/campers
- 1:4 counselor/campers
- 6 hrs/day on computer
- All popular computers
- All languages

Plus all traditional outdoor activities including swimming, archery, shooting, arts & crafts, team sports, wildlife, hiking, nature, astronomy and much more. For free brochure contact:

9392 Lafayette Road, Unit B6, Indianapolis, IN 46278

40¢ per disk?

And that INCLUDES the Tyvek sleeve, too?

SS/DD
5 1/4" for use with:

- Apple
- Commodore
- Atari
- Epson
- TRS-80

50 bulk disks for only \$20

- Sold only in sets of 50.
- 100% guaranteed.
- reinforced hubs.
- Tyvek sleeves & Write-protect tabs included.

Send your order to:
Disk Offer
SoftKey Publishing
PO Box 110846-T
Tacoma, WA 98411

Enclose \$4 shipping & handling for each set.

Domestic orders only, please include street address for UPS delivery.

Washington state orders add 7.8% sales tax.

Offer good while supplies last. Expires April 30, 1987.

Please send me _____ sets (50 disks per set) of 5 1/4" SS/DD diskettes. I have enclosed \$20 PLUS \$4 shipping & handling for each set and made checks / money orders payable to SoftKey Publishing.

Name _____ ID# _____
 Address _____
 City _____ State _____ Zip _____
 Country _____ Phone _____
 Exp. _____
 Signature _____

order BEFORE April 1 to

SAVE \$5

THE BOOK OF SOFTKEYS VOLUME III

Volume III contains these softkeys: Alien Addition | Alien Munchies | Alligator Mix | Computer Preparation SAT | Cut And Paste | Demolition Division | DLM (Development Learning Materials) software | EA (Electronic Arts) software | Einstein Compiler version 5.3 | Escape From Rungistan | Financial Cookbook | Flip Out | Hi-Res Computer Golf II | Knoware | Laf Pak | Last Gladiator | Learning With Leeper | Lion's Share | Master Type v1.7 | MatheMagic | Minus Mission | Millionaire | Music Construction Set | One On One | PFS software | PS (Penguin) Software | The Quest | Rocky's Boots | Sabotage | Seadragon | Sensible Speller IV | Snooper Troops II | SoftPorn Adventure | Stickybear series | Suicide | TellStar | Tic Tac Show | Time Is Money | Transylvania | Type Attack | Ultima III Exodus | Zoom Graphics | Breaking Locksmith 5.0 Fast Copy | Csave | The Core Disk Searcher | Modified ROMs | The Armonitor |

To order, send \$12.95 per copy plus shipping/handling per book (\$2: domestic \$5: foreign). US funds drawn on US bank. In Washington State add 7.8% sales tax. Send check/money order to:

COMPUTIST PO Box 110937-T Tacoma, WA 98411

THIS IS A SPECIAL PRE-PUBLICATION PRICE. Orders will be shipped approximately March 31, 1987. Special Offer expires April 1, 1987.

COMPUTIST

Issue 41

March 1987

Publisher/Editor: Charles R. Haight Managing Editor: Ray Darrah
Technical Editor: Robert Knowles Circulation: Debbie Holloway
Advertising: (206) 474-5750 Printing: Valco Graphics Inc., Seattle, WA

COMPUTIST is published monthly by SoftKey Publishing, 5233 S. Washington, Tacoma, WA 98409
Phone: (206) 474-5750

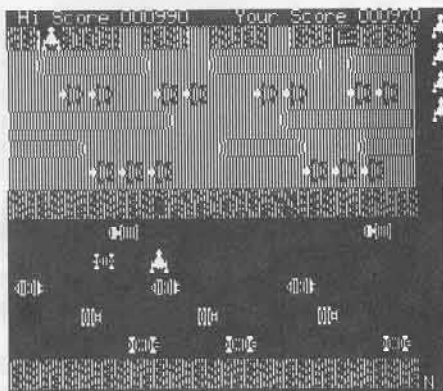
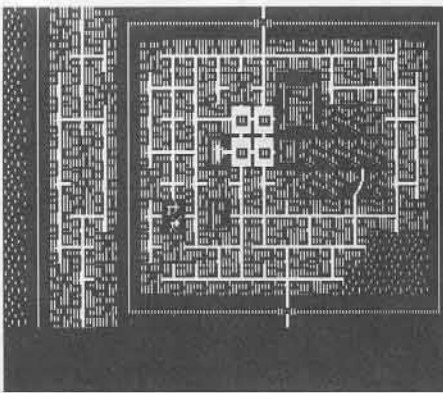

This month's cover:

Graphics from Strategic Simulations' "Rings of Zilfin."

Address all advertising inquiries to COMPUTIST, Advertising Department, PO Box 110816, Tacoma, WA 98411. Mail manuscripts or requests for Writer's Guides to COMPUTIST, PO Box 110846-K, Tacoma, WA 98411.

Unsolicited manuscripts are assumed to be submitted for publication at our standard rates of payment. SoftKey publishing purchases all and exclusive rights. For more information on submitting manuscripts, consult our writer's guide.

Entire contents copyright 1986 by SoftKey Publishing. All rights reserved. Copying done for other than personal or internal reference (without express written permission from the publisher) is prohibited.

The editorial staff assumes no liability or responsibility for the products advertised in the magazine. Any opinions expressed by the authors are not necessarily those of COMPUTIST magazine or SoftKey Publishing.

COMPUTIST will replace lost issues for 60 days following the publication date. We cannot be held responsible for mail loss beyond 60 days.

Apple usually refers to an Apple II computer and is a trademark of Apple Computers, Inc.

SUBSCRIPTIONS: Rates (for 12 issues): U.S. \$32, U.S. 1st Class, Canada & Mexico \$45, Foreign \$75. Direct inquiries to: COMPUTIST, Subscription Department, PO Box 110846-I, Tacoma, WA 98411.

DOMESTIC DEALER RATES: Call (206) 474-5750 for more information.

Change of Address: Please allow 4 weeks for change of address to take effect. On postal form 3576 supply your new address and your most recent address label. Issues missed due to non-receipt of change of address may be acquired at the regular back issue rate.

softkeys:

12 The Periodic Table

by Andrew Carr

14 Gemstone Warrior

by Red Williams

27 Inferno

by Charles S. Taylor

28 Frogger

by M. M. McFadden

features:

10 A two drive patch for Winter Games

Are you tired of always flipping the disk over with Winter Games? This article tells you how to beat Epyx at their own game. *by Robert Muir*

13 Customizing the speed of a Duodisk

This is an expansion of William Wingfield Jr.'s article which shows you how to easily and accurately adjust the speed of your duodisk. *by Andrew Carr*

16 Roll the presses part two: Printshop Printer Drivers

Do you have a printer not supported by Printshop? Or, maybe you just want to know more about the inner workings of this program. If so, this article is for you. *by Jerry Lewis*

core:

20 The games of 1986 in review

This month, we look at the first half of the adventure games of 1986. *by Jeff Hurlburt*

departments:

4 Input

7 Readers' Softkey & Copy Exchange

Scholastic's *Story Maker* by Edward Hauff, Codewriter's *Adventure Writer* by Jim S. Hart, Highlands' *Mummy's Curse* by Tim Snyder, Datasoft's *Zaxxon* by Marc Batchelor, *The Quest* by Gregory Moore, Activision's *Pitfall II* and *H.E.R.O.* by Jim S. Hart

Please address letters to:

COMPUTIST
Editorial Department
PO Box 110846-K
Tacoma, WA 98411

Include your name, address and phone number.

Correspondence appearing in the INPUT section may be edited for clarity and space requirements. In addition, because of the great number of letters that we receive and the small size of our staff, a response to each letter is not guaranteed.

Our technical staff is available for phone calls between 1:30 pm and 4:30 pm (PST) on Tuesdays and Thursdays only.

Opinions expressed are not necessarily those of COMPUTIST or SoftKey Publishing.

Cutting Edge Enterprises Announces Version 3.0 of its Senior PROM

Cutting Edge Enterprises, a Detroit-based producer of software and hardware products for the Apple // series of computers, announced the release of Version 3.0 of its utility, programming and deprotection aid the Senior PROM. The Senior PROM is a set of utilities in ROM that are undetectable by any program, yet instantly available for examining memory disks, and for writing and debugging programs. Since the Senior PROM is in ROM, it is always available without having to load it from diskette first.

The new release of the Senior PROM is easier to use, with consistent methods of movement between features within the Senior PROM. Other new features include an improved Sector Editor that provides a visual indication of exactly what byte is being edited, new memory/disk search and find features that are more efficient and user-friendly, a screen-to-printer function that is available from any point in the Sector Editor, a new laminated keyboard function strip and new documentation reflecting all version 3.0 changes.

Other features the Senior PROM has maintained in the new release include the ability to enter the Monitor from any program, a complete Sector Editor with its own operating system, and a "Switcher" program that allows the user to keep two 64K programs in memory and switch between them in a matter of seconds. Also, the ability to interrupt a program, view, edit or modify it, and then restart it is featured. In addition, the program may be saved to a normal DOS disk and later restarted in another Apple computer. Also included are many Assembly language utilities such as an Assembler, Step and Trace functions, and disk copy and format utilities.

User support and orders are available at 317-743-4041, or via modem at 313-349-2954 (300 and 1200 baud, 24 hours a day). Also, Cutting Edge Enterprises is continuing to provide a low profile Senior PROM for users with long peripheral cards in slot six or seven. The Senior PROM is available for the Apple //e and //c, and can be obtained from Cutting Edge Enterprises (43234 Ren Cen Station, Detroit, MI 48243) for \$79.95. Purchasers of earlier versions can upgrade to the new release for the nominal fee of \$10.00.

Mr. Clay Harrell
Cutting Edge Enterprises
43234 Ren Cen Station
Detroit, MI 48243

Senior PROM Rebuttal

After reading your review of the Senior PROM in COMPUTIST No. 35, I have a couple of important comments to make as a Senior PROM owner.

The first is in regards to "ease of use". When I first purchased my Senior PROM about a year ago, I knew very little about Assembly language (or anything else for that matter) on the Apple. I found the Senior PROM very useful and easy to use without knowing Assembly language. About two months after purchasing the Senior PROM, the latest version (2.0) became available and I upgraded for a very reasonable \$10. I found this version offered many more enhancements, and was even easier to use. With it, I have been able to backup most of my software library without having to know Assembly language.

In your review, you failed to mention many useful deprotection features of the Senior PROM. Aside from the regular features, one "feature" the Senior PROM has provided me is incentive. Since purchasing the Senior

PROM, I have found it gave me incentive to explore my Apple and learn more about it. In the last two months I have started to learn Assembly language, and I have officially cracked my first program unassisted (opposed to using the push button Senior PROM backup)! I feel the Senior PROM was the incentive that got me started. It made digging into my Apple //e much easier, and provided me with the tools I needed to start learning. Now that I'm an "experienced" Apple user, I still find the Senior PROM extremely useful and educational.

In your review you failed to mention the NMI deprotection features of the Senior PROM. One such feature I use a lot is the disassemble at the program's running address. I find this feature extremely useful to find exactly where in memory a program is running at any moment. Also the ability to disassembly volatile memory (such as text page 1) is very useful.

Finally, I noticed in your review was regarding the height of the Senior PROM. Shortly after purchasing the Senior PROM, I bought a Cider Hard Disk for my Apple. Upon installation of the Cider controller card in slot 7, I found the Senior PROM interfered with the long Cider card. After contacting Cutting Edge Enterprises about this, they instructed me to return my Senior PROM for a "low profile" version (along with \$10.00). In less than a week I received my new Low Profile Senior PROM, which no longer interfered with my long Cider card in slot 7.

In closing, I have found the Senior PROM to be extremely useful and easy to use. Also, Cutting Edge Enterprises has been a very personal company, which has provided me with great support, and inexpensive products and upgrades.

Sean Barger
Boonton, NJ

Mr Barger: Please see our update on the Senior PROM appearing on page 14 of this magazine.

Enhancing Infocom Text Reader

I found the article by George and John Bigelow of great interest and offer the enclosed additions to their program. The additions consist of two parts.

Part one is line 155 and lines 620-830. These lines expand the known abbreviations before printing a line on the Printer (the screen format is unchanged). The price you pay for the expanded output is a much slower printing time

input

(28 seconds for the original, and approximately 180 seconds for the modified version).

Part two consists of line 840 on. These lines contain the actual abbreviations, found as explained in the article (sorry that I can't give you a quick way of finding them). Line 850 tells the program how many abbreviations follow.

The effect of this patch is that two lines from Hitchhiker that look like:

```
M?YUCCHHH@0;<=<JJERKED;<F<BSENSES;BY;<;R  
EALISATI=I<C<<JLICKING;<;LINING;<DA;WHA
```

become:

```
M?YUCCHHH!;YOU ARE JERKED TO YOUR SENSE  
S BY THE REALIZATION THAT YOU ARE LICKIN  
G THE LINING OF A WHA
```

which makes much more sense.

Keep up the good work.

Part One

```
155 READ N : DIM AS(N) , BS(N) : FOR I = 1 TO N  
  : READ AS(I) , BS(I) : NEXT : REM  
  : READ ABBREVIATIONS  
620 IF AS <> "Y" AND AS <> "y" AND AS <> "N"  
  AND AS <> "n" THEN VTAB 22 : PRINT : GOTO  
  610  
630 VTAB 22 : PRINT : VTAB 24 : PRINT  
  "WORKING..."  
  " : VTAB 1 : REM 17 SPACES  
640 PR# 1 : PRINT CHR$(9) "80N" : REM  
  : DISABLE VIDEO ECHO  
650 FOR Y = 2 TO 22  
660 FOR X = 1 TO 40  
670 VTAB Y : HTAB X  
680 XY = SCR(N * (X - 1) * 2 * (Y - 1) ) + 16 *  
  SCR(N * (X - 1) * 2 * (Y - 1) + 1)  
690 BS = BS + CHR$(XY - 128)  
700 NEXT X  
710 FOR I = 1 TO LEN(BS) : DS = MID$(BS , I , 2)  
  : K = 0  
720 IF PEEK(-16368) > 128 THEN CS = "" : BS =  
  "" : POKE - 16368 , 0 : GOTO 800  
730 IF LEFT$(DS , 1) > "@" THEN DS = LEFT$(DS  
  , 1) : GOTO 760  
740 FOR J = 1 TO N : IF DS = AS(J) THEN K = J : J  
  = N : I = I + 1  
750 NEXT J : DS = LEFT$(DS , 1) : IF K <> 0  
  THEN DS = BS(K) + ""  
760 CS = CS + DS : NEXT I  
770 VTAB 1 : HTAB 1 : PRINT CS  
780 IF AS = "Y" OR AS = "y" THEN PRINT  
790 BS = "" : CS = "" : NEXT  
800 VTAB 1 : PRINT  
810 PR# 0  
820 VTAB 24 : HTAB 1 : PRINT "PRESS^A^ KEY^  
  TO^ CONTINUE-" : GET AS  
830 GOTO 170
```

Infocom Text Reader Modification Part Two

(Abbreviations for Hitchhiker given)

```
840 REM ABBREVIATIONS FOR HITCHHIKER  
850 DATA 113 : REM  
  : NUMBER OF ABBREVIATIONS KNOWN  
860 DATA "<:" , "THE" , "<<" , " " , "<=" ,  
  "YOU" , "<>" , "YOU" , "<?" , "AND"  
870 DATA "<@" , "?THE" , "<A" , " " , "<B"  
  "YOUR" , "<C" , "THAT" , "<D" , "OF"  
880 DATA "<E" , "IS" , "<F" , "TO" , "<G"  
  "CAN'T" , "<H" , "WITH" , "<I" , "HAVE"  
890 DATA "<J" , "ARE" , "<K" , "FROM" , "<L"  
  "ABOUT" , "<M" , "IN" , "<N" , "FOR"  
900 DATA "<O" , "?THERE" , "<P" , "WHICH"  
  "<Q" , "ALREADY" , "<R" , "THIS" , "<S"  
  "SOMETHING"  
910 DATA "<T" , "?IT" , "<U" , "THROUGH"  
  "<V" , "?THIS" , "<W" , "NOTHING" , "<X"  
  "?PROSSER"  
920 DATA "<Y" , "?IT'S" , "<Z" , "?FORD"  
  " " , "DON'T" , "=<" , "?ARTHUR" , "=="  
  "?THERE'S"  
930 DATA ">" , "AROUND" , "=?" , "?YOU'RE"  
  "=@" , "?BEAST" , "=A" , "INTO" , "=B"  
  "LIKE"  
940 DATA "=C" , "IT" , "=D" , "DOESN'T" , "=E"  
  "?FOOTNOTE" , "=F" , "BUT" , "=G"  
  "YOU'RE"  
950 DATA "=H" , "SMALL" , "=I" , "ON" , "=J"  
  "WILL" , "=K" , "JUST" , "=L" , "BECAUSE"  
960 DATA "=M" , "SEE" , "=N" , "HAS" , "=O"  
  "NOT" , "=P" , "SEEMS" , "=Q" , "IT'S"  
970 DATA "=R" , "?IMPROBABILITY" , "=S"  
  "TOWARD" , "=T" , "YOU'VE" , "=U"  
  "WHAT" , "=V" , "SAYS"  
980 DATA "=W" , "AT" , "=X" , "HERE" , "=Y"  
  "VERY" , "=Z" , "LOOKS" , ">:" ,  
  "PROBABLY"  
990 DATA "><" , "YOU" , ">=" , "CAN" , ">>" ,  
  "ALL" , ">?" , "OUT" , ">@" , "ANYTHING"  
1000 DATA ">A" , "THINK" , ">B" , "CLOSED"  
  ">C" , "ISN'T" , ">D" , "HIS" , ">E"  
  "?I"  
1010 DATA ">F" , "DOWN" , ">G" , "WOULD"  
  ">H" , "THEIR" , ">I" , "LARGE" , ">J"  
  "FRONT"  
1020 DATA ">K" , "?I'M" , ">L"  
  "?UNFORTUNATELY" , ">M" , "BE" , ">N"  
  "LITTLE" , ">O" , "?ARTHUR"  
1030 DATA ">P" , "EVEN" , ">Q" , "?HE" , ">R" , "  
  "SOME" , ">S" , "?FORD" , ">T" , "HOLDING"  
  "  
1040 DATA ">U" , "BETWEEN" , ">V"  
  "ANYTHING" , ">W" , "ACROSS" , ">X"  
  "GOING" , ">Y" , "CURRENT"  
1050 DATA ">Z" , "SOMETHING"  
1060 DATA "@M" , " " , "@O" , "!" , "@P" , "?"  
  "@S" , " " , "@W" , "-" , "@X" , ":" ,  
  "@Y" , " (" , "@Z" , ") )
```

```
1070 DATA "@D" , "1" , "@E" , "2" , "@F" , "3"  
  "@G" , "4" , "@H" , "5" , "@I" , "6"  
  "@J" , "7" , "@K" , "8" , "@L" , "9"
```

Infocom Text Reader Modification Part Two

(Abbreviations for Zork II given)

```
840 REM ABBREVIATIONS FOR ZORK II  
850 DATA 34 : REM  
  : NUMBER OF ABBREVIATIONS KNOWN  
860 DATA "<:" , "THE" , "<<" , "=THE" , "<=" ,  
  "=YOU" , "<>" , "AND" , "<?" , "=THERE"  
870 DATA "<@" , "IS" , "<A" , "YOU" , "<B"  
  "OF" , "<C" , "TO" , "<D" , "CAN'T"  
880 DATA "<E" , "WITH" , "<F" , "ARE" , "<G"  
  "=THIS" , "<H" , "YOUR" , "<I" , "FROM"  
890 DATA "<J" , "ROOM" , "<K" , "=WIZARD"  
  "<L" , "THAT" , "<M" , "IN" , "<N" , "WHICH"  
  "  
900 DATA "<O" , "HAVE" , "<P" , "LARGE" , "<Q"  
  "INTO" , "<R" , "SEEMS" , "<S" , "THIS"  
910 DATA "<T" , "SMALL" , "<U" , "BUT" , "<V"  
  "HERE" , "<W" , "APPEARS" , "<X"  
  "THROUGH"  
920 DATA "<Y" , "DRAGON" , "<Z" , "=IT" , ">S"  
  " " , ">M" , " "
```

Kevin Sartorelli
Parkdale, New Zealand

Karate Champ

First, let me congratulate you people on a great magazine. Second let me inform your readers on a way to back-up Karate Champ by Data East, which in my opinion is a HORRIBLE game and should not be purchased by the general public. My reason being if people don't buy a second or third rate program then it will force the software developer to produce not just better games but better programs in general. Don't get me wrong, I am not trying to be mean or anything, I'm just tired of seeing people get ripped off, and, for those few unfortunate souls who have this program, here is a simple procedure for backing it up. Copy the program with Copy II+'s sector copier changing parameter number 60 to 00, 5A to 00 and 5B to 00. After copying, use the sector editor, being sure to patch the DOS by pushing the P button. Now read track 0, sector 5 changing byte 0A to 18, and byte 0B to 60, disabling the nibble count. I am currently working on a way to crack this, and it will be in the mail soon.

Jamie Ortega
Austin, Texas

input

ProDOS on a Franklin & Mr. Do

Unlimited men on Mr. Do: Use your sector editor, search the whole disk for C6 BA 10, on mine it was at track 22, sector 3. Change it to 4C E0 1D. Great for practice on those higher levels, but be careful not to win too many extra men. When the side fills up the graphics go!

To run ANY ProDOS on a Franklin, using a sector editor, read track \$1, Sector \$9 address \$5B & \$5C. If they are D0 03 change to EA EA. If not, search for 69 0B D0 03 and change D0 03 to EA EA.

Gene Easley
Norwalk, CA

Halley Modification

In COMPUTIST No. 28 there is a softkey for the Halley Project by Mindscape. It does not work. But with slight modification to the controller it will work perfectly. All I did is modify it so it would disable DOS's error checking at \$B942. Here is my softkey.

Mindscape Inc.
3444 Dundee Rd
Northbrook, IL 60062

Requirements:

Super IOB
A Blank disk

Step by Step

- 1) Install the controller into Super IOB.
- 2) Copy side A.
- 3) Enjoy your deprotected version of the Halley Project.

controller

```
1000 REM HALLEY PROJECT CONTROLLER
1010 TK = 0 : LT = 35 : CD = WR : MB = 151
1011 POKE 47426 , 24 : GOSUB 490 : GOSUB 610 :
    IF TK = 0 THEN GOSUB 310
1012 POKE 47426 , 52 : GOSUB 490 : GOSUB 610 :
    IF PEEK (TRK) = LT THEN 1050
1020 ST = 0 : T1 = TK : GOSUB 490 : RESTORE :
    GOSUB 190 : GOSUB 210 : GOSUB 170
1030 GOSUB 430 : GOSUB 100 : ST = ST + 1 : IF ST
    < 16 THEN 1030
1040 IF BF THEN 1060
1050 ST = 0 : TK = TK + 1 : IF TK < LT THEN 1030
```

```
1060 GOSUB 310 : GOSUB 230 : TK = T1 : ST = 0 : GOSUB
    490
1070 GOSUB 430 : GOSUB 100 : ST = ST + 1 : IF ST <
    16 THEN 1070
1080 ST = 0 : TK = TK + 1 : IF BF = 0 AND TK < LT THEN
    1070
1090 IF TK < LT THEN 1020
1100 HOME : A$ = "ALL ^ DONE" : GOSUB 450 : END
5000 DATA 213 , 170 , 150 , 213 , 170 , 173 , 255 , 255
    , 255 , 255
5010 DATA 1 ^ CHANGES
5020 DATA 17 , 0 , 154 , 29
```

Note: It will copy to track 7 then restart. It takes a long time for the copy process.

Jason Rosenwald
San Bernadino, CA

Sunburst's Science Series

I have found several useful softkey articles in your magazine. I am in education and as many readers state: "students rarely can share one program without damaging it just as they damage textbooks." Textbooks can still be used with torn covers and missing pages. Software obviously can not take the abuse textbooks can and still be useful. A textbook should have a useful life of three to five years. Most of the time software does not make it through one year.

The administrators and other supervisors don't think of software as they do textbooks. I can very easily request a class set of 30-50 texts and have no problems with getting them. If I were to do the same with a piece of software, everyone of my supervisors would disapprove it. They, for the most part, place software with films and records where only one copy is needed per school. After all, software programs are not intended to teach, but rather be used as enrichment.

Textbooks because of today's budget procedures are much easier to replace and purchase than software. This makes it very important to have a backup copy of the software used in classrooms.

Here is a softkey for 1985 programs for Sunburst's science series such as The Incredible Laboratory.

1) Boot the original disk until the main menu appears. Drop into the monitor by your favorite means.

2) Move The Incredible Laboratory RWTS to a safe place.

1900<B800.BFFFM

3) Insert a slave disk and reboot.

C600G

4) Save the RWTS to your Super IOB disk.

BSAVE

RWTS.Laboratory,A\$1900,L800

5) Install the Swap Controller (COMPUTIST No.22) into Super IOB and set it to load "RWTS.Laboratory,A\$1900" in line 10010 and copy the master disk. The same RWTS routine can be used for all programs through 1985. The 1986 programs can not be copied with the Swap Controller.

6) Catalog the copy from Swap Controller and determine what the "Hello" program is. If you can't decide go through the menu typing RUN for each file until it loads. If the disk hangs while you are doing this simply load a normal disk and catalog again. The Incredible Laboratory was easy the "Hello" program was called "Logo" but it isn't for some of the others in this series.

7) Use the System Master disk and BRUN MASTER CREATE. Use the name from the "Hello" program in step 6 as your new "Hello" and follow the prompts. The "Hello" for The Incredible Laboratory is "Logo".

That's all there is to it. You can now use COPYA or Super IOB Fast Copy to copy the softkeyed disk. No more worry about students using the master for a book marker or whatever else.

One publisher recently replaced one of our damaged disks for no charge but we did have to wait five weeks for it. So if you don't mind the wait, some publishers are sympathetic.

Thanks for a great magazine.

Wynn Pickelsimer
Casselberry, Florida

readers' softkey & copy exchange

Edward Hauff's softkey for...

Story Maker (64K & 128K)

Scholastic, Inc.

Requirements:

Apple II or clone
COPYA
Sector Editor
2 blank disks
Story Maker 64K or 128K

Story Maker seems to be, in my opinion, a poor attempt at producing a program to be equal to Story Machine by Spinnaker. Even though I don't like this particular program, I was asked to try to make a COPYA version for a friend who is an unfortunate owner. Upon booting, I found that this program is in ProDOS and I wasn't too sure how to go about cracking it because my knowledge of ProDOS is quite limited. I did know that Apple retained the same sector format for ProDOS that they used for DOS 3.3. After examination of the disk with a nibble viewer utility (I used DiskView from Hardcore Computing #2, I found that only the epilog bytes in the address and data fields had been altered from standard format. With this in mind, I knew COPYA could copy the disk if it was modified to ignore errors, but now the boot would no read the disk at it would be looking for the changed epilog marks which had been fixed to standard format by the modified COPYA. The next step was to compare the ProDOS 1.0.1 to the ProDOS 1.0.1 on my User's Disk. To my surprise, when I compared track 0, sector 0, there were only four bytes which were different, and other sectors I checked matched my User's Disk perfectly. I immediately made the four modifications to sector 0 and found that I had a functional COPYA version of Story Maker.

Here it is in cookbook form. This method will work for both the 64K and 128K versions of Story Maker.

- 1) INITIALize both sides of a blank disk.
- 2) RUN COPYA and break out of it with .
- 3) Delete line 70 to avoid formatting the disk and modify DOS to ignore errors (the decimal version of B942:18).

```
70  
POKE 47426,24  
RUN
```
- 4) Copy both sides of Story Maker.
- 5) Now either copy track 0, sector 0 of a ProDOS disk, or just make the following four sector edits to the program side of the copied

Story Maker.

Track 0	Sector 0:	
Byte	From	To
\$00	\$04	\$01
\$01	\$18	\$38
\$05	\$00	\$32
\$06	\$0B	\$A1

Be sure to write the sector back out. No modifications are needed for the picture disk. Have fun.

Jim S. Hart's softkey for...

Adventure Writer

Codewriter Corporation

Requirements:

Adventure Writer original
A blank disk
A fast DOS (optional)
A file copy program
A dislike for copy protection

Adventure Writer is a program that allows you to compose your own adventure games (hence the name). I am an adventure game nut, with the Ultima series being my favorite, so when I bought Adventure Writer, I went about seeing what the program could do. I was not disappointed with it except that it was copy protected. Since I dislike copy protection except for the fact that it was teaching me assembly language, I went about relieving that one problem. The cookbook instructions are at the end of the softkey, but if you are interested on how the protection was circumvented, read on...

The first thing I checked out was to see where data might be stored on the disk. Using EDD's "Analyze Original Disk" function showed that there was no data on track \$23 and that whole tracks were probably being used. The next thing to check was that the disk's formatting was normal. A random sampling of tracks with Copy II Plus' nibble editor revealed that the disk was written in a normal format. Since the format was normal I took a chance that the disk could be CATALOGed. Sure enough, I was right.

I then used Locksmith's fast copy program to make a test copy to work with. All was fine until the copier reached track \$04, sectors 0-1. It showed these sectors as not being normal while the rest of the disk was. Hmm... could it be that these two sectors had something to do with the copy protection? Ignoring this for

the moment, I tried booting up the copied disk. All seemed okay and it arrived at the main menu all right. Each menu item chosen worked fine with the exception of the "Run Adventure Writer" option.

After choosing this option, the disk drive came on, did some disk activity, and then printed garbage on the text screen and died. "Aha...", I thought, "those two sectors must have been important." I then followed the boot process in regard to what files were run in what order so that the guilty file could be found. The boot program, "AW", BLOADs "AW.OBJ" and the displays the menu. If the "Run Adventure Writer" option is chosen, a CALL 24576 is executed, which does a MAXFILES 1 then BLOADs the binary files "DBASE", "TABLE", "EDITOR", and "INTERPRETER" (look at an ASCII dump of the file "AW.OBJ" to see how I found these file names). The next thing it does is call a subroutine at \$4001. This is where the "DBASE" file was BLOADed in. At \$4001 there is a JUMP to \$454C. Success! Looking around \$454C you notice references to memory locations \$C0E8-\$C0EF (direct use of the disk drive in slot 6). This must be where the protection is lurking around.

After some inspection, I determined that the protection code starts at address \$457B and lingers on for about 30 bytes or so. Should I take out the call to the routine or satisfy it so that it thinks that everything was okay? The second option was the one I chose. At \$4584, the code checks to see if what was read from those two odd sectors matches a table loaded at \$4641. If the result checks out (result = zero) then everything is okay and the program proceeds. Well, I figured that the easiest way to fix this was to make sure that every byte matched up and gave a result of zero. I replaced the comparison instruction at \$4584 (CMP \$4641,X) with a Load Accumulator with zero (LDA #0) instruction followed by a NOP. The code will now think that every comparison was equal and go about its merry way. The protection scheme is history!

Step by Step

- 1) INITIALize the blank disk, preferably with a fast DOS. Use the file name "AW".
- 2) Copy the files from the original disk to the newly INITIALized disk.
- 3) Load up DOS and get into BASIC.
- 4) Put in the copy disk and load in the file with the protection in it:

```
BLOAD DBASE, AS4000
```
- 5) Enter the monitor via CALL -151.
- 6) Replace the CMP instruction with LDA #0 followed by a NOP.

4584:A9 00 EA

readers' softkey & copy exchange

7) Save the file back to the disk:

BSAVE DBASE, A\$4000, L\$64A

That's it! You now have a deprotected copy of Adventure Writer. I hope the techniques I used can help out other folks who are trying to deprotect their originals also.



Tim Snyder's softkey for...

Mummy's Curse

Highlands Computers, Inc.
14422 S.E. 132nd
Renton, WA 98056

Requirements:

- 48K
- Super IOB
- Swap Controller
- A blank disk
- A 48K slave disk with no hello program

Mummy's Curse is a hi-res adventure with color graphics. The object of the adventure is to find the solid gold burial mask and return it to the starting point. This process involves finding and using three amulets, some woodwork, and waving of a scepter. Mummy's Curse will hold your interest because of its save game feature. It is suitable for the beginning to intermediate adventurer.

Mummy's Curse is easily deprotected with the use of Super IOB and its swap controller.

The Deprotection:

1) INITIALize a blank disk with a normal or fast DOS using the filename "MUMMY."

INIT MUMMY

2) Boot the original Mummy's Curse disk and let the program load until you see the Applesoft prompt. At this point hit **ESC** and hold it.

While holding **ESC** you will see a series of three SYNTAX ERROR messages followed by FILE NOT FOUND. You will get the Applesoft prompt here.

3) Now type

CATALOG

You may get a SYNTAX ERROR the first time due to some leftover **ESC**s.

4) Enter the monitor and move the protected RWTS to a safe place:

CALL -151
1900<B800.BFFFM

5) Insert your slave disk with no hello program and reboot by typing

C600G

6) At the Applesoft prompt, save the RWTS either to the slave disk or a Super IOB disk with your Swap controller.

BSAVE MUM.RWTS,A\$1900,L\$800

7) Install the Swap controller into Super IOB and change line 10010.

**10010 PRINT CHR\$(4) "BLOAD
MUM.RWTS,A\$1900"**

(Make sure the RWTS is on the same disk with Super IOB). I usually have a copy of Super IOB with the Swap controller already installed handy. Then all I have to do is change line 10010 to load in the foreign RWTS.

8) Run Super IOB and copy tracks \$3-\$22 to the disk you INITIALized in step 11 (make sure the controller is set to start at track \$3 in order to skip the DOS image).

9) Boot DOS 3.3 again and create a new boot program for the copied version of Mummy's Curse.

FP
**10 PRINT CHR\$(4) "EXEC HELLO"
SAVE MUMMY**

(Save it to your new COPYA version of Mummy's Curse). The Mummy's Curse is now completely deprotected and is COPYAable.



Marc Batchelor's softkey for...

Zaxxon

Requirements:

- Apple II series or clone
- COPYA from DOS 3.3 System Master
- A sector editor
- A blank disk

When I recieved Zaxxon as a birthday present, I thought, "Great, I know that I can back it up if I just refer to all my back issues of (Hardcore) COMPUTIST." I then realized that I didn't have issue No. 7 in which the original softkey appeared, but I did have issue No. 10 in which a correction for the softkey was presented. While No. 10 did have all the sector edits, it did not provide how to first make a DOS-format copy.

No problem, I just flipped through to issue No. 17, and found a Super IOB controller for Zaxxon. I then loaded in Super IOB, typed in the controller, and ran the program without a

hitch. The moral: never throw away your old issues of COMPUTIST.

However, there was one slight drawback. The disk wouldn't boot. So, I loaded up my trusty old sector editor and read in track 0 sector 4 (altered in earlier Zaxxon softkeys). I felt pretty certain that this sector was not the problem, so I looked at track 0 sector 7 (another key sector). This is where the nibble count was supposed to be located. Unfortunately, it seemed that it was in a different place, as the disk wouldn't boot. So, I tried a different approach. I booted my DOS 3.3 system master and ran COPYA. I broke out of the program and typed

**70 POKE 770, 24 : POKE 863, 24 :
POKE 47426, 24**

and ran the program again. It copied without a hitch. I then booted up my trusty old sector editor and read in track 0, sector 4 again. I went to byte \$4F of that sector and told the program to look for a marker of \$DE instead of \$CC on the disk, and wrote it back out.

Next I disassembled track 0 sector 7 and found an instruction to read a byte off the disk (LDA \$C08C,X). I followed the logic all the way down to byte \$78, where there was a JuMP to \$019A (the stack area!) followed by a RTS. I figured that this must be the place for the nibble count, so I tried the Brute Force method. For the benefit of those readers who don't know, it is really quite simple. It consists of replacing the nibble count routine completely with No-Operation (\$EA or NOP) instructions, sort of like disabling a line of BASIC with a REM. What this method lacks in finesse, it makes up for in effectiveness. So, I started from byte \$22, and I NOPed the locations up to and including byte \$77. I then booted up my copy and it worked perfectly.

All Together Now...

1) RUN COPYA from the DOS 3.3 System Master and break out with **ESC**.

2) Replace line 70 with

**70 POKE 770,24: POKE 863,24:
POKE 47426,24**

and restart the program with RUN.

3) Boot up your sector editor and make the following changes:

Track	Sector	Byte	From	To
0	4	\$4F	\$CC	\$DE
0	7	\$22-\$77	...	all \$EA

Write the sectors back to the disk, and enjoy. If your Zaxxon is different, and none of the softkeys in past issues have helped, read in track 0 sector 7 and look for the pattern BD 8C C0 (LDA \$C08C,X). From there change everything to \$EA until you find a JuMP instruction. That should work.



readers' softkey & copy exchange

Gregory Moore's softkey for...

The Quest

Requirements:

COPYA
Sector Editor

For some reason, I found the softkey in COMPUTIST No. 13 would not work for my disk. Also, while Super IOB controllers are very useful, I find that using a modified COPYA is frequently just as effective.

A brief disk investigation with a nibble editor showed that the address and data epilogues were altered from the usual DE AA to DA AA. Also, on every other track, the address header had been altered from D5 AA 96 to D4 AA 96.

Here are the steps I used to unlock The Quest.

- 1) Start up the COPYA program.

RUN COPYA

- 2) After the disk stops spinning, hit  to halt the program. Next, remove line 70 so COPYA won't re-load COPY.OBJ.

70

- 3) Enter the monitor.

CALL -151

- 4) Make the following changes to DOS

B954:29 00
B993:00
B925:18 60

The first modification makes DOS ignore the first byte of the address header. The second one makes DOS ignore the first byte of the address epilogue and the last one tells DOS to ignore the data epilogue.

- 5) Re-enter BASIC and start up the COPYA program.



RUN

- 6) After COPYA is finished, make the following changes to the copied disk with a sector editor:

Track	Sector	Byte	From	To
\$00	\$03	\$35	\$DA	\$DE
\$00	\$03	\$91	\$DA	\$DE
\$00	\$03	\$54	\$4A	\$C9
\$00	\$03	\$55	\$49	\$D5
\$00	\$03	\$56	\$6A	\$D0
\$00	\$03	\$57	\$D0	\$F0
\$00	\$03	\$58	\$EF	\$EA

- 7) Copy the back side with any copier. It is not protected.

Lastly, here is a list of some of the changes you can make to DOS and COPY.OBJ to make COPYA perform miracles.

ADDRESS HEADER:
ignore first byte B954:29 00
ignore second byte B95E:29 00
ignore last byte B969:29 00

ADDRESS EPILOGUE:
ignore first byte B993:00
ignore second byte B99D:00
ignore both bytes B988:18 60

ADDRESS CHECKSUM:
ignore B98A:00

DATA HEADER:
ignore first byte B8E9:00
ignore second byte B8F3:00
ignore last byte B8FE:00

DATA EPILOGUE:
ignore B925:18 60

ERRORS:
ignore DOS read B942:18
ignore read/write B7C0:18
ignore RWTS BE48:18

COPY.OBJ
ignore read errors 3A1:EA
copy to track x 302:x+1 N 35F:x+1

Jim S. Hart's softkey for...

Pitfall II and H.E.R.O.

Requirements:

Pitfall II and/or H.E.R.O.
A blank disk
Super IOB v1.5

A friend of mine let me borrow his Mockingboard and some software of his recently so I could enjoy the enhanced audio effects the board provides. In return, however, I had to deprotect his Pitfall II and H.E.R.O. (both by Activision). "Fair enough," I thought. Using a nibble editor called DiskView I discovered that both disks had altered prologues and epilogues in both the address and data fields. Whipping out Super IOB, I made the necessary changes and then ran it.

Surprise, surprise! Track \$00 has some normal and some altered sectors. After trying to read each sector in the track, I found out which ones were normal and which were altered. This info was incorporated back into the Super IOB controller and it now worked like a champ. To deprotect either disk, insert the controller below into Super IOB v1.5, RUN it

and format the backup when it asks. That's all you have to do to deprotect these disks. Their RWTS is able to check for either normal or altered format and then read the disk using that format. Hide the original now and enjoy the game!

Step by Step

- 1) Insert the controller into Super IOB v1.5 and then RUN it.
- 2) Choose the "Format Backup" when asked.
- 3) When the program is finished, your copy will be in a COPYAable format.
- 4) If you have Bag of Tricks (Quality Software), reskew the disk with a "6 descending" value to speed up loading the game.
- 5) Enjoy

controller

```

1000 REM PITFALL II & H.E.R.O
1010 TK = 0 : ST = 0 : LT = 1 : CD = WR
1020 T1 = TK : GOSUB 490
1030 GOSUB 430 : IF (ST > 0 AND ST < 4) OR (ST
> 11 AND ST < 15) THEN RESTORE : GOSUB
170 : GOSUB 190 : GOSUB 210 : GOTO 1040
1035 GOSUB 230
1040 GOSUB 100 : ST = ST + 1 : IF ST < DOS THEN
1030
1050 IF BF THEN 1070
1060 ST = 0 : TK = TK + 1 : IF TK < LT THEN 1030
1070 GOSUB 490 : TK = T1 : ST = 0 : GOSUB 230
1080 GOSUB 430 : GOSUB 100 : ST = ST + 1 : IF ST
< DOS THEN 1080
1090 ST = 0 : TK = TK + 1 : IF BF = 0 AND TK < LT
THEN 1080
1100 IF TK < LT THEN 1020
1110 TK = 1 : LT = 35 : ST = 15 : LS = 15 : CD = WR
:FAST = 1
1120 RESTORE : GOSUB 170 : GOSUB 190 : GOSUB
210 : GOSUB 490 : GOSUB 610
1130 GOSUB 230 : GOSUB 490 : GOSUB 610 : IF
PEEK (TRK) = LT THEN 1150
1140 TK = PEEK (TRK) : ST = PEEK (SCT) : GOTO
1120
1150 HOME : PRINT "COPYDONE" : END
5000 DATA 222, 171, 237, 170
5010 DATA 170, 213, 171
5020 DATA 170, 213, 235
    
```

controller checksums

1000	- \$356B	1090	- \$AF51
1010	- \$182A	1100	- \$2A86
1020	- \$23F6	1110	- \$A199
1030	- \$B042	1120	- \$AEA6
1035	- \$3809	1130	- \$A83D
1040	- \$62F8	1140	- \$35DA
1050	- \$033A	1150	- \$0F01
1060	- \$2845	5000	- \$7358
1070	- \$4715	5010	- \$B4DD
1080	- \$5D1F	5020	- \$7DCD

Winter

by Robert Muir

EPYX, Inc.
1043 Kiel Court
Sunnyvale, CA 94089

Requirements:

Two disk drives
Two sixteen pin DIP sockets
Small screwdriver (or IC puller)
Low wattage soldering iron & solder
SPST switch & some wire

Alternative:

A sector editor
Deprotected Winter Games

Let's say you have one of the best competitive arcade games around but your wrist

is so tired from flipping the *\$%& copy protected disk over and over that your performance at the joystick is seriously hindered. Or you have a duodisk and want to look at the boot without the analog card being in the way. Take heart, here are two solutions for the first problem and one for the second.

If all you want to do is modify Winter Games and you don't want to mess around with the hardware stuff skip to the second part of the article. However, if you are like me and enjoy adding bells and whistles to the inside of your Apple then read on.

The Hardware Modification

This removable modification to the disk drive controller card will allow you to install a switch to change the drive one to drive two (but not drive two to drive one). While playing Winter Games I thought of adding a switch to make the game think that drive two was drive one and

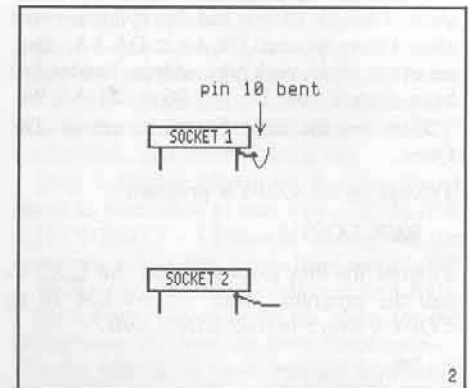

remembered Bruce Field's answer to a similar question in the Apple Doctor section of the June 85 issue of "Call - A.P.P.L.E.". He said to cut the traces going to pin 14 of drive one and drive two and connect them to a DPDT switch. I couldn't figure out how to do this on a duodisk so I tore into the game code (using Don Lancaster's excellent tearing method presented in "Enhancing Your Apple II") and came up with the small patch at the end of the article. Later I found the schematic for the controller card in Sather's "Understanding the Apple II" and figured out a better way for either disk II or duodisk controllers.

1) Get your empty DIP socket no.1 and bend pin 10 outward, (place the chip with its pins on the table with one end to the left, looking down at the holes count counter-clockwise from the lower left corner until you get to 10, see fig.1).

2) Turn off the computer, leave the computer plugged in and touch the power box to discharge static electricity. Pull out the controller card and find the chip labeled 74LS259 at location C2.

3) With the screwdriver or IC puller gently pry loose the chip being careful not to bend the pins. Plug DIP socket no.1 into the board socket, pins 1 & 16 to the left, (when the board is plugged in the left will be the front of the computer).

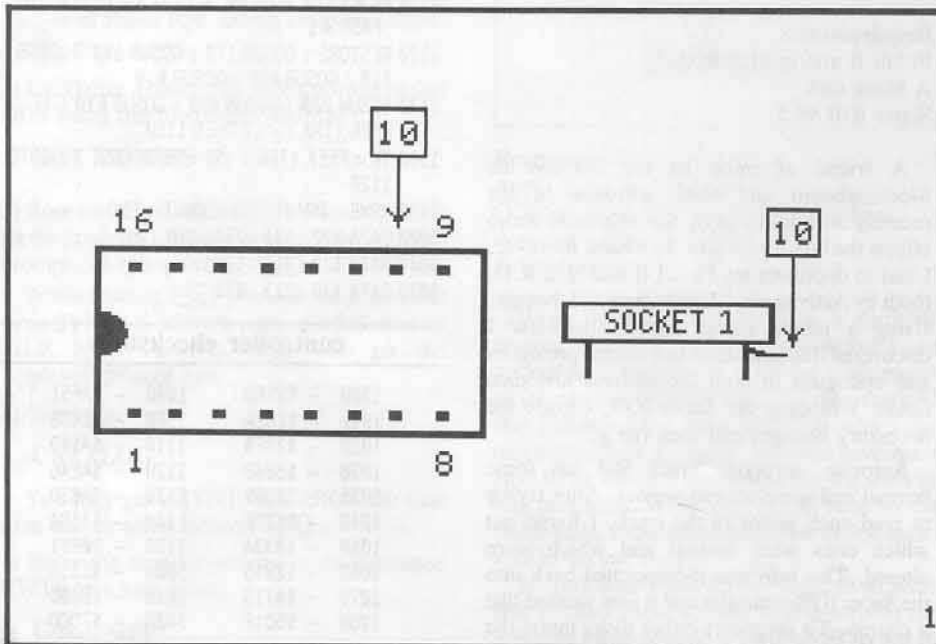

Games

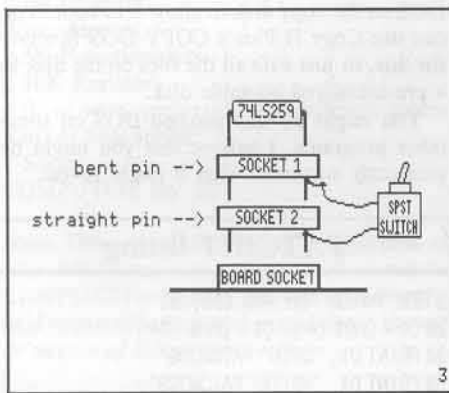

9) Finally insert the LS259 chip into the top socket. Plug the board in and we're finished. You can mount the switch anywhere you want. I drilled a hole in one of the plastic inserts in the back of the computer; this way I can remove everything and leave no trace.

The Software Modification

This modification to Winter Games adds a patch to the routine that asks you to flip the disk so that if it finds the wrong side in the current drive it will check the other drive.

Byte	From	To
\$B	\$20	\$EA
\$C	\$00	\$EA
\$D	\$BB	\$EA

2) Copy side two onto a blank disk and using a ZAP program make the following sector edits to both Track \$02, Sector \$0B of side 1 and Track \$02, Sector \$0E of side 2:

Change bytes \$82-\$99 to AA AD B1 B7 C9 01 D0 07 A9 02 8D B1 B7 D0 05 A9 01 8D B1 B7 68 4C 00 B7. That's it. No more flipping!

Now back to the old ski-jump.

4) Insert the LS259 into the modified socket, (make sure the little notch in the chip is facing the same way, (to the left), as all the others).

5) Do a test by plugging in the board and turning on the computer. Drive two should boot. If the test was not successful make sure you are counting the pins properly. When the socket is plugged into the board, pin #10 should be sticking out second from the upper-right.

6) Now turn off the computer, pull the board and retrieve our modified socket and solder one end of a wire to the bent-out pin. Solder the other end to one pin of the SPST switch.

7) Take the other empty 16-pin socket and carefully solder the end of the other wire to the base of pin #10 (see fig.2) (do not bend the pin). Be careful that the plastic does not melt, loosening the pin or that so much solder gets on the pin that the socket will not plug into another one. Solder the other end of the wire to the other pin of the switch.

8) Plug the unbent pin socket into the socket at C2. Pins 1&16 should be towards the left so the wire will be toward the top of the board second pin from the right. Plug the socket with the bent pin into the other socket with the same orientation.

1) Make an unprotected backup of Winter Games using Trevor Churchill's softkey in COMPUTIST No. 29. Change \$B942 to 18, copy disk with COPYA, edit Track \$00, Sector \$01:



The Periodic Table

by Doni G. Grande

COMPRESS
PO Box 102
Wentworth, NH 03282

Requirements:
COPYA

COMPRESS puts out a series of educational software that is really quite good. Its major fault is that most of their programs are copy protected. Backup disks may be purchased, but at a premium cost. Since most of their programs are meant to interact with students, it is essential to have several backups of each program. It is for this reason that the following softkey was devised. The Periodic Table is the program used as an example, but the procedure should work on other COMPRESS programs since many of COMPRESS's other programs use a similar protection scheme. What follows is the nuts and bolts description of how the protection used by COMPRESS was determined. If you want, just skip ahead to the step by step procedure.

Nuts and Bolts

If you use a nibble editor (such as that in Locksmith 6.0) to examine the original Periodic Table disk, you will discover that the address and data prolog marks are only slightly modified on the DOS tracks (0-2). The address field epilog marks are missing entirely, but the data field epilog is the standard DE AA. However, once you start looking at the rest of the disk, it is soon evident why nibble copiers have such a hard time with this disk. The data prolog marks are either D5 AA AD or D5 AA B5. The address marks appear to be just random data bytes, all following the form xx AA yy. An example is DD AA 9E found on track 8.

If you look at the rest of the disk, you soon discover that no two tracks have the same address marks! The COMPRESS DOS has to be able to make sense out of the disk data somehow, so there has to be some pattern to these strange address marks. The sequence DD AA 9E almost looks familiar. If you write this out in binary, it looks like:

DD AA 9E = 11011101 10101010 10011110

If you now AND the correct values of D5 AA 96 with these strange values, the pattern becomes:

```

DD AA 9E = 11011101 10101010 10011110
AND D5 AA 96 = 11010101 10101010 10010110
=====
D5 AA 96 = 11010101 10101010 10010110
    
```

Amazing, isn't it? When the protected tracks were written, the correct address marks of D5 and 96 were ORed with some (possibly random) value. Either COMPRESS DOS has an internal table of values to use or it simply ANDs each address epilog byte with the correct value while it is reading the disk. Our old friend DOS 3.3 can be taught the same trick, so we should be close to deprotecting The Periodic Table.

If you install a patch into DOS that ANDs the correct address bytes with the address bytes read from the disk, you will still find that something is not quite right. So you get out your trusty nibble editor and take another look at the disk. If you look at some of the tracks that are used for data (such as track \$12), you will occasionally notice a D5 in the sector data. This should make you sit up and take notice. D5 is reserved for address and data marks, and is never allowed in actual sector data! This means that COMPRESS' DOS uses a modified nibble translate table when reading the disk (see Beneath Apple DOS for more details about the normal use of the nibble translate table).

If you look at page \$BA in normal DOS you will find the normal read translate table located from BA96 through BAFF. The translated byte for D5 is located at \$BAD5 in normal DOS and is D5 (since it is not allowed, why translate it?). If you search for the read translate table in COMPRESS DOS you will find it on page \$BF. Looking at BFD5 reveals a value of 03, meaning that D5 is translated into 03 when read from the disk. This is the last key needed to deprotect The Periodic Table.

Step by Step

1) Type in the program below and save it on disk under the name PATCHIT. Now type RUN and the program will create a text file named PATCHDOS that contains all the commands necessary to patch normal DOS 3.3 so that it may read COMPRESS DOS disks.

2) EXEC PATCHDOS to make the patches to DOS.

3) You may now CATALOG The Periodic Table, RUN or LIST any of the programs on the disk, or use COPYA to copy the disk. If you do use COPYA, be sure to place a different DOS on the copy disk to allow it to boot. You can use Copy II Plus's COPY DOS function for this, or just FID all the files on the disk to a pre-initialized bootable disk.

You might try this patched DOS on some other programs. I believe that you might be pleasantly surprised what it might reveal.

PATCHIT listing

```

5 REM "PATCH FOR AND $D5, 96
10 D$ = CHR$ (4) : Q$ = CHR$ (34)
20 PRINT D$; "OPEN^ PATCHDOS"
30 PRINT D$; "WRITE^ PATCHDOS"
35 PRINT "MONCIO"
40 PRINT "CALL-151"
60 PRINT "B989:18^ 60" : REM "NO AF CSUM
70 PRINT "B74A:60" : REM "DISABLE INIT
80 PRINT "A56B:60" : REM "DISABLE INIT
85 REM "PATCH TO AND CORRECT VALUES W/1ST &
LAST AF HEADER
90 PRINT "B600:29^ D5^ C9^ D5^ 60^ 29^ 96^ C9^
96^ D0^ 03^ 4C^ 6D^ B9^ 4C^ 54^ B9"
100 PRINT "B954:20^ 00^ B6^ EA"
110 PRINT "B969:4C^ 05^ B6^ EA"
115 PRINT "B8FB:A9^ 00" : REM
"IGNORE DF HEADER 3
116 PRINT "BAD5:03"
120 PRINT "3D0G"
130 PRINT "?" : Q$; "PATCH^ INSTALLED" : Q$
135 PRINT "NONONCIO"
140 PRINT D$; "CLOSE"
    
```

checksums

5	- \$87C4	90	- \$4034
10	- \$42F8	100	- \$6591
20	- \$BD71	110	- \$B135
30	- \$0A7E	115	- \$5643
35	- \$B965	116	- \$58AA
40	- \$D713	120	- \$C1B0
60	- \$B7B2	130	- \$2D01
70	- \$785F	135	- \$819A
80	- \$F35F	140	- \$2C1B
85	- \$5CD8		



Duodisk

by Andrew Carr

Requirements:

- Drill & Bits
- Phillips Screw driver
- Soldering Iron, low wattage
- Wire strippers
- Wire snippers
- 2 5K Potentiometers
- 2 10K Resistors
- 4 ft. of wire, preferably two different colors
- 6 in. of heat-shrink
- 2 Knobs
- COMPUTIST No. 22

Note: This procedure involves modification of your disk drives which may void their warranty. COMPUTIST or SoftKey Publishing will not be held responsible for any damages due to the use or misuse of this article.

While reading William Wingfield's article on "Customizing Drive Speed Control" in COMPUTIST No. 22 page 15, I thought to myself this is a great idea for people who have single disk drives. Unfortunately I and a lot of other Apple users I know own a Duodisk drive, which leaves us with a great idea but no detailed instructions. While digging into my dilemma I found the job was still possible but more involved. As far as the electrical portion of the project goes it is still a simple matter of removing the 17K Ohm potentiometer, or "pot" for short, from the circuit board and replacing it with a 10K resistor & 5K pot, (K = 1000). The Disassembly & Reassembly of the Duodisk drive is where the help is needed.

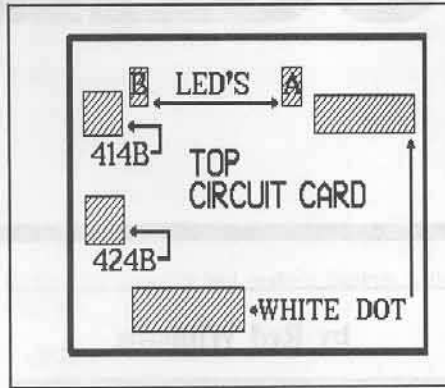
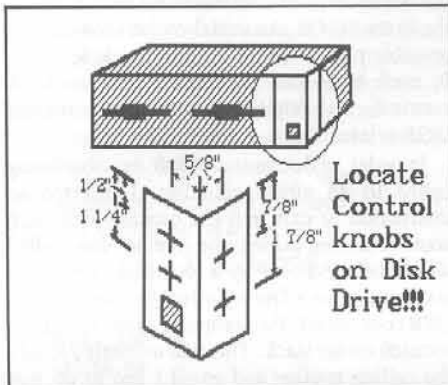

Modification instructions

- 1) Remove 2 screws on back & remove cover.
- 2) Remove 4 screws securing the top plates of the two drives, to remove plates pry up, push back, and lift back.
- 3) Mark & disconnect 4 connectors from top circuit card.
- 4) Either unplug the 2 LEDs from top circuit card or gently pull the LEDs away from front panel.
Note: Pulling the LED out of the front panel is quicker, easy & less chance of pinching wires in reassembly.
- 5) Remove 2 screws securing top circuit card and remove circuit card.
Note: Bowing case out helps removing circuit card.
- 6) Remove 2 screws securing plate beneath top circuit card and remove plate.
- 7) Remove 8 screws, lockwashers, and washers located on bottom of the Duodisk, securing the two diskdrives.
- 8) Remove each disk drive by pulling up and out.
- 9) Remove 4 screws on sides of each disk case.
- 10) Remove disk drive from case by pulling up and out.
Note: Bowing case out helps removing disk drive.
- 11) Remove 2 screws securing bottom circuit card and pull card away.
- 12) Locate 17K pot on left edge of circuit card.
- 13) Using low-heat solder iron remove 17K pot.

14) Attach 2 wire leads, 1 on each path to circuit card.

Note: Changing wire color to identify disk drive helps later.

15) Run leads though adjustment hole on bottom of disk drive case.

16) Repeat steps 9 - 15 for the other drive.

17) Reassemble in reverse order.

Notes: Bowing case helps in installing drives & circuit card. Watch for pinching wires. Connectors are not keyed, but top side of connectors are marked with a white dot or white numbers. Start screws before tightening

Mounting drive adjustment pot

Locate pot's in right corner of Front Panel either facing the front or the side. The knobs facing the side keeps the professional look of the system. Measure from bottom of DUODISK drive front panel 7/8 & 1 7/8 in., measure from right corner 3/4 in. for front or 1/2 in for side. Drill appropriate sized holes.

Connecting leads, Resistor, & Pot

Solder 10K Resistor to center terminal of 5K Pot. Connect one wire to resistor and the other to (back view) right terminal. Then solder leads in place, use Heat-shrink to cover any open metal.

In Closing

The drive speed modification is inexpensive, costing me about seven dollars at a Radio Shack, and very useful for bitcopying, saving time and frustration. As Luke Slytalker would say, this is one more weapon to use in the battle against the evil empire, Good Luck!

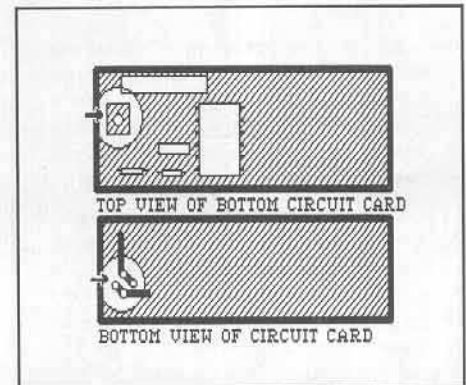

Senior PROM Update

by Robert Knowles

*The Senior Prom
Cutting Edge Enterprises
Box 43234 Ren Cen Station
Detroit, MI 48243
\$79.95*

When the Senior PROM was introduced last year (reviewed in COMPUTIST No. 35), it was a bargain then as it is now. Who wouldn't want having a sector editor, a copy card, a way to reset into the Monitor, DOS 3.3 utilities, and an enhanced Monitor with 'step and trace' capability, all in one neat (and inexpensive) package?

The latest version (3.0) of the Senior PROM (SP) offers some improvements over the 2.0 version, mostly at the user level. Among the changes are a reorganization of the key layout when in the Wait mode and more consistent and/or logical key usage between modes. Also provided is a plastic-laminated keyboard layout chart with the Wait Mode and Sector Editor commands listed on it for easier reference. The documentation remains at a decent quality level, and has been compressed into a thinner manual. Also included is documentation for a deprotection program called Advanced Demuffin, which appears on the utility disk.

The major changes are in the sector editor, which was a sore spot in version 2.0. It still has all the features that made it flexible in the previous version, but the most irritating bugs have been taken care of. The Editor now highlights the byte currently being changed and the screen print function is accessible from all parts of the sector editor. The memory/disk searcher no longer searches memory first each time it is used, and it tells you where the string you are looking for is when it is located.

The changes are quite welcome and make it easier to use, and the SP remains a good value. All in all, the Senior PROM is still a must for the serious deprotector or programmer who needs total control over his Apple IIe or IIc.

(Nobody's perfect, especially me. After COMPUTIST No. 35 was printed, I was informed that a Low Profile version of the SP that doesn't block any long peripheral cards was also available from Cutting Edge Enterprises. Oh, well.)

softkey for...

Gemstone

by Red Williams

*Strategic Simulations
883 Sterlin Road, Bldg. A-200
Mountain View, CA 94043-1983*

Requirements:

At least 64K
Gemstone Warrior disk
A blank disk
A sector editor

After reading the review on Gemstone Warrior in Computist No. 27, I was sufficiently interested to try it out. The game fulfilled all my expectations: excellent control, hours of addictive action, smooth graphics. But the obnoxious protection scheme on the disk prevented my playing the game on my II Plus, whose disk drive speed is slightly off, and I had to go over to a friend's house to borrow his computer whenever I wanted to play. That annoyance prompted this softkey.

My first step was to examine the disk with a nibble editor. All the tracks showed normal address and data markers except for the data epilog, which had been changed from DE AA EB to CC 99 EB. In order to make the disk readable with DOS 3.3, and thus COPYAable, I must normalize the epilog to the standard DE AA EB. This was accomplished by copying the disk with COPYA after patching DOS slightly.

Before running COPYA, I modified DOS by telling it to ignore the data field epilog:

**CALL -151
B934:18 60
3D0G**

Then, using COPYA, I duplicated my Gemstone Warrior disk normally. The resulting copy had the standard data field epilog, and in fact could be CATALOGed. But the quest was

not over yet. Since the DOS on the disk also checked for the data epilog and expected to find CC 99, I had to patch up the DOS to look for the new epilog instead.

DOS 3.3's sector read routine resides on track 0, sector 3. Byte \$35 is where the \$CC of the instruction CMP #\$\$CC is stored and the \$99 is found at byte \$3F of the sector, so these were changed to \$DE and \$AA respectively with a sector editor. The sector write routine also had to be changed since the the high score and the game in progress are saved on the disk. The write routine is found at track 0, sector 2. Byte \$9E was changed from \$CC to \$DE, and byte \$A3 was changed from \$99 to \$AA. Now Gemstone Warrior's DOS could read and write the normalized disk format.

There is still one more obstacle in the way of a totally deprotected copy. During the boot, the game checks the nibble count on the disk in two places; if the nibble count does not conform to an expected range, the game reboots. My disk drive was a bit slow and the count is never within range, so the game would not run on my computer. With this in mind, I searched the disk with my sector editor to find likely places where the nibble counting was done.

Since disk reading is nearly always done with an LDA \$C08C,X instruction, I looked for all the occurrences of disk reads by searching for the bytes 8C C0. An initial round showed four possible places for the count: Track 5, sector 0; track 6, sectors \$B and \$D; and track \$A sector 6. The other occurrences were regular DOS-related disk access.

In order to determine which one was being called to do nibble counting, I inserted an instruction to exit into the monitor into each routine. Before exiting, the routine being called would be identified by a technique known as stac kextraction. During a Jump to SubRoutine (JSR) command, the computer saves its calling location on the stack. This will uniquely identify the calling routine and so all I had to do was

Warrior

extract and save the top two bytes on the stack before exiting to the monitor. The short routine to do this is:

```

PLA      ; extract first byte
STA $2000 ; save it
PLA      ; extract the next byte
STA $2001 ; save it
LDA $C082 ; enable motherboard ROM
JMP $FF59 ; and jump to the monitor
    
```

Since Gemstone Warrior uses the upper 16K RAM, the LDA \$C082 was required to turn off the language card and enable the ROMs where the monitor subroutine resided. I saved the small subroutine in an unused area of DOS (by using a sector editor) at \$BCDF. At each possible nibble counting routine I inserted the command JSR \$BCDF, which will cause the calling address to be saved on the stack for the routine to retrieve. Using this technique, I discovered the offending nibble counting routine was located at \$F261. The game does a nibble count in two places: during the initial boot and after the temple scene. It turned out both times the nibble count routine at \$F261 was called. The final step, then, is to seek out and nullify all calls to \$F261.

A call to the nibble count, JSR \$F261, would appear as 20 61 F2 on the disk. Using a sector editor, I scanned and found two occurrences of this string at track \$1F, sectors 4 and 5. I nullified both calls by replacing them with three NOP commands (EA EA EA). Now my copy of Gemstone warrior was completely deprotected! I was able to play the game on my][Plus for the first time, and now I had a backup in case of disk failure.

In summary, these are the steps to fully deprotect Gemstone Warrior:

- 1) Boot up DOS 3.3. Patch DOS to ignore the data epillog.

- 2) Exit the monitor and make a backup with COPYA.

```

3D0G
RUN COPYA
    
```

- 3) Use any sector editor and make these changes:

Track	Sector	Byte	Change to
00	2	9E	DE
00	2	A3	AA
00	3	35	DE
00	3	3F	AA
1F	4	01	EA EA EA
1F	5	01	EA EA EA

and you are all done. Gemstone Warrior can now be CATALOGed and examined.

CALL -151
B934:18 60

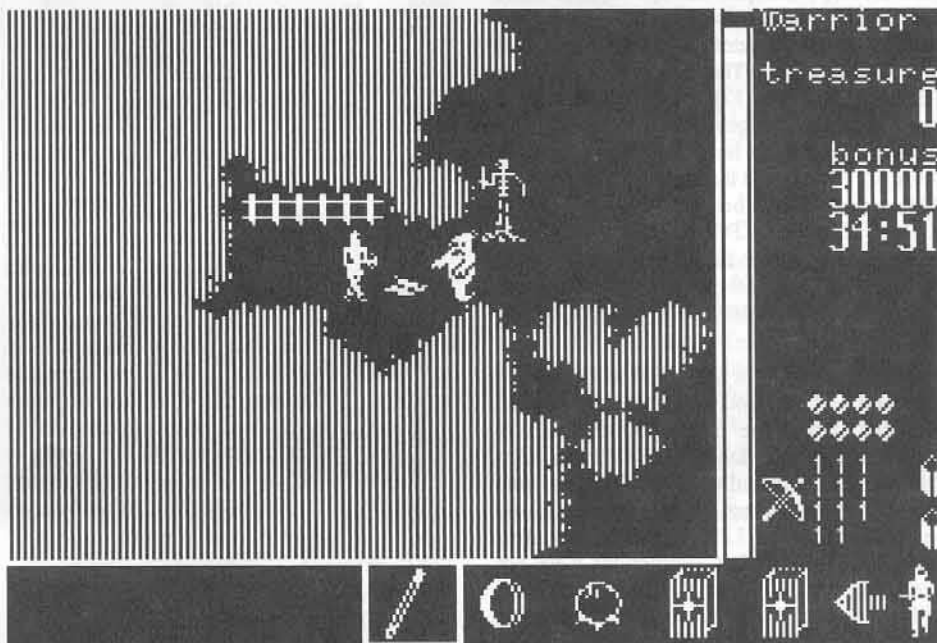

Printshop Printer Drivers

by Jerry Lewis

*The Print Shop
Broderbund Software
17 Paul Drive
San Rafael, CA 94903*

Requirements:

- Deprotected Print Shop or Print Shop Companion disk
- Sector editor with search functions
- A disk compare utility
- Blank disks

Last issue, I discussed methods of examining Newsroom to find out how printer card drivers are stored and called by the program so that you could add your own. This month, the focus turns to The Print Shop from Broderbund.

Like Newsroom, Print Shop is also a file based program. During the search for my print card driver, I snooped through its files using the same techniques discussed last month. The Print Shop VTOC needs some changes to get a catalog file listing. The softkey for Print Shop (COMPUTIST No. 17) discusses in detail the reasons for the changes to the VTOC, so I will be brief. Print Shop has two VTOCs, both on track \$11. The one at the normal location, track \$11 sector \$00, will bring you a message from the publisher. The VTOC used by the program is actually on sector \$02. Changing byte \$02 of sector \$00 from \$01 to \$09 (the first sector of the directory is sector \$09) will correct the problem.

My search of Print Shop lead me to the file PRCOMS which contains all the drivers used by Print Shop. The file PRCOMS loads at \$1800 and the section from \$1BB4 through \$1E61 contains the print drivers. The first time I looked at the drivers, I was surprised to see several sections of LDA instructions ending with RTSes. The LDA instructions were not going to get data to a printer but a little study will reveal that Print Shop uses the drivers in a different manner from Newsroom.

Print Shop Drivers

The listing below is part of the print driver routines from Print Shop. The addresses \$1D06, \$1D20 and \$1D41 are entry points for the first half of the driver routines (which I will call setup for lack of a better term). The primary purpose of the setup routines is to make any necessary slot address changes, prepare the card to receive output and check to see if the printer is busy.

1D06-	AD 1C 18	LDA	\$181C
1D09-	D0 08	BNE	\$1D13
1D0B-	EE 1C 18	INC	\$181C
1D0E-	A9 15	LDA	#\$15
1D10-	9D 80 C0	STA	\$C080,X
1D13-	BD 81 C0	LDA	\$C081,X
1D16-	BD 80 C0	LDA	\$C080,X
1D19-	49 02	EOR	#\$02
1D1B-	60	RTS	
1D1C-	9D 81 C0	STA	\$C081,X
1D1F-	60	RTS	
1D20-	8C 2F 1D	STY	\$1D2F
1D23-	BD 80 C0	LDA	\$C080,X
1D26-	4C 4A 1D	JMP	\$1D4A
1D29-	48	PHA	
1D2A-	AD FF CF	LDA	\$CFFF
1D2D-	AD 00 C1	LDA	\$C100
1D30-	68	PLA	
1D31-	8D 00 C8	STA	\$C800
1D34-	8D 01 C8	STA	\$C801
1D37-	8D 00 C8	STA	\$C800
1D3A-	8D 01 C8	STA	\$C801
1D3D-	AD FF CF	LDA	\$CFFF
1D40-	60	RTS	
1D41-	8C 51 1D	STY	\$1D51
1D44-	8C 49 1D	STY	\$1D49
1D47-	AD F9 C1	LDA	\$C1F9
1D4A-	29 40	AND	#\$40
1D4C-	49 40	EOR	#\$40
1D4E-	60	RTS	
1D4F-	8D FD C1	STA	\$C1FD
1D52-	60	RTS	
1D53-	48	PHA	
1D54-	AD FF CF	LDA	\$CFFF
1D57-	8A	TXA	
1D58-	A8	TAY	
1D59-	99 80 C0	STA	\$C080,Y
1D5C-	68	PLA	

1D5D-	20 00 C8	JSR	\$C800
1D60-	99 81 C0	STA	\$C081,Y
1D63-	AD FF CF	LDA	\$CFFF
1D66-	60	RTS	

The first thing the routine at \$1D06 does is to determine if the byte at \$181C is zero. This is seen frequently throughout the routines. The byte will be zero for the first execution of the routine, but \$181C is incremented by the setup routine, which will change the program flow on subsequent executions. The most frequent reason for program flow modification is to skip the driver address changes and card command instructions (here the STA of a  (\$15) is skipped the second time through).

The indexing of the slot I/O addresses with the X register in the listing indicates that X contains the slot value in the form \$s0. Examination of where the Y register is stored by the setup routines at \$1D20 and \$1D41 shows that the Y register contains the slot value in the form \$Cs. Notice how two routines share a set of instructions at \$1D26. The JMP \$1D4A allows two setup routines to use the same code to determine the printer status. Also notice that the X and Y registers still contain the slot information when the setup routines are exited.

Is the Printer Busy?

The Print Shop determines a printer-busy status in a different manner from Newsroom. At the end of the setup routines (\$1D47-\$1D4E) you will see AND and EOR instructions to set or clear accumulator data bits. When the setup routine returns to the program that called it, the zero flag is checked to see if the last value loaded in the accumulator was zero. In this case, if the AND and EOR of the accumulator results in zero, the zero flag will be set and signals the program that the printer is not busy and is ready to receive data.

The listing above has a good example of detecting the change in a single bit to determine printer status. The instruction at \$1D47 loads the accumulator with the value from \$C1F9. The value is the ANDed with a value of \$40 as a "mask." The AND instruction means that the resulting value will have ones ONLY where the bits in \$40 and the bits in the accumulator are BOTH ones. The bit pattern for \$40 is 0100

0000, thus only bit six could possibly be a one since all others are zero.

The EOR instruction at \$1D4C causes a value of 1 if either bit is 1 (but not if both bits are). Since the AND instruction forced all bits except six to zero, and all bits in \$40 are zero except six, only bit six could possibly be one. Thus the status of bit six will reflect the status of the printer. The value of \$40 in both the AND and EOR instructions is to mask out unwanted bits and let only certain bit patterns through.

Example: Accumulator holds the value from \$C1F9. Bit 6 is singled out by the AND instruction, and the EOR reverses the value of the bit.

printer is:	(ready)	(unready)
Accumulator	?1?? ???? ?0?? ???? ?0?? ???? ?0??	AND # \$40 0100 0000 0000 0000
Accumulator	0100 0000 0000 0000	EOR # \$40 0100 0000 0100 0000
Accumulator	0000 0000 0100 0000	

As can be seen from the above example, if bit six goes high, a value of zero results in the accumulator. When the accumulator is loaded with zero, the zero flag is set and the program will then know (using BEQ) the printer is not busy and send the data to be printed.

Data Output

The second half of the drivers (which I will call output) sends the data to the printer. The two output routines at \$1D1C and \$1D4F are simple, having only one instruction. The other two at \$1D29 and \$1D53 are more complex and the references to \$CFFF immediately tells us that they are for cards with onboard ROM that uses the 2K area starting at \$C800. The reference to \$C100 at \$1D2D shows that even with ROM in the \$C800 area, the slot ROM area is still accessible.

There is one item of interest, used by some of the setup and output routines, that is not shown in the listing. The address location \$1823 is used by several routines for temporary storage. One use seen in some drivers is storage of the X register at \$1823 during the setup routine execution, and then during the output routine execution the Y register is loaded from \$1823. This has the effect of transferring the slot value in the form \$s0, from the X to the Y register for use by the printer card ROM.

Look Familiar?

The routine listed at \$1D53 should be familiar; it was the source for the Fingerprint card driver routine patched into Newsroom last month. Comparison between the two will show that, because of the different demands of the two programs, some changes to the driver were required.

Examination of the Fingerprint driver routines for Newsroom and Print Shop will show that there is no check of the printer status. This requirement is taken care of by the card's ROM and does not have to be done by the

Table 1

DRIVER	\$95F2	SETUP	OUTPUT
Epson APL	\$01	\$1BB5	\$1BEE
Orange Interface, Grappler	\$02	\$1BCE	\$1BD4
Grappler +	\$03	\$1BDE	\$1BEE
Apple Super Serial	\$04	\$1C9F	\$1CDA
Apple Parallel	\$05	\$1BE6	\$1BEE
*Apple III Serial	\$06	\$1C0F	\$1C2D
*Pkaso	\$07	\$1D20	\$1D29
ALS Printermate	\$08	\$1DD8	\$1BF5
Star Micronics Grafstar	\$09	\$1BCE	\$1BD4
Tymac PPC 100, Tackler	\$0A	\$1BB5	\$1BEE
Microtek Dumpling GX	\$0B	\$1C31	\$1C3F
Microtek Dumpling 64	\$0C	\$1C39	\$1C45
Microtek RV-611C	\$0D	\$1BB5	\$1BEE
Microtek SV-611C	\$0E	\$1C4F	\$1C6E
Prometheus Graphitti	\$0F	\$1BB5	\$1BEE
Prometheus Versacard (parallel)	\$10	\$1BB5	\$1BEE
*Prometheus Versacard (serial)	\$11	\$1D67	\$1D81
Videx Uniprint	\$12	\$1C9F	\$1CDA
Videx PSIO Parallel	\$13	\$1BB5	\$1BEE
Videx PSIO Serial	\$14	\$1C4F	\$1C6E
*Mountain CPS Parallel	\$15	\$1D41	\$1D4F
*Mountain CPS Serial	\$16	\$1D85	\$1DA9
MA System Omnigraph	\$17	\$1DD8	\$1C49
Practical Peripherals Serial	\$18	\$1C4F	\$1C6E
Practical Peripherals Printerface	\$19	\$1BB5	\$1BEE
Practical Peripherals (other)	\$1A	\$1BC2	\$1BBE
CCS 7728,7229	\$1B	\$1DDE	\$1BBE
CCS 7731	\$1C	\$1DFE	\$1D1C
CCS 7710	\$1D	\$1DE4	\$1D1C
Happicard	\$1E	\$1BB5	\$1BEE
Fourth Dimension	\$1F	\$1BB5	\$1BEE
MPC Parallel	\$20	\$1BB5	\$1BEE
MPC AP-SIO or SSM A10-11 Serial	\$21	\$1E06	\$1E20
Okidata Plug and Play (Graphics on)	\$22	\$1BB5	\$1BBE
Okidata Plug and Play (Graphics off)	\$23	\$1BCE	\$1BD4
Perisoft Printerlink	\$24	\$1BB5	\$1BBE
Perisoft Messenger	\$25	\$1D06	\$1D1C
SSM APPIC	\$26	\$1BB5	\$1BBE
*SSM ASIO	\$27	\$1C72	\$1C91
SSM APIO or A10-11 Parallel	\$28	\$1DD8	\$1E24
Techport Paragraph - 1	\$29	\$1E18	\$1E20
Macrotech Macroprint	\$2A	\$1BB5	\$1BEE
Macromax Printmax, Graphmax	\$2B	\$1BB5	\$1BEE
*Franklin Ace Dual Interface	\$2C	\$1E50	\$1E61
Thirdware Fingerprint	\$2D	\$1DD8	\$1D53
Spies Super-MX (Niceprint)	\$2E	\$1BC8	\$1BD4
Wesper Wizard	\$2F	\$1DAD	\$1DDB
Texprint Print-it	\$30	\$1C95	\$1CDA
Apricorn Parallel	\$31	\$1BB5	\$1BEE
Apricorn Serial	\$32	\$1DE4	\$1D1C

driver. Those cards in Print Shop not needing a setup routine are sent to \$1DD8 where a LDA # \$00 and RTS are executed. The LDA # \$00 sets the zero flag and satisfies the printer not busy requirement upon return to the caller. The setup routine for the Fingerprint card goes to \$1DD8 and therefore there is no opportunity to use \$1823 for temporary storage, thus the Fingerprint driver has to get \$s0 from the X register to the Y register via the accumulator.

Print Shop Setup Storage

Where Newsroom only loaded the printer and card information that was to be used, Print Shop loads all the card and printer information. To

access the correct parts of the driver routines for the selected interface card, Print Shop uses two sets of address tables. During the setup menu, the selected printer, card, and slot information is stored in the file CONFIG. Besides storing the information for output, CONFIG also contains additional information about the Apple system using the program.

The file CONFIG loads at \$95F0 and contains the following data:

- \$95F0 - Printer interface card slot in the format \$0s.
- \$95F1 - Printer selection (\$01 through \$06).
- \$95F2 - Interface card selection (\$01 through \$32).

\$95F3 - Disk drive slot in the format \$0s.
\$95F4 - Number of disk drives (\$01 or \$02).
\$95F7 - If \$00, Setup has not been run.

Accessing the Driver

The following listing is the routine to access the drivers and has two entry points: \$1ABB and \$1ABD. Many printer commands use Escape (\$1B), and the entry at \$1ABB loads the accumulator with \$1B, making it readily available. The normal entry point is at \$1BBD, and immediately stores the X and Y registers which will be retrieved before the routine is exited. Just as in Newsroom, the accumulator (data) is saved on the stack by the PHA instruction at \$1ACA, and is later retrieved to be carried back to the caller.

The value for the selected interface card is loaded from \$95F2 (see the LDX instruction at \$1ACB) and is used as the index to get the address values for the output routine from the data table. The output routine address table low bytes are stored starting at \$1AE3 and the high bytes starting at \$1B1F. The address of the output part of the driver is setup in the JSR instruction at \$1AE2, replacing the \$8000 address. There is a JSR instruction at \$1ADB, which is executed before going to the output routine. The JSR \$1E64 instruction is to access the setup routine.

The setup routine address is located in the same manner as the output, using the byte from \$95F2 as the index to the setup address data tables at \$1B51 (low byte) and \$1B83 (high byte). Before going to the setup routine via a JMP instruction the X and Y registers are loaded with the slot information. The JMP instruction causes the setup routine to return to the following listing at \$1AED. The instruction at \$1AED then checks the zero flag (printer busy?) upon return and if the flag is not set, it is back to the setup routine until the zero flag is set.

```

1ABB- A9 1B      LDA #$1B
1ABD- 8E 1D 18  STX $181D
1AC0- 8C 1E 18  STY $181E
1AC3- 18        CLC
1AC4- 69 09     ADC  #509
1AC6- EA        NOP
1AC7- 38        SEC

```

```

1AC8- E9 09     SBC  #509
1ACA- 48        PHA
1ACB- AE F2 95  LDX  $95F2
1ACE- CA        DEX
1ACF- BD ED 1A  LDA  $1AED,X
1AD2- 8D E3 1A  STA  $1AE3
1AD5- BD 1F 1B  LDA  $1B1F,X
1AD8- 8D E4 1A  STA  $1AE4
1ADB- 20 64 1E  JSR  $1E64
1ADE- D0 EB     BNE  $1ACB
1AE0- 68        PLA
1AE1- 48        PHA
1AE2- 20 00 80  JSR  $8000
1AE5- 68        PLA
1AE6- AE 1D 18  LDX  $181D
1AE9- AC 1E 18  LDY  $181E
1AEC- 60        RTS

```

I have been unable to determine the purpose of the instructions from \$1AC3 through \$1AC9. The addition of \$09 followed by the subtraction of \$09 results in the original value. Thinking that the program could store an instruction at \$1AC6, I searched the Print Shop disk but did not locate any references to \$1AC6.

All the Driver Parts

Table 1 is a list of Print Shop interface cards with the selection values stored at \$95F2 and the addresses of the setup and output sections of the drivers from the appropriate address table. Notice that a setup or output routine can be used by several different cards.

It is only a guess, but it makes sense. When writing a program, such as Print Shop, you want to put as many print cards in the menu as possible. After the print card drivers are gathered together, you begin to notice that some sections of them are the same. With the drivers broken down into smaller routines and the use of address tables, the cards can share the same routines, avoiding repetition of the same instructions for several cards. Apparently this is what Print Shop has done.

Patching Print Shop

Even though the utilization of the driver routines in Print Shop is slightly more complex than in Newsroom, patching another driver is easily done. Before we discuss how to patch Print Shop, one thing needs to be kept in mind.

Fewer problems will be encountered when altering a program if the disturbance to the existing code is minimized. Applying this to Print Shop means that the printer output entry points are best maintained at \$1ABB and \$1ABD, especially since there are so many calls to these addresses from the printer command routines.

Print Shop does not lend itself to adding on a print driver; instead we will have to overwrite some part of the existing program. The simplest method to add a driver routine is to identify existing setup and output routines that will work with your printer card. If you are fortunate enough to locate such a combination, all that needs to be done is pick a printer card in the setup menu to replace. The card name should be replaced with the name of your card, and using the value stored at \$95F1 for the replaced card as the index, edit the address tables with the new address bytes.

The second method is to select a printer card for replacement that does not share any of its setup or output routines. There are seven cards that are possible candidates and are marked in Table 1 with a '*'. Replace the routines for the selected card with your routines and then update the printer card name list with your card. Updating the address data tables would not be required with this method, since the same entry points are maintained.

There are two disadvantages to both these methods, the first being that you have to determine how to divide your driver into the two necessary subroutines. The second problem is getting the zero results necessary for the printer not busy upon return from the setup routine. The division of the drivers and check for the busy signal in Print Shop is not the standard method and will not be explained in the documentation for your printer card.

Sewing Another Patch

Using the driver as a single routine, as is done in Newsroom, avoids both these problems. Returning to our example, the driver for the original Fingerprint card, and examining how it could be patched into Print Shop, we will see that it can be simply done. The boxed listing (Listing 1) with this article is the patch for the Fingerprint card driver that I successfully installed in Print Shop for this example.

Keeping with the adage, "If you don't understand it, leave it alone", the instructions from \$1AC3 through \$1AC9 were left intact and the patch starts at \$1ACA. Examination of the routine will reveal that it is not dependent on the value stored in CONFIG for the selected printer card, thus the patched driver will be executed regardless of the card selected. The necessary forms for the slot information are determined and since the driver for Fingerprint requires \$s0 in the Y register, \$s0 is placed there instead of in its normal location, the X register. The value \$Cs is also determined for consistency, even though it is not required.

If your print driver needs address changes or special setup characters for output, the necessary instructions should be inserted starting at \$1AD6. The instructions can be

Table 2

\$95F1 - Data in the file CONFIG for printer selected.
 \$1844 - Entry address to comparisons for printer setup routines.
 \$1897 - Entry address to comparisons for enter graphics mode routines.
 \$1909 - Entry address to comparisons for exit graphics mode routines.

SETUP, ENTER, and EXIT are the specific addresses where the command sequence routine starts for each printer group.

PRINTER	\$95F1	SETUP	ENTER	EXIT
Epson MX-,FX-,RX (80 or 100)	01	\$1855	\$18C4	\$1A2C
Old Epson with Graftrax-80	02	\$1855	\$18AE	\$19F0
C-ITOH (Prowriter) or NEC 8023	03	\$1855	\$18E8	\$1A30
Apple DMP, Imagewriter, Scribe	04	\$1861	\$18E4	\$1A30
Okidata Microliner 92,93	05	\$1885	\$18D4	\$1A6D
Star Gemini 10X,15X, Delta, Radix	06	\$1855	\$18C4	\$1A2C

skipped over after the first pass by use of \$181C as previously discussed. Be aware that if you turn off your card after each data byte is sent, you may not want to skip over any instructions.

The advantage of patching Print Shop in this manner is that the address tables are not used and the routine is not broken up into two separate routines. The driver (or ROM) does the check for the printer busy signal and when the printer is ready, the data is sent.

Printer Card Names

The Print Shop printer and printer card names are contained in the file MENUS7 and are entered with the high bit clear. Each name is separated from the rest with a \$00. Select a current card to replace, enter your card and fill any extra space with \$20 (space). When the setup menu is run, select your card to update the file CONFIG so your card is displayed if you check the setup. With a patch entered as suggested above, the value stored for your card is not used, so the card replaced is not critical.

Print Shop Printers

The file PRCOMS from \$1826 through \$19CB contains the routines for printer commands. Close inspection will show that there are three sections of printer commands, printer initialization, enter graphics mode and exit graphics mode. (Sound familiar?) The printer selection value from CONFIG, byte \$95F1, is loaded in the accumulator and then a set of comparisons are made to determine where to go for the correct printer command sequence for the selected printer.

Table 2 gives the specifics regarding the addresses for the various routines and specific printers. Addition of a printer to Print Shop would require that the printer command section be thoroughly understood. The addition would not be as simple as in Newsroom as the existing routines would require alteration or replacement with new routines to control the added printer. The best solution is to totally customize the file PRCOMS by overwriting the existing printer routines.

The three sets of instructions for your printer (initialization, enter graphics mode, and exit graphics mode) should each be inserted at the appropriate three entry address. Since this would maintain the same entry points, other portions of Print Shop should not require alteration. The value in the file CONFIG for printer selection would not be used and as in the driver patch, would be meaningless.

Print Shop Companion

Print Shop Companion expands the capabilities of Print Shop and provides additional graphic editing capability. It is a nice supplemental addition to Print Shop. It does not stand alone, but is dependent on Print Shop for its system setup information. Fortunately for us this is a boon, because if you had to patch Print Shop, you are almost ready to use Print Shop Companion.

The first thing we need is an unprotected backup of Print Shop Companion, which is

simple to obtain. Copy both sides of the original disk with your favorite copy program and ignore any read errors on track \$22 which is used for a nibble count. Then grab your sector editor and make the following edits:

Track	Sector	From	To
\$00	\$04	\$9B	\$01
\$03	\$06	\$A0	\$60

The first edit is to disable the self copy feature and the second is to skip the check for copy protection.

Print Shop Companion also has two VTOCs. Cataloging the disk will give a file listing, but it is incomplete. By changing byte \$02 of track \$11, sector \$00 from \$0D to \$0F you can see all the files. When you now catalog the disk, you will be greeted by two old friends, the files CONFIG and PRCOMS.

There is also a file called SETUP, but its function is different from the SETUP file in Print Shop. Print Shop Companion does not have a output setup menu but depends on Print Shop for its printer, interface card and system information. When you run the setup menu and select to update the Companion disk, one thing that happens is that the file CONFIG on the Companion disk is setup with the necessary data.

The real surprise is that the file PRCOMS is COPIED from Print Shop to Print Shop Companion. I discovered this when I ran the configuration program of Print Shop Companion with the file PRCOMS on the Print Shop disk patched with my example for the Fingerprint card. The patch appeared in the file PRCOMS on the Companion disk and when I tested Print Shop Companion with the patch, it worked fine.

After Configuration was run, I did a

comparison of the PRCOMS files on each disk. I found that there are four byte differences in the two files. All were the same and had to do with changing the address of a common JSR instruction. The file PRCOMS could be loaded from the Print Shop disk and then correct the four addresses prior to saving it back to the Companion, but it is easier just to run the configuration of Print Shop Companion.

Parting Thoughts

The information here is sufficient to allow you to patch Print Shop with your own driver routine, but the techniques and concepts apply to patching a driver in any program. Experiment with the program, the worst that can happen is that you will have to start over. Much of the information presented was obtained by trial and error. When you're experimenting, just remember to try only one thing at a time so you can evaluate the effects of a single change.

Although the printer information is incomplete, there is enough to provide a starting point for anyone who needs or wants to experiment. If during a period of trial and error, your printer or system does not work, you may have to turn your printer off and back on to clear the bad commands. Not doing this may result in looking for a program bug that does not exist. (Sounds like the voice of experience.)

Both Print Shop and Newsroom are great programs and have increased my consumption of paper and ribbons. Hopefully the preceding will allow more to enjoy the pleasure of seeing their creative efforts appearing over the platen.



Listing 1

1AB8- A9 1B	LDA #\$1B	Escape for printer use
1ABD- 8E 1D 18	STX \$181D	Save X for exit
1AC0- 8C 1E 18	STY \$181E	Save Y for exit
1AC3- 18	CLC	?
1AC4- 69 09	ADC #\$09	?
1AC6- EA	NOP	?
1AC7- 38	SEC	?
1AC8- E9 09	SBC #\$09	?
1ACA- 48	PHA	Save data for exit
1ACB- AD F0 95	LDA \$95F0	Get selected slot
1ACE- 09 C0	ORA #\$C0	Slot to form \$Cs
1AD0- AA	TAX	\$Cs to X
1AD1- 0A	ASL	Multiply slot by \$10
1AD2- 0A	ASL	To get to the form \$s0
1AD3- 0A	ASL	
1AD4- 0A	ASL	
1AD5- A8	TAY	Put \$s0 in Y
1AD6- AD FF CF	LDA \$CFFF	Turn off all slot ROMs
1AD9- 99 80 C0	STA \$C080,Y	Turn on printer card
1ADC- 68	PLA	Get data for output
1ADD- 48	PHA	Save on stack for exit
1ADE- 20 00 C8	JSR \$C800	Go to card ROM
1AE1- 99 81 C0	STA \$C081,Y	Turn off the card
1AE4- AD FF CF	STA \$CFFF	Turn off all ROMs
1AE7- 68	PLA	Get data for exit
1AE8- AE 1D 18	LDX \$181D	Get X for exit
1AEB- AC 1E 18	LDY \$181E	Get Y for exit
1AEE- 60	RTS	Return to caller

The Games of 1986

by Jeff Hurlburt

This month, the emphasis on adventuring. The final wrap up of this category will appear next month.

While pure arcades command an ever shrinking share of game production, adventures continue to proliferate, often incorporating arcade sequences which once would have been released separately. Much the same sort of cooption has occurred with simulations and other game forms. Everything, it seems, plays better (and longer) as an adventure; and, with the best numbers, variety, and overall quality ever, 1986 has been a super year for computer wizards, warriors, explorers, and detectives.

My goal in these reviews is to make it easier for you to zero in on the best values for YOUR entertainment dollar. At a local software parlor it's difficult to give even one adventure (let alone several) much of a tryout; so each review aims to supply the maximum information in the space available. Game type and, if multi-player, number of players for which the product is designed are shown up front, along with peripherals requirements/options and machine compatibility. I've tried all the games on the IIGs; and "Apple II series" now includes the new gs model. The bulk of each review describes the game, with the remainder devoted to critique, publisher information, pricing, and ratings.

Comments and ratings reflect my evaluation based upon playing a game and, sometimes, watching as others try it. Each game is rated

in five areas and "overall" on a ten-point scale: 10=Superior (rarely awarded; indicates a breakthrough of some kind), 09=Excellent, 07=Good, 05=Fair, 03=Poor, 01=Rotten.

Graphics (GRFX) is the first area rated. It concerns quality of artwork, clarity, impact, smoothness, speed, and realism. Good **Support Materials** (S.M.) include clear, thorough directions for play. In some cases attractiveness, tutorial value, or effectiveness in creating 'atmosphere' may be important. **Playability** (PLAY) relates to how much extraneous activity is required to play the game. Good parsing, rapid "save" and "restore" functions, efficient menus, smooth controls, and readily available "Help" screens are features which enhance playability.

Difficulty (DIFF) is self-explanatory for single-player games. For others it relates to how much effort is required to achieve a decent level of play. Unlike other areas, the rating here simply reflects "level of". An "8" is "very tough", which may or may not equal "very good". High **Interest** (INTR) games are good at attracting and holding player attention. Typically, these are the adventures you can't wait to continue and the arcades you play, and replay, for hours at a time. The **Overall** (GAME) rating amounts to a summary of player reaction(s) during tryouts. For educationally-oriented games, a second summary rating (/ED) of **educational value** is included.

In case you are relatively new to adventure gaming, here are a few guidelines which may help in selecting the best entertainment values: Text and picture-text adventures tend to be problem/puzzle oriented; so they are especially well suited to multi-player participation. Picking an attractive scenario is important, since for

maximum enjoyment you must be willing to involve yourself in the game situation. Other adventures are beefed-up simulations (flight, space war, etc.) which usually incorporate low to medium difficulty action sequences. Some of these can be very long-playing, whereas others are short duration contests offering high scores competition and multiple replays. Finally, map and map-maze adventures like the *Ultimas*, *Questron*, *Bard's Tale*, etc. all emphasize exploration, combat, and character development. Often these are the longest playing of games; so if you find one you like, you're in for many hours of fun.

Airheart

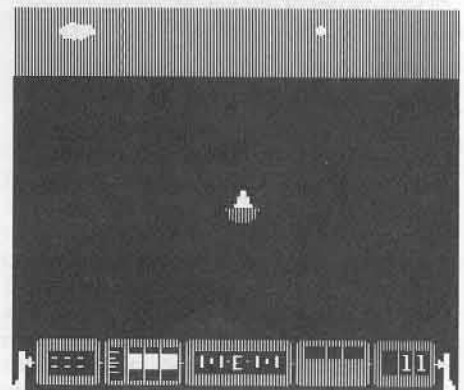

(Adventure Arcade)

Compatibility: 128K Iie, Iic, Iigs

Requirements: One disk drive, joystick

When Marinus, Lord of the Sea, realized that his kingdom would soon fall to merciless invaders his final arrangements were to protect

his only son. Locked in suspended animation and surrounded by robot defenses, the prince may only be awakened by one brave and skillful enough to pass four great tests. For only with such a one at his right hand can the prince hope to free his people- only with the hero to be known as "Airheart"!

As the challenge begins you are seated in a small, jet-powered one-gun skimmer craft in mid-ocean between the two "Home" islands. On each stands a solemn guardian; as one, they point to the open sea: "Bring us the sword", they command, and then vanish. If successful, you will subsequently be directed to recover a goblet, a harp, and finally the prince himself. Each item retrieved earns an extra life and adds to your score. Losing your last life ends the game; however, you may still qualify for High Score honors (saved to disk).

All of the tests follow the same format. You must track your way (above or below the surface) to the "Treasury" island, defeat the robot defenders, board the island to retrieve the object, and return to the Home islands. Since your craft is vulnerable to being shot out from beneath you, on the way back there is a brief robot-fighting contest to win an extra skimmer.

The higher the task, the tougher and more numerous the defenders. These include seven types of buoy-shaped machine that can bump you, fire bullets, suck up your skimmer, and send out suffocating bubbles, among other talents. Knocking out robots takes a bit of practice, since you must control shot distance by tilting your craft; and, naturally, the robots are always in motion. Finally, even after potting one of these turkeys, you have to quickly scoop up the leftover "pod"; otherwise, the robot regenerates!

This is the first double hi-res arcade I've seen; so the colorful, detailed, smoothly animated graphics were something of a surprise. Add good sound, and the result is a very attractive presentation; just watching the demo sequences is a treat. The acid test, of course, is to tackle an actual mission. With good speed and responsive controls for tilt, up/down motion via jets, and full-circle horizontal motion, the skimmer is fun to fly and fight. Brought to you from the creators of *Choplifter*, Broderbund's *Airheart* is a solid arcade challenge sure to become a classic.

Available from: Broderbund, 17 Paul Drive, San Rafael, CA 94903. (415) 479-1700. \$34.95

GRFX	S.M.	PLAY	DIFF	INTR	GAME
09	07	08	07	08	09

Wizard's Crown

(Map-Maze Adventure)

Compatibility: 48K Apple II, II+, IIe, IIgs, III
Requirements: One disk drive; second drive, SpecDemon optional

For centuries the Fellowship of Wizards ruled glorious Arghan wisely and well, an

achievement due in no small way to an artifact known as "The Crown of the Emperor". Great power is conferred with the crown's wearing; so this privilege was regularly rotated among the Fellowship- that is, until one wearer decided that he would just as soon keep it for himself! Thus did Tarmon, Wizard of Thunder, provoke a war of magic, monsters, and steel from which Arghan has yet to recover.

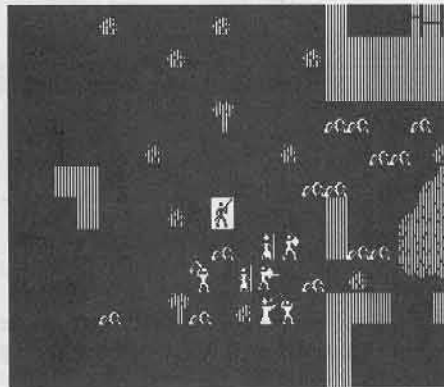

In this SSI fantasy your party of up to eight worthies sets out to recover the crown, still worn by Tarmon, who has modestly renamed it the "Wizard's Crown." Your base of operations is an inn located within the walled core of the once great city state. Here you find buyers and sellers of weapons, armor, and even magical services, along with training grounds, shrines for healing, and taverns to boost morale- in short, everything needed to launch a first class quest. Tarmon, meanwhile, is securely ensconced in his castle deep within the vast, monster-infested Ruins to the south. Though you must ultimately face down the evil wizard on his home turf, most of the game is concerned with improving your characters, obtaining better equipment, gathering information, and locating certain key artifacts.

Wizard's Crown involves a good deal of moving about, usually as a single warrior figure on the large, scrolling Ultima-type map. Exceptions are during combat and exploration of a few important sites, when party members and any adversaries show up as individuals. At such times you can direct each character's movement and actions via single-key commands. If outdoors, walls, trees, ponds and other terrain features may appear; while in a room, objects like tables, chests, and bookcases will be shown. You can almost always execute a search, and may, to a limited extent, manipulate and sometimes take items. For many players the major benefit of such detail will be the unusually involved combats, with your stalwarts maneuvering around obstacles, isolating groups of monsters, and smashing the enemy with tactical brilliancies (though you may opt for rapid, no-tactics "computer resolution"). Detail also adds a depth and richness more typical of picture-text adventures, nowhere more evident than in the game's finale. Tarmon's castle is a sprawling, multi-level affair replete with hidden passages, traps, puzzles, real dungeons, and a wicked little maze that will drive you right up the wall unless you can find the map. Virtually a second adventure,

the 'castle quest' is more involved than some complete games.

Offering clear, attractive graphics, adequate save/restore, and decent speed, *Wizard's Crown* reminds me of my current Nth-modification version of Instant Software's venerable *Santa Paravia*- i.e., the game is an incredible kluge which just happens to be fun to play. Extensive character development incorporates the usual "fighter", "sorcerer", etc. professions, attributes, and some thirty "skills;" yet an elaborate system for weapons grading and improvement makes "what you've got" fully as crucial as "who you are". While there are all sorts of spells, magic is not very important; and one profession, "ranger", confers skills which are never practiced. Top all this off with rambling, poorly organized documentation- but add a touch of humor- and, shazam!, you have a long-playing, thoroughly enjoyable adventure. Available from: Strategic Simulations, 1046 N. Rengstorff Ave., Mountain View, CA 94043-1716. (415) 964-1353. \$39.95

GRFX	S.M.	PLAY	DIFF	INTR	GAME
07	05	07	07	08	08

Elite

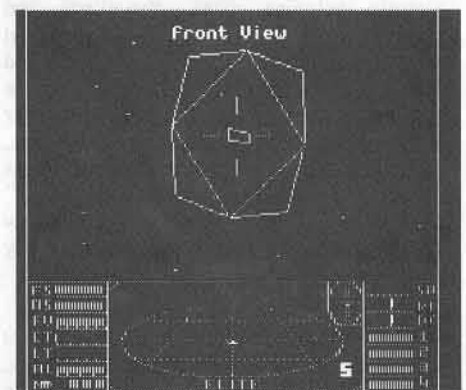

(Space Flight/Combat Simulation/Adventure)
Compatibility: 64k Apple II+, IIe, IIc
Requirements: One disk drive, joystick optional

In a two-thousand world, multi-species civilization there are many paths open to those unwilling to become 'planet bound'. Few, however, can rival the freedom, challenge, and opportunity for glory offered by life as an independent trader. Firebird's "Elite" places you at the helm of your own "Cobra" class fighter-trader craft. You begin with only 100 credits, enough hyperspace fuel to reach several neighboring planets, and a rating of "harmless". (Which, with only a single, front-mounted pulse laser, pretty well describes your situation.) Ostensively, your only aim is to achieve "Elite" status- no easy feat, since ratings are based solely upon hard won combat kills, but there are hints, supplied in an accompanying novelette, of still greater goals. Thus, you are lured by tales of a mysterious, Elite-only organization known as "The Dark Wheel"; and legends refer to a mythical planet, Raxxla, said to be a gateway to the knowledge and wealth of other universes!

Elite's universe spans eight 250-planet galaxies. Each planet trades in a variety of legal and contraband goods ranging from staples through luxuries, and raw materials through high-tech devices- seventeen in all. Prices vary depending upon such characteristics as government (anarchy, feudal, ...), inhabitants (insects, birds, human, ...), main products (agricultural or industrial), and development (tech levels 1-14). Tech level also determines availability of such equipment upgrades as more hold space, better weapons, fuel scoops, extra energy banks, an inter-galactic drive, etc.. These, in turn, improve efficiency and combat performance, allowing more profitable commercial ventures and greater freedom to explore. A host of factors, especially government and cargo, affect the hazardousness of trade. For example, a "harmless" rated beginner who approaches an anarchy planet with a cargo of narcotics might just as well press "destruct"; but few pirates will be encountered near corporate state worlds, especially with cargoes like wines or furs.

All buying and selling occurs on orbiting space stations; you never actually land on a planet. Docking, hyperspace jumps, approach, and any combats are handled via comprehensive controls including speed, dive/climb, and rotate- all in full 3-space- with button-activated laser fire and keyboard missile targeting and launch. The cockpit display includes a large view of nearby space plus an excellent radar screen and indicators for shields, energy banks, speed, etc.. To aid in route planning, hi-res "Current Galaxy" and "Local Star Group" displays with "star-finder" cursors allow immediate access to data (except prices) on any of some 250 planets.

Featuring fast 3-D line graphics, efficient save/restore, and a cleverly arranged data base, *Elite* is a well-executed blend of trading strategy, arcade, and mystery. Combats, which may involve one or more of several types of opponents, are very realistic with ships zooming in, laser fire tracers and good sound cues for hits and misses. Arcade ace skills are helpful; but success depends more upon combateer smarts and equipment than quickness. There are some interesting surprises, touches of humor, and you don't have to be a 'good guy' to make progress. (Still, though piracy can be exciting, it really doesn't pay well.) Supplied with a flight manual, ship ID chart, and an entertaining, hint-packed novelette, *Elite* delivers what all those bogus trekkie spin-offs only promised- a super long-playing, action-packed, incredibly addictive space adventure good for galaxies of fun.

Available from: Firebird, P.O. Box 49, Ramsey, NJ 07446. (201) 444-5700. \$34.95

GRFX	S.M.	PLAY	DIFF	INTR	GAME
07	09	08	07	09	09

Gunslinger

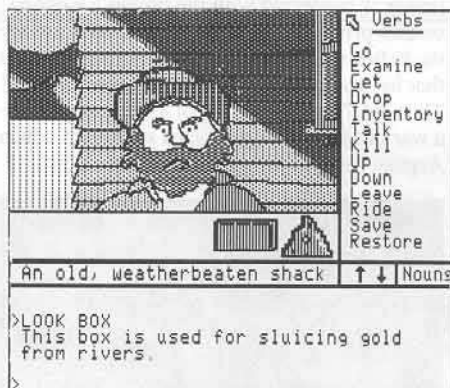

(Picture/Text Adventure)

Compatibility: 48K Apple II series

Requirements: One disk drive; joystick optional

As Kip Star, former Texas Ranger, you've spent a few peaceful years just wandering around the West. Then, one day, you hear that an old Ranger pal, James Badland, is fixin' to get himself hanged down in Mexico! In DataSoft's *Gunslinger* your mission to prevent an unfortunate miscarriage of justice soon mushrooms into a mini-war with the dangerous Dalton brothers; and you know, for sure, there's no hangin' up your irons 'til the Big Showdown!

With over one hundred hi-res frames *Gunslinger* takes you to ghost towns, saloons, abandoned mines, army forts, indian villages, and more. Throughout, your main concerns are gathering information pointing to your next destination and finding or trading for needed items. Often, too, you will need money to buy supplies, pay for tickets, and similar necessities. Gambling is one way to wealth; another, slightly safer, route is working "mined-out" gold diggings. Either way, make sure your sixgun is loaded and loose in the holster. One slip and it's your money AND your life!

A remarkably violent beginning-level adventure, the game offers multi-position save/restore and employs simple, yet entirely adequate parsing. While most players will prefer keyboard entry of text, the joystick controlled "word-selector" option does allow you to scroll through all operational verbs, nouns, and prepositions (i.e. a sort of built-in hint generator). Featuring a plethora of puzzles and almost as many well-drawn pictures as cliches,

Gunslinger is sure-shooting fun for new adventure gamers.

Available from: DataSoft, 19808 Nordhoff Place, Chatsworth, CA 91311. (818) 886-5922. \$29.95

GRFX	S.M.	PLAY	DIFF	INTR	GAME
06	05	07	06	07	07

Rings of Zilfin

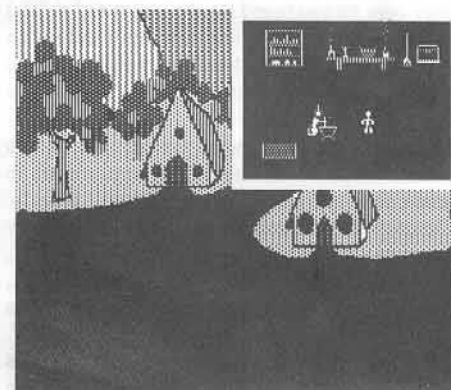

(Animated Adventure)

Compatibility: 48K Apple II, II+, IIe, IIgs, III

Requirements: One disk drive; second drive, Speedemon optional

"I, a fiend of darkness, will bring back the greed and hate and pain that makes a proper world. To achieve this exalted task I declare myself overlord of all I survey. ALL IS NOBLE DARKNESS!" Well, it's nice to know where you stand; and, in conquered Batinig, if one is not a minion of the evil Lord Dragos, one's prospects are all too grim. In SSI's *Rings of Zilfin* you are a simple youth marked by newly discovered magical abilities as the only one who might, some day, challenge the most powerful of necromancers.

Created long ago by well-meaning Zilfin wizard's, the twin Rings, when worn together, confirm supernatural power- just the thing for doing in an evil arch mage. One ring is lost somewhere in Batinig; which may be just as well, since the other is held by Dragos, who would like very much to have them both! While, sooner or later, you will have to secure the pair (hopefully for yourself), this proves a distant concern in what turns out to be a somewhat involved, very long-playing adventure.

The game's distinguishing feature- that which most obviously sets it apart from other fantasies- is the extent to which animation is employed, not just to add isolated touches of arcade pizzazz, but as a kind of glue which holds everything together. When traveling between towns (castles, etc.), you are shown as a walking figure against a scrolling backdrop. Along the way you can stop and pick valuable plants or, perhaps, garner information from passing monks. At night the sky darkens and you can make camp, though often you will have to unlimber your trusty bow to fight off attacks from the air. Swordplay or magic is the only way across demon-patrolled bridges or through clearings and other places guarded by other deadly adversaries. Castles, caves, towns, etc., all richly illustrated, offer even more varied encounters. Here you engage in trade to fatten your purse, buy weapons and supplies, sell gems won from monsters, dig for information, and obtain key items. Occasionally, you may have to dispatch fanatic followers of the dark path; but you will also meet personages vital

to your quest and have an opportunity to increase magic or sword skills.

Boasting attractive artwork, efficient save/restore, and good use of sound, *Rings of Zilfin* is a unique melding of arcade, picture-text, and map adventure forms, which plays much like a very lively, colorful, and involved version of each. Most entries are single-key commands; character development is important, and you need to keep an eye on such items as hit points and food supply. Good mapping is essential, as are notes covering everything from obscure clues through prices of trade goods- few games, in fact, are so demanding yet so much fun to play. Accompanied by clear, well-organized documentation, *Rings of Zilfin* is a genuine breakthrough in game design, definitely among the year's top entertainment values.

Available from: Strategic Simulations, 1046 N. Rengstorff Ave., Mountain View, CA 94043-1716. (415) 964-1353. \$39.95

GRFX	S.M.	PLAY	DIFF	INTR	GAME
08	07	07	07	08	09

Nine Princes in Amber



You plunge in after your companions. To your surprise, you see steps leading down through the crystal clear water. Beirdre is far ahead. Random following more slowly. Your head is soon covered by water. Next to you Random appears to be breathing normally. "It's death if I go and death if I stay," he says glumly, but continues making his way down the staircase. You hear the horsemen behind you.

(Picture/Text Adventure/Novel)

Compatibility: 64K Apple II series

Requirements: One disk drive; second drive optional

Granted, there is nothing especially bizaare about about waking up in a hospital room with a cast on your leg. But when you subsequently smash a hypo-wielding killer senseless with a single punch, rip off the cast, and walk out as good as new- well, that's a different matter. In Telarium's adventure game production of Roger Zelazny's first two "Amber" stories, you begin as the victim of an auto "accident" which jogs long dormant memories of an amazing personal history and of a place called "Amber".

A jewel of a city shining in medieval splendor, only Amber is real; other "realities" are but reflections or "shadows". As Corwin, a prince of Amber, you have many gifts (such as extraordinary strength); but most important is the ability to "walk through shadows"- in effect creating alternative realities. Your brothers and sisters, alas, are similarly gifted; and, with the throne vacant, all are engaged in a deadly, cutthroat competition for power. Now you will return to Amber and "walk the Pattern" to fully restore your memory and powers. Then, just

maybe, you can manage to sieze the throne for yourself!

Nine Princes in Amber is an attractive presentation offering good artwork, music, adequate save/restore, and elaborate prose. However, except for a clever little puzzle to challenge your pattern-walking savvy, the game is slavishly faithful to the original story line, hardly qualifying as an "adaptation" at all. That Telarium would bother to claim "...there are forty possible final endings" is as good a tipoff as any: this is a highly structured, low player initiative piece of gaming software. I've tried numerous deviations from the original line; and, so far, all have led quickly to unfavorable endings, usually fatal.

While there is some attempt to simulate the bargaining, making and breaking of alliances, and other wheeling-dealing (i.e. the real "meat" of the Amber series), anything remotely involved is beyond the program. More often than not, a non-committal "SHRUG" is sufficient to move things along in the right direction. With minimal parsing operating mainly as a page-turner, *Nine Princes* is one way to explore the world of Amber; a better approach is to read the books.

Available from: Available from Telarium: One Kendall Square, Cambridge, MA 02139. (617)-494-1200. \$39.95

GRFX	S.M.	PLAY	DIFF	INTR	GAME
07	07	06	06	05	05

Tass Times in Tonetown



You're in a small cavern, before a wall of cages containing wild, terrifying animals. To the west, a dimly lit tunnel heads into the blackness. [More]

(Adventure)

Compatibility: 64K Apple II series

Requirements: One disk drive; joystick, mouse optional

Like many amateur experimenters, Gramps has long been fascinated by such exotic phenomena as eloptic rays, time warps, and alternate dimensions. So, when you arrive for a visit only to find his lab humming and Gramps gone, only one conclusion is possible: somehow Gramps made his transdimensional hoop work! Concerned that he may be in trouble, you snatch up his pet dog Spot, head for the hoop, and leap to the rescue.

Tass Times transports you to a wierd, musically-oriented community called "Tonetown". Here guitar picks are the medium of exchange and you are well advised to spend

a few getting "tone" at local apparel vendors. Otherwise, you won't look "tass" (i.e. cool, hip, etc.) and may wind up just another vanished tourist. In such an odd setting you are too relieved to be mystified upon finding that Gramp's pet has emerged as Ennio, dogwonder, star reporter of the town's only newspaper, and an invaluable guide.

The plot thickens with the discovery that Gramps has been here, that he has vanished from Tonetown, and that he was last seen arguing with Mr. Franklin Snarl, a mean-tempered wheeler-dealer land developer, who happens to be a man-size snake with fangs! Just what IS going on at Snarl's estate? What is the wetlands mystery? How do the cute little "blobpets" figure in? And, as long as you're turning up more questions than answers, why not apply for a reporter's job with the "Tonetown Times"?!

Tass Times offers nicely done, animated artwork, good sound, and an interesting input option. Entries may be in text or you can move an on-screen cursor to point out items you wish to take or examine. Parsing is adequate, since no complicated manipulation of items is required; and an efficient multi-position save/restore option is a great aid when it comes to trying something risky. A solid, well-planned mystery with lots of curious places to explore, *Tass Times in Tonetown* is guaranteed to "tone up" your leisure hours.

Available from: Activision, P.O. Box 7286, Mountain View, CA 94039. (415) 960-0410. \$39.95

GRFX	S.M.	PLAY	DIFF	INTR	GAME
07	07	08	06	07	07

Auto Duel

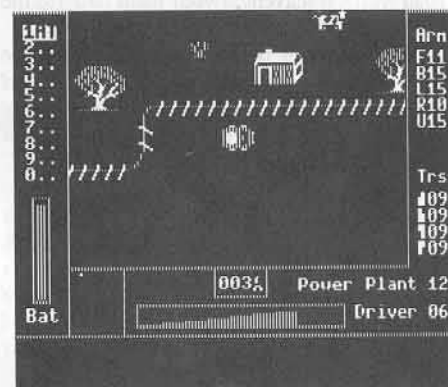

(Arcade Adventure)

Compatibility: 64K Apple II series

Requirements: One disk drive, joystick

It is the 21st century, a time when national governments have dissolved into a kind of controlled anarchy. Cities and the larger towns maintain order within their boundaries; but outside, along the vast, vital network of roads and super highways, only the strong survive, and right-of-way goes to the biggest gun! Marketed by Electronic Arts, Origin Systems' *Auto Duel* gives you a shot at fame, fortune,

and, just maybe, the chance to carve out a few legends.

Set in the Northeastern U.S. of 2030 A.D., the adventure embraces sixteen cities and a highway system spanning eight states and the District of Columbia. Unless continuing a saved game, you begin in New York, on foot, with \$2000. Your first priority is a decent set of wheels, but two grand will barely pay for an unarmed deathtrap. It will, however, take care of several days room and board, buy a suit of body armor, and cover practice fees at the local auto dueling arena. Here a quick check of the events schedule reveals that tonight is "amateur night" (what luck!); and you can risk your neck in an arena-supplied, one-gun "killer cart" for the \$1500 prize money. Thus begins your career as an auto duelist, with days spent traveling from city to city by bus and nights filled with deadly competition. Success brings prestige, boosts in "driving" and "marksmanship" skills, and money for the sort of machine you can take out on the road or enter in more advanced, higher payoff, dueling events.

As a full-scale adventure, *Auto Duel* incorporates much the same character / equipment development, buying and selling, and exploration elements one normally expects to find, plus a very strong arcade action emphasis. Except when moving around in a city, you view a combat-type display showing your car (and any others nearby) on smoothly scrolled scenery along with a small radar screen and indicators for weapons and armor status, speed, and mileage. While any single, primary goal is left for players to discover, an interesting feature is that the three occupations appear to be viable routes to different kinds of 'ultimate' success. As a duelist you can aim to win city championships, perhaps at all nine arena locations. As a courier you can graduate to mysterious "special assignments"; and as a road warrior/scavenger your main target is the elusive outlaw known only as "Mr. Big".

Supplied with detailed manual, reference card, and even a neat little toolkit, *Auto Duel* is innovative and attractive, but also seriously flawed. Resuming a saved game wipes out your saved character, only resaved via a "QUIT" (whereupon everything simply freezes)- so hours of progress can be lost to a power glitch or by getting killed (all too easy). Such 'rough edges' are annoying, but the real problem is with combat. Unresponsive controls, mediocre weapon effects graphics, and lackluster sound put a real damper on fun. Evidently, your low initial "driving skill" number CAUSES your car to handle like a boat- that is, a beginning driver must actually demonstrate more arcade ability than an experienced duelist to achieve the same result! Very promising and thus all the more disappointing, *Auto Duel* is hardly a wreck; but it isn't a 'performance machine' either.

Available from: Electronic Arts, 2755 Campus Drive, San Mateo, CA 94403. (415) 571-7171.

GRFX S.M. PLAY DIFF INTR GAME

07 08 05 08 06 06

Perry Mason

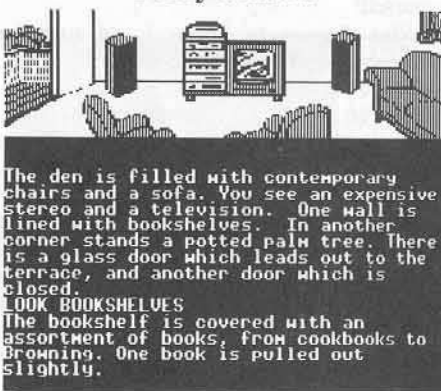

(Picture/Text Adventure)

Compatibility: 64K Apple II series

Requirements: One disk drive; second drive optional

When Perry Mason agrees to defend Laura Kapp, arrested for the murder of her restaurateur husband, Victor, there is really only one question. Since his client is obviously as pure as the driven snow, who did it? In Telarium's *Perry Mason: The Case of the Mandarin Murder* you take the role of the famed attorney, ably assisted by investigator Paul Drake and your secretary, Della Street. As usual, it looks like everything is stacked in the prosecution's favor; and if you can't nail the real murderer, little Laura could take the Big Fall!

In several respects an unusual sort of adventure, *Perry Mason* is arranged in two major phases: investigation and trial. (Just like the TV series.) Since poor Victor was found shot to death in the Kapp's swanky apartment (with an unconscious, gun-wielding Laura nearby), you begin with a room-by-room search for clues. Whether you follow Sargent Holcomb's admonition not to remove anything is your decision; but it's important to get a good look at everything now, since it may be your last chance. Probably, visiting your jailed client is a good idea; and you will definitely want to call on Drake's expertise and Della's talent for persuading hesitant witnesses.

One thing you don't lack is suspects. Besides the doorman, and a restaurant critic, there's an ex-business partner and Margot Duboq (Victor's mistress?), whom Drake describes as "a curvy little croissant"- among others. Remember, you haven't got all year to check out these characters. In this game the wheels of justice grind like a chainsaw; and before you know it, you're in court.

The coup de grace, one way or the other, is delivered in the courtroom. Here you may call, examine, and cross-examine witnesses, introduce evidence, and even engage in your justly famous theatrics. Paul and Della are still ready to help; but D.A. Hamilton Burger is a tough adversary, so don't be overly discouraged if things don't pan out the first few times you try the case. (Laura's the one who should be discouraged!)

Telarium has expended a good deal of effort to make its mystery/trial adventure both

playable and realistic. Parsing is entirely adequate, especially with accompanying word lists, a chart on "sentence building", and explicit descriptions of game courtroom procedures. Offering good art work, multi-place save/restore, and surprisingly detailed characters, *Perry Mason* is an innovative, challenging, and entertaining approach to long popular themes.

Available from: Telarium, One Kendall Square, Cambridge, MA 02139. (617)-494-1200. \$39.95

GRFX S.M. PLAY DIFF INTR GAME

07 08 07 08 08 08

Breakers

(Text Adventure/Novel)

Compatibility: 48K Apple II series

Requirements: One disk drive; second drive, 128K, 80-column card optional

Remember all those sci-fi flicks about kindly, peace-loving aliens getting kicked around by greedy, hard-hearted humans? Well, now you can REALLY start to feel sorry for the aliens because in Broderbund's 51st century *Breakers* scenario, that's just what you are. As to how a little golden-skinned "Lau" native of Borg comes to be marooned and in hiding on an aging colony station orbiting his home planet- that's easy. You and five of your pals came to this mining company-dominated rust bucket to lodge a complaint!

Set in an obscure corner of Slug Nubula, *Breakers* involves the often mysterious interplay of several groups and individuals active both on Borg and its man-made satellite, "Nimbus". First, there's United Mining Combine, which maintains a large (expensive) security force of brutal "gak" police on the station. This, though Borg has long been mined-out and no ore has been shipped for months. So why is a high-powered executive running the UMC operation; and just what is the company really after?- no one is saying much. On the other hand, swarms of punk rock hippie motorcycle outlaw types, called "breakers," hardly bother to conceal their own illicit enterprises. While one gang on the planet harvests "Magic" (a powerful narcotic employed by Lau shamen) and occasionally snatches a few natives; another gang on Nimbus handles distribution of the drug and makes some extra bread shipping the cute little Lau out to well-heeled socialites as fashionable pets!

Annoying, to be sure, yet such everyday atrocities pale to insignificance beside the actual reason for your people's protest. According to ancient Lau tradition, all life on Borg is periodically destroyed as the result of collision with Garbo, a mystical planetary twin which shares Borg's orbit. Only the Lau and any life forms near their enclave are saved, thanks to an elaborate ceremony centering around sacred "Elements" which must be gathered just prior to collision. Though no Terran instruments have ever detected Garbo, you know it exists and that the next meeting of the planets is scarcely days

have somehow interfered with the gathering process, perhaps unwittingly collecting the Elements themselves. Thus, the delegation to Nimbus and your own hazardous situation as the only Lau to escape being mugged upon arrival. All of the breakers aren't outlaws, and a visiting magazine reporter may help; but one thing is clear. Only a little time remains to locate the Elements and avert total disaster!

Supplied with a nicely illustrated, information-packed scene-setter novelette, *Breakers* certainly boasts one of the more labyrinthine of computer adventuring scenarios. Happily, the game is somewhat more open to player initiative, with better-developed players, improved parsing, and less ponderous prose than earlier "Electronic Novel" releases. You will still have to put up with excessive disk access and looking up key words for each game restore—a real pair of anti-features. *Breakers*, fortunately, is enough fun to be worth the bother.

Available from: Broderbund, 17 Paul Drive, San Rafael, CA 94903. (415) 479-1700. \$44.95

GRFX	S.M.	PLAY	DIFF	INTR	GAME
NA	09	05	06	08	07

Spellbreaker

(Text Adventure)

Compatibility: 48K Apple II series

Requirements: One disk drive; second drive optional

Having crunched the evil warlock Krill to win your wizard spurs, and junked Jecarr, the evil demon, to achieve leadership of the Circle of Enchanters, you are as ready as you'll ever be for the "final conflict between good and evil"! (promises, promises...) Once again a crisis has befallen the kingdom, as spells flop, rat ants run wild, and everywhere there is chaos and confusion. But it is at an emergency conclave of the Guild of Enchanters that the final blow of your mysterious adversary's opening moves is delivered. For scarcely have the masters concluded their litany of woes when the hall is suddenly filled with a host of jibbering newts, toads, and salamanders. Normally, such opportunistic showing off would incur an appropriate reprimand from the guildmasters. Unfortunately, except for yourself, these bleeping terrarium dropouts ARE the guildmasters!

As volume three of the Enchanter Saga, *Spellbreaker* continues a series tradition; that is, the game bears remarkably little resemblance to its predecessors. To be sure, some of the persona, such as your venerable mentor Belboz, are familiar; as are placename references (Flathead Mountains, etc.). You still begin with a few stock spells such as "Frotz" to make something give off light, and "Gnusto" to transfer spells from scrolls to your spell book. Too, spell scrolls remain among the more valuable items you can find. The differences, however, are striking. First, the game landscape is mostly broken up into many, very different, three to five-room pockets. The guildhall area,

a grue cave, and a volcano are examples. Transport among these pockets is effected via application of the "Blorple" spell on featureless white cubes. So blorpling one cube might take you to the "Air Room;" whereas blorpling another would zip you to the grue cave. There are many of these cubes to collect and (hint) a clever box that can help you tell one from another.

Pitting you against the most elusive of adversaries, *Spellbreaker* is certainly deserving of Infocom's "advanced level" rating. Vengeful idols, giant rocs, and sneezing ogres are just a few of the colorful characters you will encounter, each involved in one or another puzzle within puzzles. Parsing is necessarily very good; and, with fast, multi-position save/restore, testing solutions is a snap. Typically, the game is well supported with such goodies as an enchanter's guild pin, famous wizard trading cards, and a Magic Equipment Catalog chocked with great gift-giving ideas (e.g. "What can we say about the wonders of lizards that hasn't been said already?" ...so true). Logical, long-playing, and with a nice touch of humor, *Spellbreaker* is a worthy continuation of the best text adventure series ever published.

Available from: Infocom, 125 Cambridge Park Drive, Cambridge, MA 02140. (617) 492-1031.

GRFX	S.M.	PLAY	DIFF	INTR	GAME
NA	08	08	08	09	09

Murder on the Mississippi

(Adventure)

Compatibility: 64K Apple II series

Requirements: One disk drive

Everyone knows that when a famous detective takes a vacation there's sure to be a juicy murder. So when the renown British sleuth, Sir Charles Foxworth, and his faithful sidekick Regis board the "Delta Princess" for New Orleans, it's a sure bet that somebody's

ticket is going to be punched, permanently. In Activision's *Murder on the Mississippi* you are Sir Charles, challenged to discover the foul deed, gather evidence, and nail the culprit—all on shipboard. With only three days to New Orleans every minute counts; so you best get cracking!

Employing four-quadrant joystick controls for movement and a scrolling hi-res display, *Murder* merges an arcade look and feel with the deliberate pace and puzzle-busting emphasis of an adventure. You and Regis actually walk along the four decks of the "Delta Princess", move about inside cabins searching for clues, and may even direct a passenger or crewman to accompany you.

There turn out to be eight prime suspects including the straight-laced captain, an infamous judge, a flititious southern belle, and five others just as colorful. While gathering clues is essential; it is the collected statements of your suspects, especially about each other, which ultimately spell the evil-doer's doom—that is, if you are clever enough to see the pattern, but not too clever for your own good. Falling into a trap can have nasty consequences; and, of course, an unsubstantiated or mistaken accusation can get you tossed off the boat.

Murder on the Mississippi is a well thought-out adventure mystery just slightly burdened by sluggish controls. Since the only real puzzle is 'who done it', menu-driven search and questioning options are more than adequate. Game save/restore functions work well; and a nifty scheme for in-program, on-screen note-taking frees you from most paper and pencil work. The game is a bit slow to start; but once the clues start rolling in, this is one you'll have trouble turning loose.

Available from: Activision, P.O. Box 7286, Mountain View, CA 94039. (415) 960-0410.

GRFX	S.M.	PLAY	DIFF	INTR	GAME
07	06	07	06	07	07

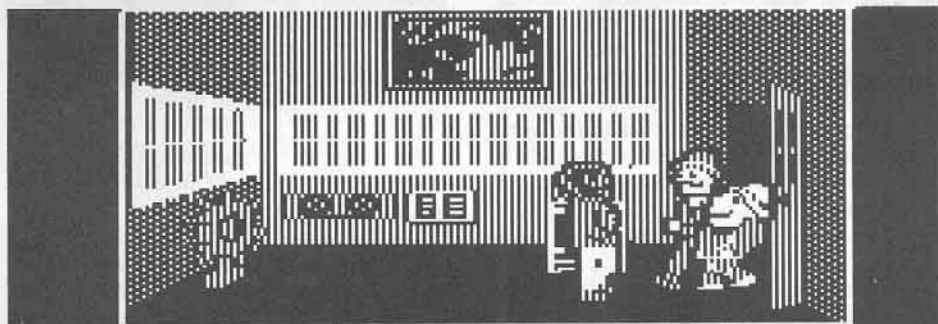

Capta in Overbight,

Tell me about...

What do you know about this evidence?

Please follow me...

Share notes with Capta in Overbight

Accuse Capta in Overbight

Previous menu

Alter Ego

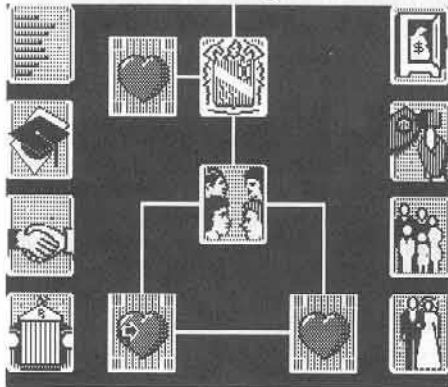

(Life Simulation/Adventure)

Compatibility: 64K Apple II series

Requirements: One disk drive; joystick optional

While most entertainment software transports the player to exotic settings and bazaar circumstances, a few packages traffic in the mundane, familiar world of everyday experience. One such is Activision's *Alter Ego*, a life simulation which invites you to play "what if". What if you were a more (or less) adventurous teenager? Suppose you had chosen a different career? or a different spouse? ...In *Alter Ego* your goal is to experience, grow, and be true to yourself-- whoever that may be!

Unless continuing from a saved position, you begin with a questionnaire to define a personality; or you may have the program create one at random. The resulting profile outlines tendencies in twelve areas (confidence, intelligence, social skills, etc.). Updated throughout the life of your character, the profile is the major factor in deciding which experiences are available and whether any responses are 'out of character' and thus rejected by the program.

Play may commence at any of seven life stages from birth and infancy through adolescence, adulthood, and old age. In each stage you seek out experiences by moving along the scrollable "life map" onto tokens representing various types of episodes. A heart, for instance, equates with emotionally charged situations; a man with ladder indicates work experiences, etc.. Unless a selected episode is too advanced for your current level of development, it will be presented along with response options. A brief discussion of results follows your choice and the profile is automatically updated. (You can check your progress at any time by 'clicking' the "status" token.) Every stage includes many non-replayable "life experiences" with repeatable "life choices" (those concerning dating, college, marriage, etc.) available as appropriate. Assuming you don't fall out of a window, get yourself shot, or otherwise push your luck too far, when you reach a given age-- ready or not-- it's onward to the next stage.

Offered in separate, three-diskette, male and female versions, *Alter Ego* is an attractive, smooth-running production; though not one entirely free of psychological glitches and

contradictions. I doubt, for instance, that any child has ever viewed a dog as a "hairy man". Nor does it seem correct to characterize a teenager's decision not to interfere in an armed holdup as "fearful", whereas intervention is labeled "brave". (How about "reasonable" vs. "stupid"?) Why does the personality questionnaire ask if the player is going to respond truthfully?-- you couldn't generate much of an "alter" ego if you did-- and why is the player warned beforehand of sexually explicit episodes but not violent, life-threatening ones? Perhaps players should simply be warned that, while some of the episodes are interesting, even a bit spicy, most are roughly as stimulating as a "Father Knows Best" rerun, and just as predictable. The minor variations on everyday experience allowed in this ultra-mundane simulation could be instructive in a classroom setting; but, as entertainment, the appeal is strictly to those for whom the best fantasy is the least fantasy.

Available from: Activision, P.O. Box 7286, Mountain View, CA 94039. (415) 960-0410. \$49.95 (specify Male or Female version).

GRFX	S.M.	PLAY	DIFF	INTR	GAME/ED
07	07	08	04	05	05/07

Shard of Spring

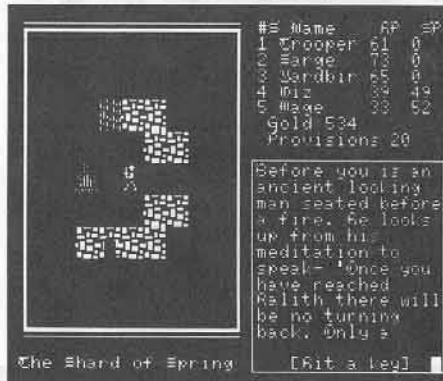

(Map-Maze Adventure)

Compatibility: 64K Apple II series

Requirements: One disk drive

For centuries the enchanted shard, a piece of the long lost Life Stone, maintained a climate of eternal spring on the island of Ymros. Indeed, it continues to do so; but now at a heavy cost. For the evil sorceress Siriadne has seized the magical sliver; and, with the threat of the shard's destruction, she extorts ruinous tribute from the people of Ymros. Years of poverty and roving gangs of the sorceress' monster minions have gradually crushed all thought of resistance. Well, almost all. Even now a few brave young warriors and journeyman wizards have gathered, determined to recover the shard and put an end to Siriadne's tyranny!

SSI's *Shard of Spring* is an *Ultima / Questron*-type adventure highlighting tactical combat, dungeon exploration, and character development. An active party may have up to five members, each of whom is either a warrior

or a wizard. The primary measure of character growth is "level." Boosts in level increase base hit or base spell points, besides allowing acquisition of new skills. For warriors, the latter includes weapons use skills, armored skin, and karate, among others. Wizards, on the other hand, may obtain access to whole new spell groups and areas of knowledge with skills such as "Fire Runes", "Wind Runes", "Potion Lore", and "Monster Lore". As in *Bard's Tale*, a character's level depends upon experience points, but advancement is granted only at warrior or wizard guilds located in just a few towns.

Traveling cross-country or moving in a dungeon, your party is represented by a warrior figure inside a 9x9 scrolling map insert. Whereas towns provide the expected supply, healing, rumor mill, and R&R services, dungeons supply certain key items and information not otherwise obtainable. Also, only in a dungeon or the countryside can you encounter monsters, your source of gold and experience points. Encounters lead to combat, whereupon the display shifts to a closeup showing individual party members and monsters. Whether snake, orc, skeleton, evil mage, etc., each monster has attributes which determine its mobility, toughness, and offensive capabilities; and each is rated according to level. Since combat is about as flexible and easy to manage as one might hope and there's no time pressure, effective maneuvering takes surprisingly little practice. (And, if things look really bad, you can always run for an exit.)

Offering the best tactical combat of any major adventure, *Shard of Spring* also delivers a very fine magic system replete with variously potent spells for attack, defense, healing, information, and transportation. Production values are a bit weak, as evidenced in sub-state-of-the-art hires text and such glitches as mislabeling the total gold won in a combat as each player's share. While the manual is well organized and has an attractive cover, it is grossly incomplete. There is no specific information relating to monsters and nothing is said about being able to walk through some dungeon walls. Still, such miscues are merely bothersome alongside a major problem with pacing. Basically, a player runs out of new things to do, new places to go, etc. long before achieving the experience points required to wrap things up and win. So, after many enjoyable hours of play, either you spend many additional hours wearing ruts in the maps looking for fights, or you declare yourself "winner" and quit. Hopefully, SSI will seriously consider making the necessary revisions. For now, if too much combat is never enough for you, this is your game.

Available from: Strategic Simulations, 1046 N. Rengstorff Ave., Mountain View, CA 94043-1716. (415) 964-1353. \$39.95

GRFX	S.M.	PLAY	DIFF	INTR	GAME
07	06	07	07	08	06



Inferno

by Charles S. Taylor

Inferno
The Software Emporium
P. O. Box 3232
Tulsa, OK 74101

Requirements:
Super IOB v1.5
Blank disk
Inferno program

Inferno is a run-of-the-mill text adventure game that is probably not on anyone's hit list, but the general procedure may interest some of the newcomers to softkeying. The technique used here will break a surprising number of disks. The first step I take to break a disk is to use the nibble editor of COPY II Plus. This utility will find sector 0 of any track and display the address prologue. On normally formatted disks the address prologue is D5 AA 96. After the address prologue, there is usually eight intervening bytes and then the address epilogue (normally DE AA EB). Then comes a secondary "gap" (normally several FFs,) and a data prologue (normally D5 AA AD.)

In a similar manner, there is also a data prologue and epilogue. In order to write one sector (256 bytes) of data to a 16 sector disk, it is necessary to use 342 bytes of code between the data prologue and data epilogue. After identifying the address prologue, address epilogue, and data prologue, the next task is to find the data epilogue (normally DE AA EB) Copy II Plus facilitates this by displaying a memory address for the cursor location. By placing the cursor on the byte immediately following the data prologue, and adding \$156 (342 decimal = 156 hex) to the number displayed you can locate the data epilogue.

Move the cursor to the number obtained by adding \$156 to the display. The data epilogue is the next three bytes. This task is much easier if you have a calculator that can perform hexadecimal calculations. (I use a Sharp EL-506P calculator, available for less than

\$20.) Try this on a normal disk a few times. It's easier than it sounds.

Once you have identified these prologues and epilogues (or marks as they are sometimes known) you can use a utility program such as Super IOB and the Controller writer to copy the program to a normally formatted disk. The epilogues are represented by only the first two bytes when writing a controller for Super IOB, but sometimes the EB of the DE AA EB is handy in locating the data epilogue. On some protected disks, you will be able to find the data epilogue, but it will be more than \$156 bytes from the prologue. The above technique will not work on such a disk.

After copying the disk to a normally formatted disk, you have won half the battle. If you can catalog your new copy, many times you can determine the boot-up program, copy DOS from the system master, change the boot-up program with Copy II Plus and you're through. Before copying DOS to your new copy, be sure to use the Track-Sector Map utility from Copy II Plus to determine if there are files on track \$02. If there are, try copying the files to a formatted disk.

Inferno did not have a normal catalog, so the next thing was to search the disk for any references to the abnormal epilogues of DA AA. The easiest way to do this was to search the disk for occurrences of DA, then to look at the code surrounding the DA. I found LDA #SDA on track 0, sector 2, followed by a LDA #SAA a few lines later. On track 0, sector 3, I found CMP #SDA twice, followed by CMP #SAA. After editing the DA's to DE's I had a working copy.

Summary

1) Using Super IOB with the controller listed below, copy Inferno to a normally formatted disk. Super IOB will also make the following sector edits:

Track	Sector	Byte	from	to
\$00	\$02	\$9E	\$DA	\$DE
\$00	\$03	\$35	\$DA	\$DE
\$00	\$03	\$91	\$DA	\$DE

Note about Tarturian

Highland Computer Services
14422 S.E. 132nd
Renton, WA 98055

While using the nibble editor of COPY II Plus on Tarturian, I noticed that that data field was very long. I soon realized that Tarturian was a 13-sector format disk. Thirteen sector disks require 410 bytes to write a sector of data. Since I had just received COMPUTIST 32, I decided to try a shortcut and copy Tarturian by the method of Dave Stanton. He had written an all-purpose controller for protected 13 sector disks. I was rewarded for my laziness with a working, deprotected version of Tarturian.

1) Type in the Hartley controller B on page 23 of COMPUTIST #32, and follow the rest of that softkey.

Inferno controller

```
1000 REM INFERNO
1010 TK = 0 : LT = 35 : ST = 15 : LS = 15 : CD = WR
      : FAST = 1
1020 RESTORE : GOSUB 190 : GOSUB 210 : GOSUB
      170 : GOSUB 490 : GOSUB 610
1025 IF TK = 0 THEN TK = 7 : GOSUB 310 : TK = 0
1030 GOSUB 230 : GOSUB 490 : GOSUB 610 : IF
      PEEK (TRK) = LT THEN 1050
1040 TK = PEEK (TRK) : ST = PEEK (SCT) : GOTO
      1020
1050 HOME : PRINT "COPYDONE" : END
5000 DATA 213 , 170 , 150 , 213 , 170 , 173 , 218
      , 170 , 218 , 170
5010 DATA 3^ CHANGES
5020 DATA 0 , 2 , 158 , 222
5030 DATA 0 , 3 , 53 , 222
5040 DATA 0 , 3 , 145 , 222
```

controller checksums

1000	- \$356B	1050	- \$B21C
1010	- \$2544	5000	- \$6447
1020	- \$196E	5010	- \$15AC
1025	- \$7AAE	5020	- \$0BDE
1030	- \$4F37	5030	- \$C561
1040	- \$1A5D	5040	- \$FD48

Frogger

by M. M. McFadden

Sierra On-Line, Inc.
36575 Mudge Ranch Road
Coarsegold, CA 93614

Requirements:

Computer that can boot Frogger
Super Saver ROM

"...Good morning Mr. Phelps. The disk you are looking at is Frogger, whose copy protection scheme has prevented it from working with some disk drives. Conventional nibble copying techniques have been unable to copy it successfully. Your mission, should you decide to accept it, is to defeat the copy protection, making the game playable by everyone. This recording will self-destruct in five seconds. Good luck, Jim."

Boom.

One day, a friend of mine told me that his version of Frogger refused to work with his disk drive. I tried booting the disk on my system, and saw the following:

```
SPRIADISC (TM) SYSTEM (C) 1982 BITWORKS
```

The drive head then made a peculiar sliding sound across the disk, and finally the title page came on. I knew from previous experience that the sliding sound was associated with a copy protection scheme known as "spiraling" or "track arcing," which uses a mixture of quarter-tracking and synchronization that is almost uncopyable.

With nibble copying impossible, the next thing to try was boot code tracing. After a few minutes, I realized that it would be an exercise in futility. Someone did one heck of a nice job writing confusing code. This left only one option.

When Frogger boots, the entire game is loaded into memory, and never needs to access the disk again (except to load the title screen after each game). This means that we can make the game into a standard DOS 3.3 binary file without too much difficulty.

A memory map for Frogger looks like this (all numbers in hex):

\$0000-02FF: zero page, stack, input buffer
(unused by Frogger)

\$0300-03FF: hi-res character generator (HRCG)

\$0400-07FF: character set for the HRCG

\$0800-1FFF: unused

\$2000-3FFF: hi-res page 1 (not used until game begins)

\$4000-BFFF: main code for Frogger with a few, small open spaces

This memory map shows several problems. First, the hi-res character set resides on the text page. It will have to be moved, and the HRCG modified accordingly. Second, the code from \$9600-\$BFFF will have to be moved, since that is where DOS normally resides. Fortunately, the folks at Sierra On-Line have left a rather large open space from \$800-\$3FFF. Here's the battle plan: move \$9600-\$BFFF out of harm's way to \$1600-\$3FFF, and then move the HRCG and character set from \$0400-\$07FF to \$1100-\$15FF. This leaves a space at \$1000 where we can put a nice title page and the routines which will relocate the code.

With Super Saver ROM active, boot Frogger. Press Reset and then a colon to save the lower memory (from \$0000-08FF) at \$2000-2BFF. Now, we'll make a few quick modifications.

I said before that the code was extremely confusing. For example, look at the listing of \$B400 (listing #1). I would have had a rather difficult time decoding this, except that I came across it once before in Maze Craze Construction Set. Our first modification will be to deactivate the Frogger DOS routines with \$B41B:20 2F FB, so that instead of loading the title page, it will instead show the text page. Our next problem is the hires character set, which was moved from text page one to \$2400 by the Super Saver ROM. We would like to put it at \$1200, so modify the HRCG to recognize this new location with \$2347:12.

Since we will not be loading the title screen, there won't be any instruction regarding what key to hit to start the game. So at \$1000, we'll enter a short routine that will:

- a) Relocate all of the code that we have moved, and
- b) Show the keys to hit to start the game. The code is listing #2.

All we have to do now is move some code around, boot up a slave disk, and BSAVE it.

Step by Step

- 1) Initialize a new disk, and delete the Hello program.

```
INIT HELLO  
DELETE HELLO
```

- 2) Remove the blank, insert Frogger, and boot it.

PR#6

- 3) When the menu appears, hit Reset and a colon (:).

- 4) Make some modifications.

```
B41B:20 2F FB  
2347:12
```

5) Move the volatile stuff to their new locations.

1100<2300.27FFM
1600<9600.BFFFM

6) Put the slave disk in the drive, and boot it.

6Ⓟ

7) Enter the menu at \$1000 (see the hexdump, listing #3)

8) DOS normally doesn't allow you to save a program that is larger than \$7FFF bytes. Fix this with:

A9964:FF

9) Save the game

BSAVE FROGGER, A\$1000, L\$8600

10) Try it!

1000G

Normally you would hit the space bar, the title page would appear, and you would then hit <SB>, J, or D. So, immediately after you BRUN FROGGER, hit the space bar. It will try to load the title page, and then wait for another keypress. Sorry for the inconvenience.

Well, that's it. An extremely complex copy protection scheme shot down in flames by changing four bytes. I guess they'll never learn. Bye. *** MISSION ACCOMPLISHED ***

Listing #1 \$B400

```

B400: PHP
B401: BMI $B404 note how it branches to
B403: JMP $0100 middle of this statement
B406: JMP $488A
B409: TYA
B40A: PHA
B40B: LDX #$1F
B40D: LDA $00,X
B40F: STA $B4C0,X
B412: DEX
B413: BPL $B40D
B415: JSR $B468 exclusive-ors the code
B418: LDA $A007 at $BB00, which has
B41B: JSR $BB00 hidden disk routines
B41E: JSR $B468 it is exclusive-ored
B421: LDX #$1F again, re-hiding it
B423: LDA $B4C0,X
B426: STA $00,X
B428: DEX
B429: BPL $B423

```

Listing #2 Frogger menu listing

```

1000: LDY #00
1002: LDA $1600,Y move $1600-3FFF
1005: STA $9600,Y to $9600
1008: INY
1009: BNE $1002
100B: INC $1004
100E: INC $1007
1011: LDA $1007
1014: CMP #00
1016: BNE $1002
1018: LDA $1100,Y move $1100-11FF
101B: STA $0300,Y to $300

```

```

101E: INY
101F: BNE $1018
1021: JSR $FC58 clear the screen
1024: LDA $1038,Y print the menu
1027: BEQ $102F
1029: JSR $FDF0
102C: INY
102D: BNE $1024
102F: JMP $4003 Start Frogger

```

Listing #3 Menu Hexdump

```

1000: A0 00 B9 00 16 99 00 96 $8A50
1008: C8 D0 F7 EE 04 10 EE 07 $6F35
1010: 10 AD 07 10 C9 C0 D0 EA $598A
1018: B9 00 11 99 00 03 C8 D0 $1B6D
1020: F7 20 58 FC B9 38 10 F0 $6CE3
1028: 06 20 F0 FD C8 D0 F5 4C $2626
1030: 03 40 00 00 00 00 00 00 $1737
1038: 8D 8D 8D 8D 8D A0 A0 A0 $8B68
1040: A0 A0 A0 A0 A0 A0 A0 A0 $7BE8
1048: A0 A0 C6 A0 D2 A0 CF A0 $ECC9

1050: C7 A0 C7 A0 C5 A0 D2 8D $ACAA
1058: 8D 8D A0 A0 A0 A0 A0 A0 $C8B8F
1060: A0 A0 D3 D0 C1 C3 C5 A0 $8DB7
1068: C2 C1 D2 A0 BD A0 D5 D3 $89FE
1070: C5 A0 CB C5 D9 C2 CF C1 $C98D
1078: D2 C4 8D 8D A0 A0 A0 A0 $DDDD0
1080: A0 A0 A0 A0 A0 A0 A0 A0 $CDD0
1088: A0 A0 A0 A0 CA A0 BD A0 $5865
1090: D5 D3 C5 A0 CA CF D9 D3 $925F
1098: D4 C9 C3 CB 8D 8D A0 A0 $76AE

```

```

10A0: A0 A0 A0 A0 A0 A0 A0 A0 $164E
10A8: A0 A0 A0 A0 A0 A0 C4 A0 $8CCA
10B0: BD A0 C4 C5 C6 C9 CE C5 $65EF
10B8: A0 CB C5 D9 D3 00 $8C58

```

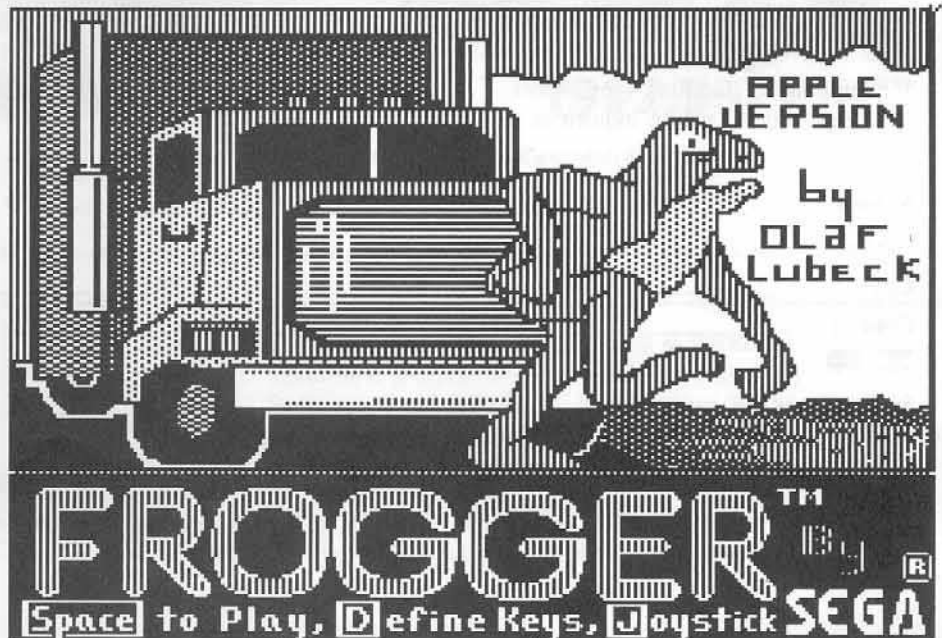

S.O.S.

(Save On Software)

Title	Publisher	Price	Qty	Total Cost
<i>Recommended Literature:</i>				
<input type="checkbox"/> Beneath Apple DOS (Book)	Quality Software	\$16.00	_____	_____
<input type="checkbox"/> Beneath Apple ProDOS (Book)	Quality Software	\$16.00	_____	_____
<i>Recommended Software:</i>				
<input type="checkbox"/> Global Program Line Editor	Beagle Bros	\$35.25	_____	_____
<input type="checkbox"/> Magic Window // (specify // or //e)	Artsci	\$106.00	_____	_____
<input type="checkbox"/> Bag of Tricks II	Quality Software	\$39.75	_____	_____
<i>Miscellaneous Bargains</i>				
<input type="checkbox"/> Amazon	Spinnaker Software	\$12.75	_____	_____
<input type="checkbox"/> Beyond Castle Wolfenstein	Muse Software	\$24.50	_____	_____
<input type="checkbox"/> Borrowed Time	Activision, Inc	\$32.00	_____	_____
<input type="checkbox"/> Computer Prep for SAT	Harcourt, Brace	\$32.00	_____	_____
<input type="checkbox"/> Ghostbusters	Activision, Inc	\$32.00	_____	_____
<input type="checkbox"/> Great American Road Race	Activision, Inc	\$32.00	_____	_____
<input type="checkbox"/> Homeword Word Processor & Speller (128K)	Sierra On-Line	\$55.50	_____	_____
<input type="checkbox"/> Mychess II	Datamost	\$13.00	_____	_____
<input type="checkbox"/> Silent Service	Microprose	\$27.75	_____	_____
<input type="checkbox"/> Speed Reader II	Davidson & Assoc.	\$49.50	_____	_____
<input type="checkbox"/> Story Maker	Scholastic	\$32.00	_____	_____
<input type="checkbox"/> Swashbuckler	Datamost	\$15.00	_____	_____
<input type="checkbox"/> The Newsroom	Springboard	\$47.75	_____	_____
<input type="checkbox"/> Winter Games	EPYX	\$32.00	_____	_____
<input type="checkbox"/> Wizardry	Sir-Tech	\$39.75	_____	_____

***Shipping & Handling (per order)

\$3.00

*Foreign orders, please inquire as to correct shipping fees.

Total _____

Name _____ ID# _____

Address _____

City _____ State _____ Zip _____

Country _____ Phone _____

Signature _____ Exp. _____

CP41

To order, complete order form and mail to:
COMPUTIST PO Box 110937-SOS Tacoma, WA 98411

Offer good while supplies last. Washington residents add 7.8% sales tax. Foreign orders inquire as to appropriate shipping and handling fees. Limited offer, expires April 30, 1987.

Graphics from Spinnaker Software's 'Amazon'

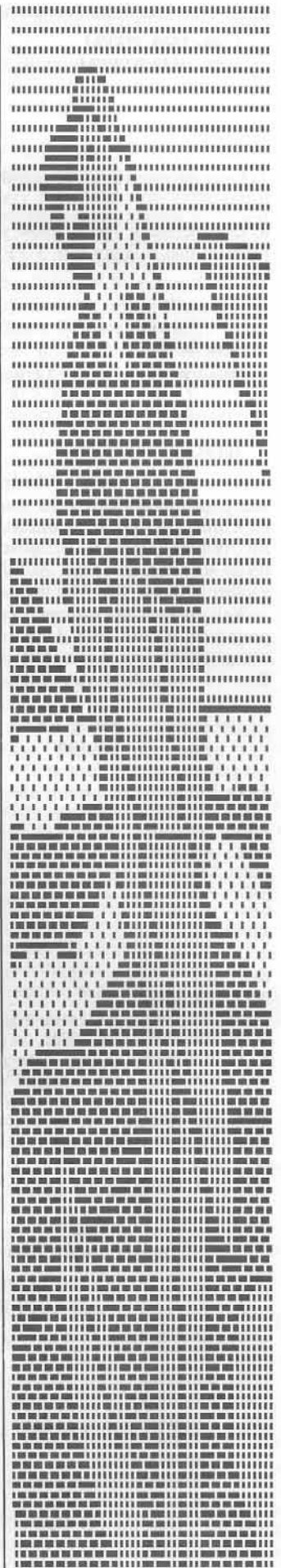

The Book Of Softkeys

Volumes I and II

Legends tell of the days when the ancient back issues of Hardcore COMPUTIST were readily available to anyone who wished to purchase them. Those days may be long since past, but the information contained in these ancient documents has been diligently transcribed to the pages of a modern reference work: The Book Of Softkeys.

From deep within the COMPUTIST archives comes a collection of softkeys originally contained in issues 1 through 5 and 6 through 10 (B.O.S. Volumes I and II respectively). The two volumes also contain some of the more useful programs and tutorials presented in those early issues. The books make an economical alternative to those rare (and unavailable) back issues of Hardcore COMPUTIST.

Volume I: Issues 1-5

(\$12.95)

contains softkeys for: Akalabeth | Ampermagic | Apple Galaxian | Aztec | Bag of Tricks | Bill Budge's Trilogy | Buzzard Bait | Cannonball Blitz | Casino | Data Reporter | Deadline | Disk Organizer II | Egbert II Communications Disk | Hard Hat Mack | Home Accountant | Homeward | Lancaster | Magic Window II | Multi-disk Catalog | Multiplan | Pest Patrol | Prisoner II | Sammy Lightfoot | Screen Writer II | Sneakers | Spy's Demise | Starcross | Suspended | Ultima II | Visifile | Visiplot | Visitrend | Witness | Wizardry | Zork I | Zork II | Zork III | **PLUS** how-to articles and program listings of need-to-have programs used to make unprotected backups.

Volume II: Issues 6-10

(\$17.95)

contains softkeys for: Apple Cider Spider | Apple Logo | Arcade Machine | The Artist | Bank Street Writer | Cannonball Blitz | Canyon Climber | Caverns of Freitag | Crush, Crumble & Chomp | Data Factory 5.0 | DB Master | The Dic'tion*ary | Essential Data Duplicator I & III | Gold Rush | Krell Logo | Legacy of Llylgamyn | Mask Of The Sun | Minit Man | Mouskattack | Music Construction Set | Oil's Well | Pandora's Box | Robotron | Sammy Lightfoot | Screenwriter II v2.2 | Sensible Speller 4.0, 4.0c, 4.1c | the Spy Strikes Back | Time Zone v1.1 | Visible Computer: 6502 | Visidex | Visiterm | Zaxxon | Hayden Software | Sierra Online Software | **PLUS** the complete listing of the ultimate cracking program...Super IOB 1.5 | **and more!**

Name _____ ID# _____

Address _____

City _____ State _____ Zip _____

Country _____ Phone _____

  _____ Exp. _____

Signature _____ CP41

- Volume I \$12.95 + \$2 shipping & handling
- Volume II \$17.95 + \$2 shipping & handling
- Both volumes! \$25.90 + \$3 shipping & handling

Foreign orders (except Canada & Mexico), please add \$5.00 per book shipping & handling. U.S. funds drawn on U.S. banks only. Most orders shipped within 5 working days, however please allow 4-6 weeks delivery for some orders. Washington State orders add 7.8% sales tax.

Send your orders to:

COMPUTIST
PO Box 110846-T
Tacoma, WA 98411



Are you missing a piece of the picture ???!!!

Issue	Mag \$4.75	Disk \$9.95	Both \$12.95
41	<input type="checkbox"/>	<input type="checkbox"/>	<input type="checkbox"/>
40	<input type="checkbox"/>	<input type="checkbox"/>	<input type="checkbox"/>
39	<input type="checkbox"/>	<input type="checkbox"/>	<input type="checkbox"/>
38	<input type="checkbox"/>	<input type="checkbox"/>	<input type="checkbox"/>
37	<input type="checkbox"/>	<input type="checkbox"/>	<input type="checkbox"/>
36	<input type="checkbox"/>	<input type="checkbox"/>	<input type="checkbox"/>
35	<input type="checkbox"/>	<input type="checkbox"/>	<input type="checkbox"/>
34	<input type="checkbox"/>	<input type="checkbox"/>	<input type="checkbox"/>
33	<input type="checkbox"/>	<input type="checkbox"/>	<input type="checkbox"/>
32	<input type="checkbox"/>	<input type="checkbox"/>	<input type="checkbox"/>
31	<input type="checkbox"/>	<input type="checkbox"/>	<input type="checkbox"/>
30	<input type="checkbox"/>	<input type="checkbox"/>	<input type="checkbox"/>
29	<input type="checkbox"/>	<input type="checkbox"/>	<input type="checkbox"/>
28	<input type="checkbox"/>	<input type="checkbox"/>	<input type="checkbox"/>
27	<input type="checkbox"/>	<input type="checkbox"/>	<input type="checkbox"/>
26	<input type="checkbox"/>	<input type="checkbox"/>	<input type="checkbox"/>
25	<input type="checkbox"/>	<input type="checkbox"/>	<input type="checkbox"/>
24	<input type="checkbox"/>	<input type="checkbox"/>	<input type="checkbox"/>
23	<input checked="" type="checkbox"/>	<input type="checkbox"/>	<input checked="" type="checkbox"/>
22	<input type="checkbox"/>	<input type="checkbox"/>	<input type="checkbox"/>
21	<input checked="" type="checkbox"/>	<input type="checkbox"/>	<input checked="" type="checkbox"/>
20	<input type="checkbox"/>	<input type="checkbox"/>	<input type="checkbox"/>
19	<input type="checkbox"/>	<input type="checkbox"/>	<input type="checkbox"/>
18	<input checked="" type="checkbox"/>	<input type="checkbox"/>	<input checked="" type="checkbox"/>
☆ 17	<input type="checkbox"/>	<input type="checkbox"/>	<input type="checkbox"/>
16	<input type="checkbox"/>	<input type="checkbox"/>	<input type="checkbox"/>
..... Book of Softkeys Vol 3			
15	<input checked="" type="checkbox"/>	<input type="checkbox"/>	<input checked="" type="checkbox"/>
14	<input checked="" type="checkbox"/>	<input type="checkbox"/>	<input checked="" type="checkbox"/>
13	<input checked="" type="checkbox"/>	<input type="checkbox"/>	<input checked="" type="checkbox"/>
12	<input checked="" type="checkbox"/>	<input type="checkbox"/>	<input checked="" type="checkbox"/>
11	<input checked="" type="checkbox"/>	<input type="checkbox"/>	<input checked="" type="checkbox"/>
..... Book of Softkeys Vol 2			
10	<input checked="" type="checkbox"/>	<input type="checkbox"/>	<input checked="" type="checkbox"/>
9	<input checked="" type="checkbox"/>	<input type="checkbox"/>	<input checked="" type="checkbox"/>
8	<input checked="" type="checkbox"/>	<input type="checkbox"/>	<input checked="" type="checkbox"/>
☆ 7	<input type="checkbox"/>	<input type="checkbox"/>	<input type="checkbox"/>
6	<input checked="" type="checkbox"/>	<input type="checkbox"/>	<input checked="" type="checkbox"/>
..... Book of Softkeys Vol 1			
☆ 4	<input type="checkbox"/>	<input type="checkbox"/>	<input type="checkbox"/>
3	<input checked="" type="checkbox"/>	<input type="checkbox"/>	<input checked="" type="checkbox"/>
Core 2	<input type="checkbox"/>	<input type="checkbox"/>	<input type="checkbox"/>
2	<input checked="" type="checkbox"/>	<input type="checkbox"/>	<input checked="" type="checkbox"/>
1	<input type="checkbox"/>	<input type="checkbox"/>	<input type="checkbox"/>
Core 1	<input type="checkbox"/>	<input type="checkbox"/>	<input type="checkbox"/>
Core 3	<input type="checkbox"/>	<input type="checkbox"/>	<input type="checkbox"/>
Computing 3	<input type="checkbox"/>	<input checked="" type="checkbox"/>	<input checked="" type="checkbox"/>
Best of Hardcore Computing	<input checked="" type="checkbox"/>	<input type="checkbox"/>	<input checked="" type="checkbox"/>
Core Special \$10.00	<input type="checkbox"/>		
(All three CORE magazines)			

Some disks apply to more than one issue and are shown as taller boxes. Special "Both" disk & magazine combination orders apply to one issue and its corresponding disk.

Book Of Softkey titles are inserted for reader information only. Each book contains all of the softkeys appearing in the issues below the title line. Please consult current Book of Softkey ad for current prices and ordering information.

- ☆ We have a limited supply of these issues.
- Back issue is no longer available

COMPUTIST back issues and library disks are frequently referenced in current issues.

Some back issues are no longer available, but library disks can still be purchased for all back issues.

What is a library disk?

A library disk is a diskette that contains programs that would normally have to be entered by the user. Documentation for each library disk can be found in the corresponding issue.

Rates For Foreign Orders

- Canada and Mexico rates are identical to U.S. First Class unless otherwise specified.
- Other Foreign Back Issue Rates: \$12.25 each. (includes shipping)
- Other Foreign Library Disk rates: \$11.94 each. (includes shipping). Special "Both" disk and magazine combinations shown do NOT apply to Foreign orders.

Send me the back issues and/or library disks indicated:

Name _____ ID# _____
 Address _____
 City _____ State _____ Zip _____
 Country _____ Phone _____
 _____ Exp. _____
 Signature _____ CP41

Send check or money order to: COMPUTIST PO Box 110846-T Tacoma, WA 98411.
 Most orders are shipped within 5 working days, however please allow 4-6 weeks delivery for some orders. Most orders shipped UPS so please use street address. Offer good while supply lasts. In Washington state, add 7.8% sales tax. **U.S. funds drawn on U.S. bank only.**

Limited Stock Back Issues!

17 Softkeys | The Print Shop | Crossword Magic | The Standing Stones | Beer Run | Skyfox | and Random House Disks | Features | A Tutorial For Disk Inspection and the Use Of Super IOB | S-C Macro Assembler Directives (reprint) Core | The Graphic Grabber For The Print Shop | The Lone Catalog Arranger Part Two |

7 Softkeys | Zaxxon | Mask of the Sun | Crush Crumble & Chomp | Snake Byte | DB Master | & Mouskattack | Features | Making Liberated Backups That Retain Their Copy Protection | S-C Assembler: Review | Disk Directory Designer | Core | COREfiler: Part 1 | Upper & Lower Case Output for Zork.....

4 Ultima II Character Editor | Softkeys | Ultima II | Witness | Prisoner II | Pest Patrol | Adventure Tips for Ultima II & III | Copy II Plus PARMS Update.....

Description of Available Back Issues.

40 *Softkeys* | Adventure Writer | Mychess II | Raster Blaster | *Readers' Softkeys* | Cranston Manor | Ghostbusters | Designer's Pencil | E-Z Learner | The American Challenge | Crime Wave | Encyclopedia Britannica Programs | *Features* | Taking the Wiz out of Wizardry | Adding a Printer Card Driver to Newsroom | *Core* | The Games of 1986 |

39 *Softkeys* | MIDI/8 Plus | Homeword v2.1 | Borrowed Time | Amazon | Speed Reader II | *Readers' Softkeys* | Discovery! | M-ss-ng L-nks series | Donald Ducks's Playground | Mastering the SAT | Copy II Plus 4.4C | Master of the Lamps | One on One | Bridge Baron | A.E. | Great American Cross-Country Road Race | Computer Preparation for the SAT | Castle Wolfenstein | Luscher Profile | Skyfox | Silent Service | Echo Plus | Swashbuckler | Randamn | *Features* | Electronic Disk Drive Swapper | Abusing the Epilogues | Print Shop Companion's Driver Game | *Core* | Keyboard Repair | Fixing the Applesoft Sample Disk | *Hints* | Carmen Sandiego |

38 *Softkeys* | CycloD | Alternate Reality | Boulder Dash I & II | Hard Hat Mack (Revisited) | The Other Side | *Readers' Softkeys* | F-15 Strike Eagle | Championship Lode Runner | Gato V 1.3 | I, Damiano | Wilderness | Golf's Best | *Features* | The Enhanced/Unenhanced II | Looking into Flight Simulator's DOS | *Core* | Appavarex | Installing a RAM disk into DOS 3.3 |

37 *Softkeys* | Under Fire | Pegasus II | Take 1 (revisited) | Flight Simulator II v1.05 (part 2) | *Readers' Softkeys* | Magic Slate | Alter Ego | Rendezvous | Quicken | Story Tree | Assembly Language Tutor | Avalon Hill games | Dark Crystal | *Features* | Playing Karateka on a //c | Track Finder | Sylk to Dif | *Core* | Breaking In: tips for beginners | Copy II Plus 6.0: a review | The DOS Alterer |

36 *Softkeys* | Flight Simulator II v 1.05 | AutoDuel | *Readers' Softkeys* | Critical Reading | Troll's Tale | Robot War | General Manager | Plasmania | Telarium Software | Kidwriter v1.0 | Color Me | *Features* | ScreenWriter meets Flashcard | The Bus Monitor | Mousepaint for non-Apples | *Core* | The Bard's Dressing Room | *Advanced Playing Techniques* | Championship Lode Runner |

35 *Softkeys* | Hi-res Cribbage | Olympic Decathlon | Revisiting F-15 Strike Eagle | Masquerade | The Hobbit | *Readers' Softkeys* | Pooyan | The Perfect Score | Alice in Wonderland | The Money Manager | Good Thinking | Rescue Raiders | *Feature* | Putting a New F8 on Your Language Card | *Core* | Exploring ProDOS by installing a CPS Clock Driver |

34 *Softkeys* | Crisis Mountain | Terripin Logo | Apple Logo II | Fishies 1.0 | SpellWorks | Gumball | *Readers' Softkeys* | Rescue at Rigel | Crazy Mazey | Conan | Perry Mason: The Case of the Mandarin Murder | Koronis Rift | *Feature* | More ROM Running | *Core* | Infocom Revealed |

33 *Softkeys* | Word Juggler | Tink! Tonk! | Sundog v2.0 | G.I. Joe & Lucas Film's Eidolon | Summer Games II | Thief | Instant Pascal | World's Greatest Football Game | *Readers' Softkeys* | Graphic Adventure #1 | Sensible Grammar & Extended Bookends | Chipwits | Hardball | King's Quest II | The World's Greatest Baseball Game | *Feature* | How to be the Sound Master | *Core* | The Mapping of Ultima IV |

32 *Softkeys* | Revisiting Music Construction Set | Cubit | Baudville Software | Hartley Software | Bridge | Early Games for Young Children | Tawala's Last Redoubt | *Readers' Softkeys* | Print Shop Companion | Kracking Vol II | Moebius | Mouse Budget, Mouse Word & Mouse Desk | Adventure Construction Set | *Feature* | Using Data Disks With Microzines | *Core* | Super IOB v1.5 a Reprint |

31 *Softkeys* | Trivia Fever | The Original Boston Computer Diet | Lifesaver | Synergistic Software | Blazing Paddles | Zardax | *Readers' Softkeys* | Time Zone | Tycoon | Earthly Delights | Jingle Disk | Crystal Caverns | Karate Champ | *Feature* | A Little Help With The Bard's Tale | *Core* | Black Box | Unrestricted Ampersand |

30 *Softkeys* | Millionaire | SSI's RDOS | Fantavision | Spy vs. Spy | Dragonworld | *Readers' Softkeys* | King's Quest | Mastering the SAT | Easy as ABC | Space Shuttle | The Factory | Visidex 1.1E | Sherlock Holmes | The Bards Tale | *Feature* | Increasing Your Disk Capacity | *Core* | Ultimaker IV, an Ultima IV Character Editor |

29 *Softkeys* | Threshold | Checkers v2.1 | Microtype | Gen. & Organic Chemistry Series | Uptown Trivia | Murder by the Dozen | *Readers' Softkeys* | Windham's Classics | Batter Up | Evelyn Wood's Dynamic Reader | Jenny of the Prairie | Learn About Sounds in Reading | Winter Games | *Feature* | Customizing the Monitor by Adding 65C02 Disassembly | *Core* | The Animator |

28 *Softkeys* | Ultima IV | Robot Odyssey | Rendezvous | Word Attack & Classmate | Three from Mindscape | Alphabetic Keyboarding | Hacker | Disk Director | Lode Runner | MIDI/4 | *Readers' Softkeys* | Algebra Series | Time is Money | Pitstop II | Adventure to Atlantis | *Feature* | Capturing the Hidden Archon | *Core* | Fingerprint Plus: A Review | Beneath Beyond Castle Wolfenstein (part 2) |

27 *Softkeys* | Microzines 1-5 | Microzines 7-9 | Microzines (alternate method) | Phi Beta Filer | Sword of Kadash | *Readers' Softkeys* | Another Miner 2049er | Learning With Fuzzywomp | Bookends | Apple Logo II | Murder on the Zinderneuf | *Features* | Daleks: Exploring Artificial Intelligence | Making 32K or 16K Slave Disks | *Core* | The Games of 1985: part II |

26 *Softkeys* | Cannonball Blitz | Instant Recall | Gessler Spanish Software | More Stickybeats | *Readers' Softkeys* | Financial Cookbook | Super Zaxxon | Wizardry | Preschool Fun | Holy Grail | Inca | 128K Zaxxon | *Feature* | ProEdit | *Core* | Games of 1985 part I |

25 *Softkeys* | DB Master 4.2 | Business Writer | Barron's Computer SAT | Take 1 | Bank Street Speller | Where In The World Is Carmen Sandiego | Bank Street Writer 128K | Word Challenge | *Readers' Softkeys* | Spy's Demise | Mind Prober | BC's Quest For Tires | Early Games | Homeword Speller | *Feature* | Adding IF THEN ELSE To Applesoft | *Core* | DOS To ProDOS And Back |

24 *Softkeys* | Electronic Arts software | Grolier software | Xyphus | F-15 Strike Eagle | Injured Engine | *Readers' Softkeys* | Mr. Robot And His Robot Factory | Applecillin II | Alphabet Zoo | Fathoms 40 | Story Maker | Early Games Matchmaker | Robots Of Dawn | *Feature* | Essential Data Duplicator copy parms | *Core* | Direct Sector Access From DOS | ..

22 *Softkeys* | Miner 2049er | Lode Runner | A2-PBI Pinball | *Readers' Softkeys* | The Heist | Old Ironsides | Grandma's House | In Search of the Most Amazing Thing | Morloc's Tower | Marauder | Sargon III | *Features* | Customized Drive Speed Control | Super IOB version 1.5 | *Core* | The Macro System |

20 *Softkeys* | Sargon III | Wizardry: Proving Grounds of the Mad Overlord and Knight of Diamonds | *Reader' Softkeys* | The Report Card V1.1 | Kidwriter | *Feature* | Apple II Boot ROM Disassembly | *Core* | The Graphic Grabber v3.0 | Copy II+ 5.0: A Review | The Know-Drive: A Hardware Evaluation | An Improved BASIC/Binary Combo |

19 *Readers' Softkeys* | Rendezvous With Rama | Peachtree's Back To Basics Accounting System | HSD Statistics Series | Arithmetickle | Arithmekicks and Early Games for Children | *Features* | Double Your ROM Space | Towards a Better F8 ROM | The Nibbler: A Utility Program to Examine Raw Nibbles From Disk | *Core* | The Games of 1984: In Review-part II |

16 *Softkey* | Sensible Speller for ProDOS | Sideways | *Readers' Softkeys* | Rescue Raiders | Sheila Basic Building Blocks | Artsci Programs | Crossfire | *Feature* | Secret Weapon: RAMcard | *Core* | The Controller Writer | A Fix For The Beyond Castle Wolfenstein Softkey | The Lone Catalog Arranger Part I |

1 *Softkeys* | Data Reporter | Multiplan | Zork | *Features* | PARMS for Copy II Plus | No More Bugs | APT's for Choplifter & Cannonball Blitz | 'Copycard' Reviews | Replay | Crackshot | Snapshot | Wildcard |

CORE 3 **Games:**
Constructing Your Own Joystick | Compiling Games | *GAME REVIEWS:* Over 30 of the latest and best | Pick Of The Pack: All-time TOP 20 games | Destructive Forces | EAMON | Graphics Magician and GraFORTH | Dragon Dungeon |

CORE 2 **Utilities:**
Dynamic Menu | High Res: Scroll Demo | GOTO Label: Replace | Line Find | Quick Copy: Copy | ..

CORE 1 **Graphics:**
Memory Map | Text Graphics: Marquee | Boxes | Jagged Scroller | Low Res: Color Character Chart | High Res: Screen Cruncher | The UFO Factory | Color | Vector Graphics: Shimmering Shapes | A Shape Table Mini-Editor | Block Graphics: Arcade Quality Graphics for BASIC Programmers | Animation |

Hardcore Computing 3
HyperDOS Creator | Menu Hello | Zephyr Wars | Vector Graphics | Review of Bit Copiers | Boot Code Tracing | Softkey IOB | Interview with 'Mike' Markkula |

Looking for the Best Deal in Town?

How about ALL of our Super IOB controllers,
(through 1986) in ONE package!

This package contains:

- ▶ **TWO DISKS** (supplied in DOS 3.3). Each containing at least 60 Super IOB Controllers including the standard, swap, newswap and fast controllers. In addition, each disk has the C-saver program from COMPUTIST No. 13; version 1.5 of Super IOB; and a Menu Hello Program that lists the available controllers and, when you select one, automatically installs it in Super IOB and RUNs the resulting program.*
- ▶ A reprint of **Disk Inspection and the Use of Super IOB**, from COMPUTIST No. 17. This article explains how to write your own Super IOB controllers.
- ▶ **COMPUTIST No. 32**, which contains an extensive article detailing the hows and whys of Super IOB v1.5 and at least 5 articles using the new Super IOB program.
- Several of the controllers deprotect the software completely with no further steps. This means that some programs are only minutes away from deprotection (with virtually no typing).
- The issue of COMPUTIST in which each controller appeared is indicated in case further steps are required to deprotect a particular program.**

Disk 1

Volume 1 of the Super IOB collection covers all the controllers appearing in COMPUTIST No. 9 through No. 26. In addition, the newswap and fast controllers from COMPUTIST No. 32 are included. The following 60 controllers are on volume 1:

Advanced Blackjack, Alphabet Zoo, Arcade Machine, Archon II, Archon, Artsci Software, Bank Street Writer, Barrons SAT, Beyond Castle Wolfenstein, BSW //c Loader, Castle Wolfenstein, Computer Preparation: SAT, Dazzle Draw, DB Master 4 Plus, Death in the Carribean, Dino Eggs, DLM Software, Electronic Arts, F-15 Strike Eagle, Fast Controller, Fathoms 40, Financial Cookbook, Gessler Software, Grandma's House, The Heist, In Search of the Most Amazing Thing, Instant Recall, Kidwriter, Lions Share, Lode Runner, Mastertype, Match Maker, Miner 2049er, Minit Man, Mufplot, Newsroom, Newswap controller, Penguin Software, Print Shop Graphic Library, Print Shop, Rendezvous with Rama, Rockys' Boots, Sargon III, Sea Dragon, Shiela, Skyfox, Snooper Troops, Standard controller, Stoneware Software, Summer Games, Super Controller, Super Zaxxon, Swap Controller, TAC, Ultima III, Word Challenge, Xyphus, Zaxxon

Disk 2

Volume 2 of the Super IOB collection covers all the controllers appearing in COMPUTIST No. 27 through No. 38. The following 65 controllers are on volume 2:

Alice in Wonderland, Alphabetic Keyboarding, Alternate Reality, Autoduel, Checkers, Chipwits, Color Me, Conan.data, Conan.prog, CopyDOS, Crisis Mountain, Disk Director, Dragonworld, Early Games, Easy as ABC, F-15 Strike Eagle, Fantavision, Fast controller, Fishies, Flight Simulator, Halley Project, Hartley Software (a), Hartley Software (b), Jenny of the Prairie, Jingle Disk, Kidwriter, Kracking Vol II, Lode Runner, LOGO II (a), LOGO II (b), Masquerade, Mastering the SAT, Microtype: The Wonderful World of Paws, Microzines I, Microzines 2-5, Miner 2049er, Mist & View to a Kill, Murder on the Zinderneuf, Music Construction Set, Newswap controller, Olympic Decathlon, Other Side, Phi Beta Filer, Pitstop II, Print Shop Companion, RDOS, Robot War, Spy vs Spy, Standard controller, Sundog V2, Swap controller, Sword of Kadash, Synergistic Software, Tawala's last Redoubt, Terripin Logo, Threshold, Time is Money, Time Zone, Tink! Tonk!, Troll's Tale, Ultima IV, Wilderness, Word Attack & Classmate, World's Greatest Baseball, World's Greatest Football

To Order: Send \$9.95 for each disk or \$19.95 for a complete package. Most orders are shipped within 5 working days, however allow 4-6 weeks delivery for some orders. U.S. funds drawn on U.S. banks. Foreign orders (other than Canada or Mexico) add 20% shipping. Washington state residents add 7.8% sales tax. Mail orders to: Super IOB Collection PO Box 110846-T Tacoma, WA 98411

*Requires at least 64K of memory.

**Although some controllers will completely deprotect the program they were designed for, some will not and therefore require their corresponding issue of COMPUTIST to complete the deprotection procedure.