

Mountain Computer INCORPORATED

CPS MultiFunction Card
Reference Manual



CPS MultiFunction Card

Reference Manual

Manual Number 11-00214-06

Copyright 1982

Mountain[™] Computer Inc.
INCORPORATED

300 El Pueblo, Scotts Valley, CA 95066
TWX: 910 598-4504 14081438-6650

Table of Contents

Introduction

Chapter 1 Installation

1-1	Unpacking
1-1	Checking the Batteries
1-1	Preparing the Diskette
1-1	Plugging In
1-2	Phantom Slot Select
1-2	The 16 Pin Adapter (Apple II Installation)
1-3	The 16 Pin Adapter (Apple IIe Installation)
1-4	The 2 Pin Cable
1-5	The Card
1-6	The Last Step
1-6	Installation Summary

Chapter 2 CPS Card Peripheral Hookup Guide

2-1	Parallel Hookup Guide—CPS to Centronics 737 Printer
2-2	CPS Card Clock Setup
2-2	Serial Hookup Guide—CPS to 1640/1650 Diablo Printer
2-3	Parallel Hookup Guide—CPS to Epson MX80 & MX100 Printers
2-4	Serial Hookup Guide—CPS to Hazeltine 1500 Terminal
2-6	Parallel Hookup Guide—CPS to IDS 440 Printer
2-7	Serial Hookup Guide—CPS to IDS 440 Printer
2-8	Serial Hookup Guide—CPS to Cat & DC Hayes Modems
2-9	Serial Hookup Guide—CPS to TI 820 Printer
2-9	Parallel Hookup Guide—CPS to Anadex 8000 Printer
2-10	Serial Hookup Guide—CPS to 630 Diablo Printer
2-11	Serial Hookup Guide—CPS to C ITOH Printer
2-11	Multiple Device Hookup (Phantom Slots) CPS to Modem and Printer
2-13	Visidex Clock Patch

Chapter 3 The CPS Card Diskette

3-1	The Setup Program
3-1	Running the Program
3-1	Cataloging the Diskette
3-1	Loading a Setup File
3-2	Saving a Setup File
3-2	Setting the Device Parameters
3-2	Serial Input
3-2	Serial Output
3-3	Serial Control
3-3	Parallel Output

3-3	Setting Slot Assignments, or Phantom Slots
3-4	Phantom Slot Conflicts
3-4	Setting the Default Input Device
3-4	Setting the Default Output Device
3-5	Displaying or Printing the Parameters
3-5	Exiting the Program
3-5	Clock Programs
3-5	Setting the Time
3-6	Reading the Time
3-7	Program Examples
3-7	Date and Time
3-7	Clock and CPS Slot Finder
3-7	Time String
3-7	The Analog Clock II Program
3-7	The CPS Lister Program
3-8	Some Useful Subroutines
3-8	The CPS Slot Finder
3-8	The Setup File Loader

Chapter 4 Software Commands

4-1	Initialization
4-1	Command Sequences
4-2	In a BASIC Program
4-2	Initializing Both Input and Output
4-2	The Clock
4-3	The Serial Port
4-3	Parallel Port
4-3	Phantom Slots
4-3	Escape Codes
4-4	The Printing Environment
4-4	The High-Order Bit
4-4	Auto Line Feed After RETURN
4-4	Lower to Upper Case
4-4	Video Output On or Off
4-4	Ordinary or Special Display
4-5	Change Escape Code CTRL Character
4-5	Tabbing
4-5	Printing, Typing and the Video Display
4-6	Terminal Mode
4-6	Entering Terminal Mode
4-6	Editing in Terminal Mode
4-6	Terminal Mode Modifiers
4-6	Auto Line Feed
4-6	High-Order Bit
4-6	Convert Lower to Upper Case
4-7	Printing in Terminal Mode
4-7	Sending Commands Literally
4-8	Leaving Terminal Mode

Appendix A Using the CPS Card With Peripherals

A-1	Parity
A-1	Using a Modem
A-1	Half Duplex
A-1	Full Duplex
A-1	Carriers
A-2	Using a Serial Printer
A-2	Using a Parallel Printer
A-3	Serial Protocols (A Brief RS232 Tutorial)
A-3	Introduction
A-3	Handshaking
A-3	RC Signal Pair
A-3	ST Signal Pair
A-3	Data Carrier Detected
A-4	Parallel Data Bus Tutorial
A-4	The Strobe Line
A-5	ACKNOWLEDGE/BUSY Line
A-5	Parallel Data Lines

Appendix B Advanced Programmer's Information

B-1	General Organization
B-2	Serial Handshaking Protocol
B-2	Other Information
B-2	Using the CPS Card From The Monitor
B-2	Using the Card From Machine Language Programs
B-3	The Phantom Slot Feature
B-4	CPS Hardware Location Summary
B-4	Hardware Location Summary Organization
B-9	CPS I/O Cables

Appendix C Troubleshooting

C-1	Error Messages
-----	----------------

Appendix D Quick Reference Sheet

Introduction

Congratulations on your purchase of Mountain Computer's CPS MultiFunction card! This card is actually three cards in one: a bi-directional serial interface, a parallel output interface, and a real-time clock/calendar.

The CPS Card provides an interface between the Apple II* Computer and peripheral support equipment. Any BASIC or Machine Language software for the Apple II*, including VisiCalc** and software written for the Mountain Computer Clock Card, will work with the CPS card.

The CPS Card has some exceptional built-in features.

- All three CPS Card devices can be used from one peripheral card.
- The CPS Card has its own battery-backed memory in which configuration information for individual devices is stored.
- CPS Card peripherals can use "phantom" slots in the Apple II, independent of the slot in which the CPS Card is plugged. This feature allows compatibility with existing slot dependent software without inconvenient "card swapping."
- With the CPS Card serial interface you have access to a special Terminal Mode which lets the Apple accept and send information without processing it.
- The CPS Card doesn't use the C800 space so there is no C800 conflict.

Some useful programs are included with the CPS Card. The most important of these is the Setup program. This program lets you change the configuration information stored on the CPS Card. You can use one of the ready-made "Setup" files we supply, or tailor the configuration information to your specific application.

Also included with the CPS Card are two demonstration programs that use some of the Card's special abilities. One of these programs demonstrates the clock/calendar working in conjunction with a printer to list formatted Applesoft BASIC programs with a "time stamp" at the top of each page. The other demonstration program displays the correct time with a picture of a clock, complete with moving hands, on the Apple high-resolution graphics screen.

In addition, two subroutines you may wish to incorporate in your BASIC programs are included on the diskette. These subroutines can be "EXECed" into Integer or Applesoft BASIC programs.

The CPS Card is supplied without I/O cables. Refer to the MCI Product Catalog for a list of peripheral I/O cables and prices.

* Apple II is a trademark of Apple Computer Inc.

**VisiCalc is a trademark of Personal Software Inc.

Chapter 1 Installation

To use the CPS MultiFunction Card you need an Apple II or II Plus with at least 32K memory and a disk drive. The CPS Card works with the Apple Language Systems running BASIC. Routines are available, on diskette, that allow Apple Pascal* (MCI PN **12-00417**) and Z-80 SoftCard*** (**two sided disk**) to be used with the MCI CPS MultiFunction Card.

Installing the CPS Card is easy, but it must be done carefully. To avoid damaging your card, read this chapter thoroughly.

Unpacking

Carefully unpack your CPS MultiFunction Card. Handle the card gently, holding it by the edges. Take note of the way in which it was packed and save all packing materials in case you need to repack it for shipping at a later date.

You should find the following items in the CPS Card Box:

- This manual
- A CPS Card with two AA batteries installed
- A 12 inch cable with a two pin connector on each end
- An empty IC socket
- A CPS Card diskette
- A Warranty Registration Card

If any of these items are missing from your package, contact your dealer immediately.

Before doing anything else, fill out and mail the Warranty Registration Card. Mailing in this card helps to protect your investment by letting us know where to send updates and improvements that may be developed for the CPS Card.

If you have installed a CPS Card before, you may want to skip to the section called "Installation Summary" near the end of this chapter. That section gives brief installation instructions for those who are familiar with installing the CPS Card.

Checking the Batteries

Two regular AA alkaline batteries are installed on the back (the side without components) of the CPS Card. Verify that the batteries are firmly seated in the battery housing (refer to Figure 1-1).

CAUTION: The batteries must be installed as shown (the inside of the battery housing also indicates the proper battery positioning) otherwise the CPS Card will not operate.

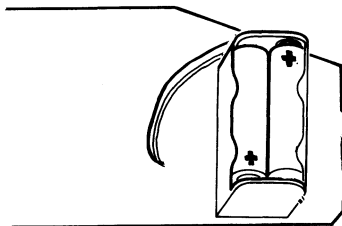

Figure 1-1 Battery Installation

Preparing the Diskette

The CPS Card diskette has a 16 sector format. If your disk drives are set up for 13 sector contact your dealer or Mountain Computer Customer Service for 13 sector diskette availability.

Before you install the CPS Card, use the DOS Copy program to make a copy of the CPS Card diskette. Use the copy as your "working" diskette, and store the master in a safe place. Never use the master copy for anything except making copies.

Plugging In

The following section describes System modification and CPS Card installation.

CAUTION: Turn the Apple power switch to OFF before installing or removing cards or devices in the Apple II chassis. Failure to follow this procedure may damage the Apple and/or the CPS Card.

*Apple Pascal is a trademark of Apple Computer Inc.
**Z-80 SoftCard is a trademark of Microsoft Consumer Products.

Phantom Slot Select

The current CPS Multifunction cards (Revision G and above) have a phantom slot enable/disable jumper at the bottom of the card as shown in Figure A. The new board also has the two-pin cable connectors (Figure 1-5 in the manual) repositioned vertically as shown.

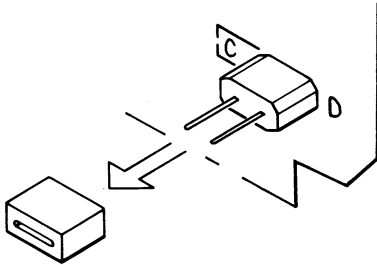

Figure 1- Phantom Slot Jumper Location 707811

When a jumper is placed between pins C and D, the phantom slot feature is enabled (available for use). The phantom slot feature allows you to place your CPS card in one Apple I/O slot and select another slot (phantom slot since the CPS card is not located there) and connect it to a peripheral device.

For example, you wish to connect a serial modem and a parallel printer to the CPS card at the same time. You could physically locate the CPS card in Apple I/O slot 1 and set the CPS card parameters to serial I/O for slot 1. Then connect the modem interface cable to the CPS card serial connector. Finally, you would phantom select Apple slot 2, set the CPS parallel parameters for slot 2 and connect your parallel printer cable to the parallel connector on the CPS card. Now you have two devices connected to the Apple from physical slot 1, but the Apple thinks slot 1 is a serial device and slot 2 is a parallel device.

If you do not wish to use the phantom slot feature, remove the jumper from pins C and D and ignore the Apple modification steps that follow.

The 16 Pin Adapter (Apple II Installation)

Modify the Apple II Main Circuit Card at card device location H12 by performing the following steps (refer to step 1e for Apple 2e Installation):

1. Remove 74LS138 integrated circuit (IC) at location H12 (refer to Figure 1-2) by gently working it free from its socket. We recommend that you use an IC puller (available from your dealer). Do not bend the IC leads as it will be difficult to re-install.

NOTE: The IC's on the Apple's main board are located by a column/row matrix (similar to a map street locator). Each row is

labeled with a letter from A through K (left side of the card). H12 is the third device position from the right in row H.

2. Insert the PWA Adapter cable connector (MCI02-00211) that came with the CPS Card into the socket at location H12. Insure that connector pin 1 is oriented as shown in Figure 1-3.
3. Fasten the CPS Mini Card to the inside of the Apple Case (right side of the mother board.)

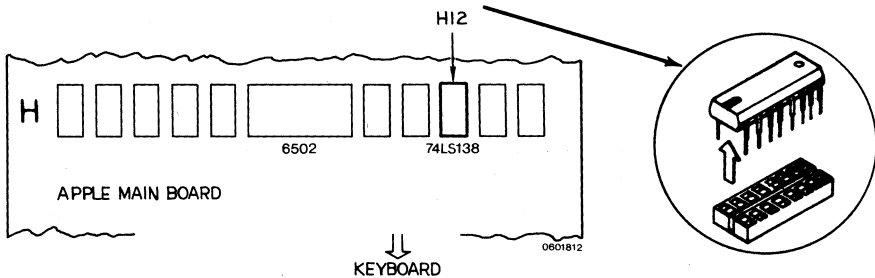

Figure 1-2 IC H12 Location
(Apple Main Board)

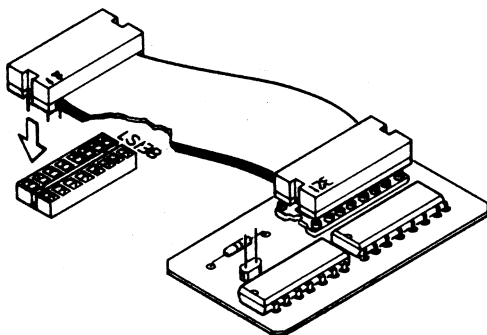

Figure 1-3 New Socket Orientation
(Location H12)

The 16 Pin Adapter (Apple IIe Installation)

Modify the Apple IIe Main Circuit Card at card device location B5 by performing the following steps:

- 1e. Remove 74LS138 integrated circuit (IC) at location B5 (refer to Figure 1-4) by gently working it free from its socket. We recommend that you use an IC puller (available from your dealer). Do not bend the IC leads as it will be difficult to re-install.

NOTE: The IC's on the Apple's main board are located by a column/row matrix (similar to a map street locator). Each row is

labeled with a letter from A through F (left side of the card). B5 is the fifth device position from the left in row B.

- 2e. Insert the PWA Adapter cable connector (MCI02-00211) that came with the CPS Card into the socket at location B5. Insure that connector pin 1 is oriented as shown in Figure 1-3.
- 3e. Fasten the CPS Mini Card to the inside of the Apple Case (right side of the mother board).

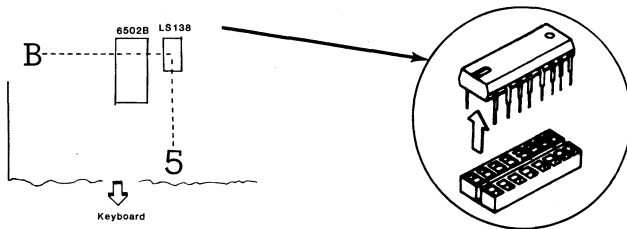

Figure 1-4 IC B5 Location
(Apple IIe Main Board)

The 2 Pin Cable

The 2 pin cable will connect the CPS Card to the 16 pin socket you plugged into the Apple main board.

Plug either end of the cable into the CPS Adapter socket so that the black wire is

toward the keyboard. Make sure it is seated firmly. Then plug the opposite end of the cable into dual plug J6 (either one) on the CPS Card, with the red wire on top as shown in Figure 1-5.

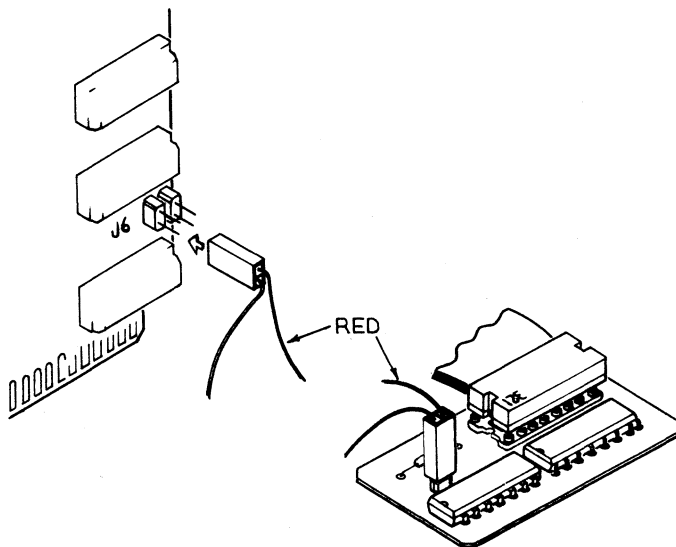

Figure 1-5 CPS Card 2-Pin Cable Installation

The Card

The eight peripheral slots in the Apple are numbered from 0 to 7. The CPS Card can be plugged into any of these except slot #0, which is reserved for special cards, such as the Language System or a ROM card.

Plug the CPS Card into any slot numbered from 1 to 7. The gold plated connectors on one

edge of the card should go into the slot with just a little resistance and then settle firmly in the slot. Figure 1-6 shows a CPS Card that is plugged in correctly.

CAUTION: To avoid damaging the Apple and the CPS Card, make sure the CPS Card is firmly seated in the slot before you turn on the power.



Figure 1-6 CPS Card Installation

After the card has been installed, turn on the Apple's power, and boot the CPS Card diskette. If you are able to boot the diskette, everything is installed correctly and you may skip to the next section, called "The Last Step."

If your disk drive will not boot, one of three things is probably wrong:

- the 2 pin cable is plugged in backwards
- the CPS Card is trying to use your disk slot as a phantom slot.
- a dead battery or invalid RAM I/O select parameters are disabling all (or some) Apple peripheral slots.

First make sure the 2 pin cable is oriented properly. If you are sure it is plugged in the right way, but your disk drive still doesn't boot, the CPS Card is probably trying to use the slot in which your disk drive is plugged for a "phantom slot". Phantom slots will be discussed in detail later .

If this has happened, you must give a simple Monitor instruction to the Card. First enter the Monitor. You'll know you are in the Monitor when you see an asterisk (*) prompt on the left edge of the screen.

If you don't have an Auto Start ROM, simply press RESET to enter the monitor. If you do have an Auto Start ROM, type

CALL -151

exactly as shown, and press the RETURN key. When you are in the monitor, type

CnF7:0

where n is the CPS Card slot number, press RETURN, and then press the RESET key. For example, if your CPS Card is plugged into slot #3, type

C3F7:0

and then press RETURN and RESET.

The Last Step

This step prepares the CPS Card for action by loading a set of system default parameters. Boot the CPS Card diskette (if you haven't already). You'll know the diskette has been successfully booted when the title screen appears.

Type

RUN SETUP

and press RETURN to run the program. A list of options, called the Primary Setup Menu, will appear on the screen (refer to Figure 1-8). Each of these options will be discussed in detail in Chapter 2, The CPS Card Diskette. For now, choose option 9, EXIT. When the cursor appears in the top left corner of the screen, the last installation step has been completed. Refer to Chapter 2 for connection to a specific device.

Installation Summary

If you are familiar with installing peripherals in the Apple II, or if you have installed a CPS MultiFunction Card before, you may want to read this brief summary instead of the entire chapter. However, if you are not experienced with installing Apple peripherals do not attempt to skip the earlier sections.

1. Check that the two batteries in the CPS card are secure.
2. Turn the power OFF!
3. Remove the IC from location H12 on the Apple mother board.
4. Plug the 16 pin socket that came with the CPS card into the 16 pin socket at location H12 on the Apple mother board, and then plug the IC into the 16 pin socket. Make sure the beveled corner on the 16 pin socket and the notch or dot on the IC are toward the keyboard.
5. Turn on the Apple and boot the disk to check that the socket is correctly installed.
6. Turn off the Apple and attach one end of the two pin cable to the connector located on the 16 pin IC socket and the other end to the J6 connector on the CPS card. In both cases make sure the red cable is toward the Apple keyboard when the card is installed.
7. Plug the CPS card into a peripheral slot in the Apple (any slot from 1 to 7).
8. Turn the Apple on and run the Setup program (Figure 1-8), and choose option 9, EXIT, from the menu.
9. Refer to Chapter 2 to connect the CPS Card to a specific device.

**** PRIMARY MENU ****

OPTION

0 - CATALOG

1 - LOAD SETUP FILE

2 - SAVE SETUP FILE

3 - SET DEVICE PARAMETERS

4 - SET SLOT ASSIGNMENTS

5 - SET THE TIME

6 - SET DEFAULT INPUT DEVICE

7 - SET THE DEFAULT OUTPUT DEVICE

8 - DISPLAY OR PRINT PARAMETERS

9 - EXIT

SELECT OPTION # --

Figure 1-8 CPS Setup Primary Menu

Chapter 2 CPS Card to Peripheral Device — Hookup Guide

This Chapter contains information on how to initialize the CPS Card with various peripheral devices (printers, modems, and terminals). **The CPS MultiFunction Card must be installed in an Apple peripheral slot (Chapter 1 of this manual) before attempting to connect the card to one of the devices listed in this chapter.**

Peripheral device models and/or manufacturers not listed in this Chapter can be easily interfaced to the CPS Card. Use a device hookup listed in this Chapter that is similar to your device and:

- Compare the I/O cable signal requirements with the devices listed in this Chapter. The peripheral device maintenance and/or operating manual should contain I/O pin-out information.
- Fabricate or buy a cable* that routes the I/O signals to the correct connector pins of the CPS Card (J4 or J5) and the peripheral device (the MCI Matrix Switch PN 01-00243-01 may simplify this task for serial RS232 applications). Appendix B contains pin-out information for the CPS Card. If the pin-out information (including the DB-25 connector) for your device is identical to one of the devices listed in Appendix A, then buy the appropriate MCI cable.
- Determine the device parameter requirements (baud rate, auto line feed ON/OFF, stop bits, parity, etc.) for your peripheral. The device maintenance and/or operating manual should contain this information.
- Set the device parameters via software (refer to the device parameter menus in the Setup program) and/or peripheral device hardware (switches, jumpers, etc.) to establish a working interface.
- Appendix B of this Manual contains additional I/O interface information.

Parallel Hookup Guide— CPS Card to Centronics 737 Printer

To hookup the printer to the CPS Card, perform the following:

1. Connect the MCI 01-00264-01 cable between the CPS Card J5 connector and Centronics™ printer as shown in Figure 2-1.

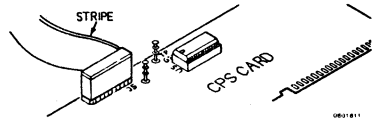

Figure 2-1 Parallel Cable Hookup

2. a. Verify that the CPS Card jumpers are set as shown in Figure 2-2.

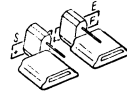

Figure 2-2 CPS+S and EF Jumper positioning

- b. Set the printer Auto Linefeed switch to OFF (all other switches for normal operation). Refer to the printer operation manual for additional information.
3. Turn the Apple POWER switch ON and boot the CPS MULTIFUNCTION BASIC diskette (MCI PN 12-00215-XX).
4. Type **RUN SETUP** and press the RETURN key. This will display the Setup File Primary Menu (Figure 2-3).

** PRIMARY MENU **

OPTION

- 0 - CATALOG
- 1 - LOAD SETUP FILE
- 2 - SAVE SETUP FILE
- 3 - SET DEVICE PARAMETERS
- 4 - SET SLOT ASSIGNMENTS
- 5 - SET THE TIME
- 6 - SET DEFAULT INPUT DEVICE
- 7 - SET DEFAULT OUTPUT DEVICE
- 8 - DISPLAY OR PRINT PARAMETERS
- 9 - EXIT

SELECT OPTION # --

Figure 2-3 Setup File Primary Menu

*The CPS Card is supplied without I/O cables. Refer to the MCI Product Catalog for a list of peripheral I/O cables and prices.

NOTE: If your diskette will not boot, refer to Chapter 1 of this manual.

5. Type **1** and the Load Setup File frame (Figure 2-4) will be displayed.

**** LOAD SETUP FILE ****

ENTER THE SETUP FILE NAME AND PRESS RETURN. (RETURN ONLY TO EXIT)

-- **SETUP.**

Figure 2-4 Load Setup File

6. Type **PARALLEL** and press the RETURN key. A LOAD IN PROGRESS prompt will be displayed and the program will return to the Primary Menu (Figure 2-3).

NOTE: To start over, at any point during the hookup procedure (made a mistake, lost, etc.), press the RESET key. If the Applesoft prompt appears, perform step 4. If an asterisk (*) appears, type **3DOG** and press the RETURN key, then perform step 4.

7. Quit the Setup Program Primary Menu by typing **9**.
8. The monitor screen will clear and the BASIC program prompt will appear, type **PR#n** (n = the Apple peripheral slot that contains the CPS Card) and press the RETURN key.

The printer is now on line and the print head should return to the left margin.

9. Type **EUREKA** and verify the printer "has found it" (EUREKA will be printed by the Centronics Printer).

This completes the printer hookup procedure. For additional hookup information (phantom slots, etc.) refer to Chapter 3 of this manual and the Multiple Device Hookup Section in this Chapter.

CPS Card Clock Setup

To setup the CPS Card Clock, perform the following:

1. Turn the Apple POWER switch ON and boot the CPS MULTIFUNCTION BASIC diskette (MCI PN 12-00215-01).
2. Type **RUN SETUP** and press the RETURN key. This will display the Setup File Primary Menu (Figure 2-3).

NOTE: To start over, at any point during the hookup procedure (made a mistake, lost, etc.), press the RESET key. If the Applesoft prompt (bracket) appears on the monitor, perform step 2. If an asterisk appears, type **3DOG**, press the RETURN key, and perform step 2.

3. Type **5**, this will display the Set the Time frame (Figure 2-5).

**** SET THE TIME ****

ENTER THE DATE AND TIME IN THE FORM SHOWN BELOW. THEN PRESS RETURN TO VERIFY YOUR ENTRY.

ENTER DATE & TIME— _____,
19____:_____M

EXAMPLE: OCT 3, 1984 12:30 PM
(PRESS RETURN FOR VERIFICATION)

Figure 2-5 Set the Time

4. Enter the date and time plus one additional minute and press the RETURN key. This will display a Start the Clock prompt. When the time is equal to the time entered, press the RETURN key. This will return the program to the Primary Menu (Figure 2-3).
5. Type **9** to exit the Primary Menu.
6. The monitor screen will clear and the BASIC program prompt will appear, type **RUN ANALOG CLOCK II** and press the RETURN key.

The correct time should be displayed (via the clock face) on the monitor.

This completes the clock setup procedure. For additional hookup information (phantom slots, etc.) refer to Chapter 3 of this manual and the Multiple Device Hookup Section in this Chapter.

Serial Hookup Guide — CPS Card to 1640/1650 Diablo Printer

To hookup the printer to the CPS Card, perform the following:

1. a. Connect the MCI 01-00299-XX cable between the CPS Card J4 connector and the Diablo™ printer as shown in Figure 2-6.

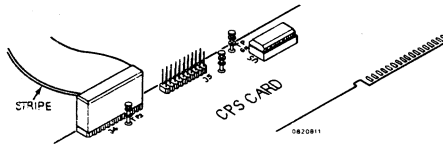

Figure 2-6 Serial Cable Hookup

- b. Position the Diablo switches to conform to the following I/O requirements (refer to the Diablo Maintenance manual).

Baud Rate: 1200 Parity: Off
 Auto Line Feed: Off Mode: Remote

6. Type **9** to exit the program.
7. The Apple monitor screen will clear and the BASIC prompt will appear, type **PR#n** (n = the Apple peripheral slot that contains the CPS Card) and press the RETURN key.
8. Type **EUREKA** and verify that the printer "has found it" (EUREKA will be printed by the Diablo printer).

This completes the printer hookup procedure. For additional hookup information (phantom slots, etc.) refer to Chapter 3 of this manual and the Multiple Device Hookup Section in this Chapter.

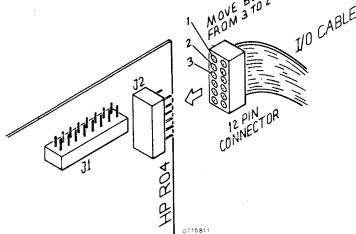

Figure 2-7 Diablo DTR Modification

2. Turn the Apple POWER switch ON and boot the CPS MULTIFUNCTION BASIC diskette (MCI PN 12-00215-XX).
3. Type **RUN SETUP** and press the RETURN key. This will display the Primary Menu (figure 2-3).
4. Enter **1** and the Load Setup File frame (Figure 2-4) will be displayed.

NOTE: To start over, at any point during the hookup procedure (made a mistake, lost, etc.) press the RESET key. If the Applesoft prompt (bracket) appears on the monitor, perform step 3. If an asterisk appears, type **3DOG**, press the RETURN key and perform step 3.

5. Type **SERIAL** and press the RETURN key. This will load the serial (Diablo) device parameters resident on the CPS Card diskette and return to the Primary Menu (Figure 2-3).

Parallel Hookup Guide— CPS Card to Epson MX80 & MX100 Printers

To hookup the Epson™ Printer for parallel I/O operation, perform the following:

1. Connect the MCI 01-00264-01 cable between the CPS Card J5 connector and the printer as shown in Figure 2-1.
2. a. Verify the CPS Card jumpers are set as shown in Figure 2-2.
 b. Verify that the Epson internal switches are set as follows:

DIP Switch 1

- Section 1 - ON (No connection)
- ⌞ 2 - ON (Auto CR)
 - ⌞ 3 - ON (Auto LF)
 - ⌞ 4 - OFF (Cancel Code)
 - ⌞ 5 - ON (Delete Code)
 - ⌞ 6 - ON (Buzzer On)
 - ⌞ 7 - OFF (Graphics Char.)
 - ⌞ 8 - ON (Remote Control Off)

DIP Switch 2

- Section 1 - ON (U.S.A.)
2 - ON (char. set)
3 - OFF (Auto LF Off)
4 - OFF (all codes)
- Turn the Apple POWER switch ON and boot the CPS MULTIFUNCTION BASIC diskette (MCI PN 12-00215-XX).
 - Type **RUN SETUP** and press the RETURN key. This will display the Setup File Primary Menu (Figure 2-3).
 - Type **1** and the Load Setup File frame (Figure 2-4) will be displayed.
 - Type **PARALLEL** and press the RETURN key. A LOAD IN PROGRESS prompt will be displayed and the program will return to the Primary Menu (Figure 2-3).
 - Quit the Setup Program Primary Menu by typing **9**.
 - The monitor screen will clear and the BASIC program prompt will appear, type **PR#n** (n = the Apple peripheral slot that contains the CPS Card) and press the RETURN key.

The printer is now on line and the print head should return to the left margin.

- Type **EUREKA** and verify the printer "has found it" (EUREKA will be printed by the Epson).

This completes the printer hookup procedure. For additional hookup information (phantom slots, etc.) refer to Chapter 3 of this Manual and the Multiple Device Hookup Section in this Chapter.

Serial Hookup Guide— CPS Card to Hazeltine 1500 Terminal

To hookup the terminal to the CPS Card perform the following:

- a. Connect the MCI01-00266-01 cable between the CPS Card J4 connector and the Hazeltine™ terminal as shown in Figure 2-6.
- b. Place the Hazeltine front panel switches (under the cover) in the following positions:

BAUD RATE 110 thru 9600: OFF
PARITY EVEN, ODD, 1 & 0: OFF
AUTO LF: OFF
STD VIDEO: ON
BAUD RATE 19.2K: ON
HALF DUPLEX: OFF (FULL)
U/L CASE: ON
CUR LOOP 1 and 2: OFF (EIA ON)

- Turn the Apple POWER switch ON and boot the CPS MULTIFUNCTION BASIC diskette (MCI PN 12-00215-XX).
- Type **RUN SETUP** and press the RETURN key. This will display the Primary Menu (Figure 2-3).
- Enter **6** and the Set Default Input Device frame (Figure 2-8) will be displayed.

NOTE: To start over, at any point during the hookup procedure (made a mistake, lost, etc.), press the RESET key. If the Applesoft prompt appears, perform step 3. If an asterisk (*) appears, type **3DOG** and press the RETURN key, then perform step 3.

```
** SET DEFAULT INPUT DEVICE **  
ID  DEVICE  
C - CLOCK  
S - SERIAL PORT  
(THE CURRENT CHOICE IS _____)  
SELECT DEVICE ID -- ____  
(RETURN TO EXIT)
```

Figure 2-8 Set Default Input Device

- Type **S** and press the RETURN key. This will select the serial port as the default input device. The program will return to the Primary Menu (Figure 2-3).
- a. Enter **7** and the Set Default Output Device frame (Figure 2-9) will appear.

```
** SET DEFAULT OUTPUT DEVICE **  
ID  DEVICE  
C - CLOCK  
P - PARALLEL PORT  
(THE CURRENT CHOICE IS _____)  
SELECT DEVICE ID -- ____  
(RETURN TO EXIT)
```

Figure 2-9 Set Default Output Device

- b. Type **S** and press the RETURN key. This will set the default output to the serial port and the program will return to the Primary Menu (Figure 2-3).
7. a. Select option 3, Set Device Parameters, from the Primary Menu (type 3). This will display the Set Device Parameters Menu 1 frame (Figure 2-10).

**** SET DEVICE PARAMETERS ****
**** GROUP SELECTION ****

```
# GROUP
1 - CLOCK INPUT
2 - SERIAL INPUT
3 - SERIAL OUTPUT
4 - SERIAL OUTPUT
5 - PARALLEL OUTPUT

SELECT GROUP 3 -- _____
(RETURN TO EXIT)
```

Figure 2-10 Set Device Parameters Menu 1

- b. Type **3** this will display the Set Device Parameters Menu 2 (Figure 2-11).

**** SET DEVICE PARAMETERS ****
**** SERIAL OUTPUT ****

```
# PARAMETER          CURRENT
1 - ESCAPE CODE      CTRL-I
2 - HIGH-ORDER BIT   CLEAR
3 - AUTO LINE FEED   YES
4 - LINE LENGTH      80
5 - PAGING           NO
   PAPER SIZE        0
   STEP OVER         0
6 - CONVERT LOWER -  NO
   UPPER
7 - CR DELAY AMOUNT  0

SELECT PARAMETER 3 -- _____
(RETURN TO EXIT)
```

Figure 2-11 Set Device Parameters Menu 2

- c. Type **5**. This will display the Set Device Parameters Menu 3 frame (Figure 2-12).

**** SET DEVICE PARAMETERS ****
**** SERIAL OUTPUT ****
**** PAGING ****

AUTOMATIC PAGING CAN BE ENABLED (YES) OR DISABLED (NO). IF YES IS CHOSEN, THEN THE PAPER SIZE (IN LINES) AND THE NUMBER OF LINES TO STEP OVER THE PERFORATION MUST BE SPECIFIED.

THE CURRENT CHOICE IS ----)
(PAPER SIZE = -- STEP OVER = _____)
ENABLE PAGING ? (Y OR N) -- _____
(RETURN TO EXIT)

Figure 2-12 Set Device Parameters Menu 3

- d. Type **N**. This will return the program to the Set Device Parameters Menu 2 (Figure 2-11). The CPS paging parameters are now disabled. Verify that the parameters displayed on the monitor are identical to those shown in Figure 2-11. Another parameter can be selected for modification or press the RETURN key to return to the Set Device Parameters Menu 1 frame (Figure 2-10).
- e. Type **4**. This will display the Set Device Parameter Menu 4 (Figure 2-13).

**** SET DEVICE PARAMETERS ****
**** SERIAL CONTROL ****

```
# PARAMETER          CURRENT
1 - BAUD RATE        19200
2 - PARITY            NO PARITY
3 - CHARACTER LENGTH 8
4 - NUMBER OF STOP   1
   BITS

SELECT PARAMETER 3 -- _____
(RETURN TO EXIT)
```

Figure 2-13 Set Device Parameters Menu 4

- f. Type **1**. This will display the Set Device Parameters Menu 5 (Figure 2-14).

**** SET DEVICE PARAMETERS ****

**** SERIAL BAUD RATE ****

**THE FOLLOWING BAUD RATES
ARE AVAILABLE:**

ID	BAUD	ID	BAUD
A	- 50	I	- 1800
B	- 75	J	- 2000
C	- 110	K	- 2400
D	- 134.5	L	- 3600
E	- 150	M	- 4800
F	- 300	N	- 7200
G	- 600	O	- 9600
H	- 1200	P	- 19200

(THE CURRENT CHOICE IS _____)

**SELECT BAUD RATE ID -- _____
(RETURN TO EXIT)**

Figure 2-14 Set Device Parameters Menu 5

- g. Type **P** and press the RETURN key. This will set the baud rate at 19200 and the program will return to the Set Device Parameters Menu 4 (Figure 2-13). Verify that the parameters displayed on the Apple monitor are identical to those shown in Figure 2-13. Another parameter can be selected for modification or press the RETURN key to return to the Set Device Parameters Menu 1 frame (Figure 2-10).
- h. Select option 2, Serial Input, from the Set Device Parameters (type 2) Menu 1. This will display the Set Device Parameters Menu 6 frame (Figure 2-15).

**** SET DEVICE PARAMETERS ****

**** SERIAL INPUT ****

#	PARAMETER	CURRENT
1	- CONVERT LOWER = UPPER	NO
2	- ECHO CHARACTER	NO

**SELECT PARAMETER # -- _____
(RETURN TO EXIT)**

Figure 2-15 Set Device Parameters Menu 6

- i. Verify that the serial input parameters are set as shown in Figure 2-15 (if not modify the parameter) and press the RETURN key to display the Set Device Parameters Menu 1 Frame (Figure 2-10).
8. Quit the Set Device Parameters Menu by pressing the RETURN key.
9. Quit the Setup Program Primary Menu by typing **9**.
10. a. The Apple monitor screen will clear and the BASIC prompt will appear, type **PR#n** (n = the Apple peripheral slot that contains the CPS Card).
Apple output will now be routed to the Hazeltine terminal and the BASIC program prompt will appear on the Hazeltine terminal CRT.
- b. Type **IN#n** (n = the Apple peripheral slot that contains the CPS Card).
Hazeltine keyboard input will now be routed to the Apple.

11. Type **CATALOG** and press the Hazeltine RETURN key. This will display a directory of the files resident on the CPS Multi-Function Basic diskette.

This completes the terminal hookup procedure. For additional hookup information (phantom slots, etc.) refer to Chapter 3 and the Multiple Device Hookup Section in this Chapter.

Parallel Hookup Guide— CPS Card to IDS 440 Printer

For a parallel hookup of the IDS™ Printer to the CPS Card, perform the following.

1. a. Connect the MCI 01-00263-01 cable between the CPS Card J5 connector and the printer as shown in Figure 2-1.
- b. If your CPS Card has an IDS jumper, connect the jumper as shown in Figure 2-16.

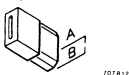

Figure 2-16 IDS Jumper

If your CPS Card does not have an IDS jumper, then remove the 74LS136 IC at location U3 on the CPS Card.

Install the 74LS86 IC, included with the cable assembly, in the socket at location U3. The IC has a notch (or slot) that indicates the side of the IC that faces U2. Refer to Figure 2-17 for proper IC orientation.

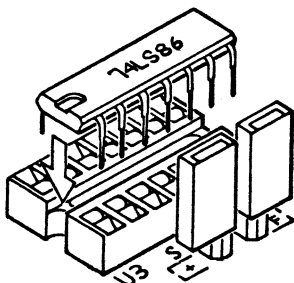

Figure 2-17 74LS86 IC Installation

- c. Verify that the CPS Card jumpers are set as shown in Figure 2-2.
- d. Set the printer switches to the following positions:
 - DIP Switch 4 Section 4 OFF (no auto line feed)*
 - Section 5 OFF (no auto paging)
2. Turn the Apple POWER switch ON and boot the CPS MULTIFUNCTION BASIC diskette (MC PN 12-00215-XX).
3. Type **RUN SETUP** and press the RETURN key. This will display the Setup File Primary Menu (Figure 2-3).
4. Type **1** and the Load Setup File frame (Figure 2-4) will be displayed.

NOTE: To start over, at any point during the hookup procedure (made a mistake, lost, etc.), press the RESET key. If the Applesoft prompt appears perform step 3. If an Asterisk (*) appears, type **3D0G** and press the RETURN key, then perform step 3.

5. Type **PARALLEL** and press the RETURN key. A LOAD IN PROGRESS prompt will be displayed and the program will return to the Primary Menu (Figure 2-3).
6. Quit the Setup Program Primary Menu by typing **9**.
7. The monitor screen will clear and the BASIC program prompt will appear. Type **PR#n** (n = the Apple peripheral slot that contains the CPS Card) and press the RETURN key.

The printer is now on line and the print head should return to the left margin.

8. Type **EUREKA** and verify the printer "has found it" (EUREKA will be printed by the IDS Printer).

This completes the printer hookup procedure. For additional hookup information (phantom slots, etc.) refer to Chapter 3 of this manual and the Multiple Device Hookup Section in this Chapter.

Serial Hookup Guide— CPS Card to IDS 440 Printer

For a serial hookup of the IDS™ Printer to the CPS Card perform the following:

1. a. Connect the MC 01-00265-01 cable between the CPS Card J4 connector and the printer as shown in Figure 2-6.
- b. Set the printer switches to the following positions:
 - DIP Switch 3 Section 7 ON (Serial Interface)
 - Section 4 ON (1200 Baud)
 - Section 5 ON (1200 Baud)
 - DIP Switch 4 Section 5 OFF (Auto Line Feed Off)
 - Section 4 OFF (Auto Paging Off)
2. Turn the Apple POWER switch ON and boot the CPS MULTIFUNCTION BASIC diskette (MCI PN 12-00215-XX).

*Set ON for dual mode and set OFF in Device Parameters menu (refer to CPS Multifunction Reference manual for additional information.)

3. Type **RUN SETUP** and press the RETURN key. This will display the Setup File Primary Menu (Figure 2-3).
4. Type **1** and the Load Setup File frame (Figure 2-4) will be displayed.

NOTE: To start over, at any point during the hookup procedure (made a mistake, lost, etc.), press the RESET key. If the Applesoft prompt appears perform step 3. If an asterisk (*) appears, type **3DOG** and press the RETURN key, then perform step 3.

5. Type **SERIAL** and press the RETURN key. A LOAD IN PROGRESS prompt will be displayed and the program will return to the Primary Menu (Figure 2-3).
6. Quit the Setup Program Primary Menu by typing **9**.
7. The monitor screen will clear and the BASIC program prompt will appear, type **PR#n** (n = the Apple peripheral slot that contains the CPS Card) and press the RETURN key.

The printer is now on line and the print head should return to the left margin.

8. Type **EUREKA** and verify the printer "has found it" (EUREKA will be printed by the IDS PRINTER).

This completes the printer hookup procedure. For additional hookup information (phantom slots, etc.), refer to Chapter 3 of this manual and the Multiple Device Hookup Section in this Chapter.

Serial Hookup Guide— CPS Card to CAT™ and HAYES™ Modems

This procedure describes how to connect the CPS card to a modem. The Apple™ can then be used to communicate with data base services (the Source™, etc.) over standard phone lines.

To hookup the modem to the CPS Card, perform the following:

1. Turn the Apple rear panel POWER switch to the OFF position.

2. Connect the MCI 01-00156-01 cable between the CPS Card J4 connector and the modem as shown in Figure 2-6.
3. Turn the Apple POWER switch ON and boot the CPS MULTIFUNCTION BASIC diskette (MCI PN 12-00215-XX).
4. Type **RUN SETUP** and press the RETURN key. This will display the Setup File Primary Menu (Figure 2-3).
5. Type **1** and the Load Setup File frame (Figure 2-4) will be displayed.
6. Type **MODEM** and press the RETURN key. A LOAD IN PROGRESS message will be displayed and the program will return to the Primary Menu (Figure 2-3). The Setup Modem file establishes the proper parameters for communicating with data base services like the Source.
7. Quit the Setup Program Primary Menu by typing **9**.
8. The monitor screen will clear and the BASIC program prompt will appear, type **PR#n** (n = the Apple peripheral slot that contains the CPS Card) and press the RETURN key.
9. Simultaneously press the CTRL and I keys.
10. Press the **H** key (for half-duplex mode) or the **F** key (full duplex mode).

The system is now operating in the Terminal Mode, the CRT should be blank. The cursor should be blinking at the top left corner of the screen.

System Dial-Up

The Apple System (terminal, keyboard and modem) are now ready to communicate with the host computer. Perform the following steps to activate the communications interface.

1. Turn on the modem and dial the phone number of the host computer communications interface.
2. Once the interface answers, a modulated tone will be transmitted over the phone line (indicates that the host computer modem is on line.) Place the phone handset into the modem (refer to the CAT Manual for additional information).
3. A sign-on message (from the remote system) should appear on the Apple screen.

You will probably be asked to enter a user identification and/or password.

NOTE: If each typed character entered from the terminal is displayed twice on the Apple CRT, modify the device parameters for full duplex operation. To do this, perform the following steps:

- a. Simultaneously press the CTRL and R keys (leave the Terminal Mode).
- b. Simultaneously press the CTRL and I keys then press the F key (re-enters the Terminal Mode in a full duplex I/O configuration.)

To terminate the link to the remote computer and return to the BASIC prompt, perform the following steps:

1. Simultaneously press the CTRL and the R keys.
2. Simultaneously press the CTRL and the X keys.
3. Enter **PR#0** and press the RETURN key.

This completes the modem hookup procedure. For additional hookup information (phantom slots, etc.) refer to Chapter 3 of this manual and the Multiple Device Hookup Section in this Chapter.

Serial Hookup Guide— CPS Card to Texas Instruments 820 Printer

To hookup the printer to the CPS Card, perform the following:

1. Turn the Apple™ rear panel POWER switch to the OFF position.
2. a. Connect a MCI 01-00156-02 cable between the CPS Card J4 connector and the MCI Matrix Switch (MCI PN 01-00243-01) as shown in Figure 2-6.
- b. Set the Matrix Switch slide switches as shown in Table 2-1.

Table 2-1 Matrix Switch Positioning

COLUMN	ROW	COLUMN	ROW
A	to 2	F	to 5
B	to 2	G	to 2
C	to 5	H	to 6
D	to 1	J	to 0
E	to 1	K	to 8

- c. Connect the MCI 01-00213-01 cable between the printer and the Matrix Switch.
- d. Set the 820 for the following configuration (refer to the TI 820 Operating manual for additional information):
 - 14 : Full duplex reverse channel ON for ready
 - 25 : 1200 baud
 - 32 : No parity check
 - 84 : No Auto LF
3. Turn the Apple POWER switch ON and boot the CPS MULTIFUNCTION BASIC diskette (MC PN 12-00215-XX).
4. Type **RUN SETUP** and press the RETURN key. This will display the Primary Menu (Figure 2-3).
5. a. Enter **1** and the Load Setup File frame (Figure 2-4) will appear.
- b. Type **SERIAL** and press the RETURN key. This will load the serial device parameters and the program will return to the Primary Menu (Figure 2-3).
6. Quit the Setup Program Primary Menu by typing **9**.
7. The Apple monitor screen will clear and the BASIC prompt will appear. Type **PR#n** (n = the Apple peripheral slot that contains the CPS Card) and press the RETURN key.

The printer is now on line and the print head should return to the left margin.

8. Type **EUREKA** and verify that the printer "has found it" (EUREKA will be printed by the TI 820).

This completes the printed hookup procedure. For additional hookup information (phantom slots, etc.) refer to Chapter 3 of this manual and the Multiple Device Hookup Section of this Chapter.

Parallel Hookup Guide— CPS Card to Anadex 8000 Printer

To hookup the terminal to the CPS Card, perform the following:

1. a. Connect the MC 01-00264-01 cable between the CPS Card J5 connector and the Anadex™ 8000 printer as shown in Figure 2-1.
- b. Place the Anadex power switch in the OFF position and remove the top cover.

Set the switches on the PC board to the following positions (refer to the Anadex Operators Manual for additional information):

DIP Switch S6
Section 2
Sections 2 - 7 OFF

DIP Switch S7 (Form Length)
Section 1 OFF Section 2 ON
Section 3 ON Section 4 OFF
Section 5 ON Sections 6 & 7 OFF

DIP Switch S8
Sections 1 - 7 OFF*

*Set Section 5 ON (LF ON) for dual mode and set the Device Parameters Menu LF OFF. Refer to the CPS Card Reference Manual for additional information.

2. Turn the Apple POWER switch ON and boot the CPS MULTIFUNCTION BASIC diskette (MCI PN 12-00215-XX).
3. Type **RUN SETUP** and press the RETURN key. This will display the Primary Menu (Figure 2-3).
4. a. Enter **1** and the Load Setup File frame (Figure 2-4) will be displayed.

NOTE: To start over, at any point during the hookup procedure (made a mistake, lost, etc.), press the RESET key. If the Applesoft prompt appears, perform step 3. If an asterisk (*) appears, type **3D0G** and press the RETURN key, then perform step 3.

- b. Type **PARALLEL** and press the RETURN key. A LOAD IN PROGRESS message will be displayed and the program will return to the Primary Menu (Figure 2-3).
5. Quit the Setup Program Primary Menu by typing **9**.
6. a. The Apple monitor screen will clear and the BASIC prompt will appear. Type **#n** (n = the Apple peripheral slot that contains the CPS Card) and press the RETURN key.
Apple output will now be routed to the printer.
- b. Type **CATALOG** and press the RETURN key. This will print a directory of the files resident on the CPS MultiFunction Basic diskette.

This completes the printer hookup procedure. For additional hookup information (phantom slots, etc.) refer to Chapter 3 of this manual and the Multiple Device Hookup Section in this Chapter.

Serial Hookup Guide— CPS Card to Model 630 Diablo Printer

To hookup the printer to the CPS Card, perform the following:

1. a. Connect the MCI 01-00299-01 cable between the CPS Card J4 connector and the Diablo™ printer as shown in Figure 2-6.
- b. Position the Diablo switches to conform to the following I/O requirements (refer to the Diablo Maintenance manual).
Baud Rate: 1200 Parity: OFF
Auto Line Feed: OFF Mode: Remote
- c. Modify the Diablo DTR signal to include the Printer Ready Status by installing a jumper plug in position A60, pins 5 and 6, on the HPR05 Circuit Card (refer to the Diablo 630 manual for additional information).

2. Turn the Apple POWER switch ON and boot the CPS MULTIFUNCTION BASIC diskette (MCI PN 12-00215-XX).
3. Type **RUN SETUP** and press the RETURN key. This will display the Primary Menu (Figure 2-3).
4. Enter **1** and the Load Setup File frame (Figure 2-4) will be displayed.

NOTE: To start over, at any point during the hookup press the RESET key. If the Applesoft prompt (bracket) appears on the monitor, perform step 3. If an asterisk appears, type **3D0G**, press the RETURN key and perform step 3.

5. Type **SERIAL** and press the RETURN key. This will load the serial (Diablo) device parameters resident on the CPS Card diskette and return to the Primary Menu (Figure 2-3).
6. Type **9** to exit the program.
7. The Apple monitor screen will clear and the BASIC prompt will appear. Type **PR#n** (n = the Apple peripheral slot that contains the CPS Card) and press the RETURN key.

The printer is now on line and the print head should return to the left margin.

8. Type **EUREKA** and verify that the printer "has found it" (EUREKA will be printed by the Diablo printer).

This completes the printer hookup procedure. For additional information (phantom slots, etc.) refer to Chapter 3 of this Multiple Device Hookup Section in this Chapter.

Serial Hookup Guide— CPS Card to C ITOH Printer

For a serial hookup of the C ITOH™ Printer to the CPS Card, perform the following:

1. a. Connect the MCI 01-00264-01 cable between the CPS Card J4 connector and the printer as shown in Figure 2-6.
 - b. Set the printer switches for the following conditions:
 - 1200 Baud
 - Auto Line Feed Off
 - Auto Paging Off
 - c. Verify that the CPS card jumpers are as shown in Figure 2-2.
2. Turn the Apple POWER switch ON and boot the CPS MULTIFUNCTION BASIC diskette (MC PN 12-00215-XX).
 3. Type **RUN SETUP** and press the RETURN key. This will display the Setup File Primary Menu (Figure 2-3).
 4. Type **1** and the Load Setup File frame (Figure 2-4) will be displayed.

NOTE: To start over, at any point during the hookup procedure (made a mistake, lost, etc.), press the RESET key. If the Applesoft prompt appears, perform step 3. If an asterisk (*) appears, type **3DOG** and press the RETURN key, then perform step 3.

5. Type **SERIAL** and press the RETURN key. A **LOAD IN PROGRESS** prompt will be displayed and the program will return to the Primary Menu (Figure 2-3).
6. Quit the Setup Program Primary Menu by typing **9**.
7. The monitor screen will clear and the BASIC program prompt will appear, type **PR#n** (n = the Apple peripheral slot that contains the CPS Card) and press the RETURN key.

The printer is now on line and the print head should return to the left margin.

8. Type **EUREKA** and verify the printer "has found it" (EUREKA will be printed by the C ITOH Printer).

This completes the printer hookup procedure. For additional hookup information (phantom slots, etc.) refer to Chapter 3 of this manual and the Multiple Device Hookup Section in this Chapter.

Multiple Device Hookup— CPS Card to CAT™ Modem & Epson™ Printer

This section provides an example of how to connect two peripheral devices to the CPS Card via the phantom slot feature. The two devices selected for this hookup example are the Cat Modem and the IDS 440 printer. The Dual Mode of operation has been selected. This mode prevents the Apple from processing data. Information is sent to the screen and to the printer.

The Phantom Slot Feature

The CPS Card supports the ability to mask out other peripheral cards and disable their operation. This allows the multiple devices on the CPS Card to be mapped to slots other than that in which the CPS Card is actually located. For additional information regarding phantom slots refer to the CPS MultiFunction Card Reference Manual.

To hookup the printer and modem, perform the following:

1. a. Connect the MC 01-00263-01 cable between the CPS J5 connector and the parallel I/O port of the IDS printer as shown in Figure 2-1.
- ok b. Connect the MCI 01-00156-01 cable between the CPS Card J4 connector and the modem as shown in Figure 2-6.
- ok c. If your CPS Card has an IDS jumper, connect the jumper as shown in Figure 2-16.
- PA If your CPS Card does not have an IDS jumper, then remove the 74LS136 IC at location U3 on the CPS Card.
- PA Install the 74LS86 IC, included with the cable assembly, in the socket at location U3. The IC has a notch (or slot) that indicates the side of the IC that faces U2. Refer to Figure 2-17 for proper IC orientation.
- U Verify that the CPS Card jumpers are set as shown in Figure 2-2.

- e. Set the printer switches to the following positions:
 - DIP Switch 4 Section 4 ON (auto line feed on for dual mode)
 - Section 5 OFF (no auto paging)
- 2. Turn the system power on (Apple, Printer, and Modem) and boot the CPS MultiFunction BASIC diskette (MCI PN 12-00215-XX).
- 3. Type **RUN SETUP** and press the RETURN key. This will display the Setup File Primary Menu (Figure 2-3).
- 4. a. Type **4** and the Set Slot Assignment frame (Figure 2-18) will be displayed.

**** SET SLOT ASSIGNMENTS ****

CURRENT ASSIGNMENTS:

# ASSIGNMENT	# ASSIGNMENT
0 - RESERVED	4 - CPS CARD
1 -	5 -
2 -	6 - DISK
3 -	7 -

**TO CHANGE ASSIGNMENTS,
FIRST SELECT SLOT.**

**ENTER SLOT # -- _____
(RETURN TO EXIT)**

Figure 2-18 Set Slot Assignments

- b. Type **5** and the Slot Assignment Slot 5 frame (Figure 2-19) will be displayed.

**** SET SLOT ASSIGNMENTS ****

CURRENT ASSIGNMENTS:

# ASSIGNMENT	# ASSIGNMENT
0 - RESERVED	4 - CPS CARD
1 -	5 -
2 -	6 - DISK
3 -	7 -

NOW SELECT DEVICE FOR SLOT 5.

**ID DEVICE
N - NO ASSIGNMENT
C - CLOCK
S - SERIAL PORT
P - PARALLEL PORT**

**SELECT DEVICE ID
(RETURN TO EXIT)**

Figure 2-19 Slot Assignment 5

- c. Type **P** to phantom select I/O port 5 for the parallel (printer) port. The program will return to the Set Slot Assignments frame (Figure 2-18).

NOTE: The slot assignments used in this example illustrate the phantom slot selection feature. Your I/O slot configuration may be different.

- d. Press the RETURN key to return to the Primary Menu (Figure 2-3).
- 5. a. Type **1** and the Load Setup File frame (Figure 2-4) will be displayed.
- b. Type **MODEM** and press the RETURN key. A LOAD IN PROGRESS prompt will be displayed and the program will return to the Primary Menu.
- 6. a. Type **3** and the program will display the Set Device Parameters Menu 1 frame (Figure 2-10).
- b. Type **5** and the program will display the Set Device Parameters Menu 2 frame (Figure 2-20).

**** SET DEVICE PARAMETERS ****

# PARAMETER	CURRENT
1 - ESCAPE CODE	CTRL-I
2 - HIGH-ORDER BIT	CLEAR
3 - AUTO LINE FEED	NO *
4 - LINE LENGTH	80
5 - PAGING	YES
	PAPER SIZE
	66
	STEP OVER
	6
6 - CONVERT LOWER = UPPER	NO
7 - CR DELAY AMOUNT	0

**SELECT PARAMETER # --
(RETURN TO EXIT)**

Figure 2-20 Set Device Parameters Menu 2

- c. Verify that the parallel parameters displayed on the monitor are identical to those shown in Figure 2-20. To modify a parameter, enter the number associated with the parameter and change its value.

*Dual mode requires the following:

- Auto Line Feed be set to NO (off) in the Set Device Parameters Menu 2.
- Printer Auto Line Feed set to ON.

- For additional information about the dual mode refer to Chapter 3.
- d. Press the RETURN key to exit the Set Device Parameters Menu.
 7. Type **9** to exit the setup file.
 8. The Apple monitor screen will clear and the BASIC prompt will appear, type **PR#n** (n = the CPS Card slot)
 9. a. Enter the Terminal Mode by simultaneously pressing the CTRL and I keys.
b. Enter the full duplex mode by pressing the F key. Half-duplex may be substituted by typing **H**.
 - c. Enter the Dual Mode by simultaneously pressing the CTRL and D keys.
 10. a. Turn on the modem and dial the phone number of the host computer communications interface.
b. When the interface answers a modulated tone will be transmitted over the phone line. When this occurs place the phone handset into the modem (refer to the CAT manual for additional information.)
c. A sign-on message (from the remote system) will appear on the monitor.
- This completes the multiple device hookup example.

VISIDEX Clock Patch

Using Apple Computer's FID program transfer the file VISIO.8 to the Visidex 1.01 diskette. After completion, boot up Visidex and when the clock slot is asked for, type in Slot #8. Our VISIO.8 patch will automatically find the CPS clock.

Chapter 3 The CPS Card Diskette

The CPS Card diskette contains several useful programs. The most important of these, the Setup program is used for initializing the CPS Card and setting up default parameters for the devices you will use. The Analog Clock II program is a demonstration that draws a picture of a real, time-keeping clock on the screen. The CPS Lister program prints your Applesoft programs in a structured format, with the date and time printed at the top of each page. The Clock and CPS Slot Finder finds the slot that the CPS or Apple clock resides (CPS Clock has precedence.) The Date and Time programs display the date and time information on the Apple monitor.

In addition to the programs on the CPS Card diskette, there are some special files called Setup files. Each Setup file contains parameter information for a specific peripheral device. These files can easily be read into the CPS Card memory when you want to change device configurations.

Also included on the diskette are two BASIC subroutines that can be included in your Applesoft and integer BASIC programs.

All the programs provided on the CPS Card diskette will run if your Apple is equipped with

- at least 32K RAM memory
- a ROM version of Applesoft

The Setup and CPS Lister programs will work without a ROM version Applesoft if your Apple has at least 48K RAM memory. The Analog Clock II program, however, will not work without ROM Applesoft.

This chapter will be most effective if you follow along with the programs being described as you read. If your CPS Card is not completely installed, follow the directions in Chapter 1, Installation, before continuing with this section.

The Setup Program

Most peripheral devices require special parameters in order to work with your Apple. The Setup program is used to establish and store a set of parameters in the CPS Card battery-backed memory. The parameter information will remain in CPS Card memory even if you press RESET or turn off the Apple's power. This information can also be stored on

diskette in a Setup file for later use.

Running the Program

Boot your working copy of the CPS Card diskette. A title screen with a list of the programs on the diskette will appear. To run the Setup program, type

RUN SETUP

and press the RETURN key. A title screen will announce the program, and the message

READING PARAMETERS . . .

will appear. In a few seconds the parameters will be loaded and the Primary Menu (Figure 2-3) will appear. To select one of the ten options, type the number to the left of the option you wish to choose. You don't need to press the RETURN key.

NOTE: If the diskette won't boot, or error messages are displayed, see Appendix C, If Your Diskette Doesn't Work.

Cataloging the Diskette

The Setup program allows you to catalog your diskette from the Primary Menu. Choose option 0, and the diskette in the most recently accessed drive will be cataloged.

The text files with the prefix "SETUP." are Setup files. When you have finished looking at the catalog, press the space bar.

Loading a Setup File

To load a Setup file, use option 1 on the Primary Menu, Load Setup File. A new screen display will appear, indicating that you are to type the name of the file you wish to load. Notice that the SETUP. prefix is supplied for you. If the diskette containing that file is not in the most recently accessed drive, you must indicate slot and drive numbers. Use the standard DOS conventions. For example, to load a file listed in the catalog as "SETUP. DIABLO" which is in drive 2 of the disk controller plugged into slot #5, type

DIABLO,S5,D2

If you make a typing error, use the left-pointing arrow key to erase one character at a time, or erase the entire line by pressing CTRL-X. Then you can retype the file name correctly. When the file name is correct, press the RETURN key. The parameters in that file will be

read into the CPS Card battery-backed memory.

These parameters will become the "default" parameters. That is, they will be used unless you change them or load the parameters from another file.

If the file you specified is not on the diskette, you will get a DOS error message with an error code number. Pressing the space bar will return the Primary Menu to the screen. (Your DOS manual has a list of error codes and their meanings.)

NOTE: If you use non-existent slot and drive designations, or if you leave the drive door open when you are attempting to access the diskette, you will get a fatal DOS error (code 8). To recover, press the RESET key and then reboot the diskette.

Saving a Setup File

When the parameters have been set to your specifications, you can save them on diskette as a Setup file for use at a later time. Choose option 2, Save Setup File, from the Primary Menu. Then type the name under which you wish to save the new Setup file. Notice that the SETUP. prefix is supplied for you. File names have the following limitations:

- Any characters except commas and CTRL characters can be used in a file name.
- The file name can be up to 24 characters long, including spaces and punctuation, but excluding the SETUP. prefix. A 24 character name plus the 6 characters in the SETUP. prefix add up to 30 characters, the limit for DOS. If you try to use a longer file name, DOS will truncate it to 30 characters.
- If you are saving the file onto a diskette that is not in the most recently accessed drive, you must specify the correct slot and drive numbers. Use the standard DOS slot and drive conventions.

As with the Load Setup File option, you can erase one character at a time with the left-pointing arrow key, or you can erase the entire line with CTRL-X. When the file name is the way you want it, press the RETURN key to save the Setup file on your diskette.

Setting the Device Parameters

Option 3, Set Device Parameters, lets you address specific types of devices. When you

choose this option, a new menu appears on the screen.

If you do not plan to use a device associated with one of the options on this menu, skip that section. For example, if you are not using a parallel output device, skip the section called Parallel Output.

SERIAL INPUT

If you are using a serial input device, you will need to set serial input parameters. Choose option 2, Serial Input, from the Device Parameters Menu. The Serial Input menu that appears on the screen has two items.

Option 1, Convert Lower to Upper, allows you to convert lower case letters that are being input to the CPS Card to upper case letters for display. Type a **Y** for "yes," an **N** for "no," or press RETURN to go back to the Serial Input Menu without changing anything.

Option 2, Echo Character, lets you choose whether or not to "echo" the character input back to the sender. After choosing the Echo Character option, type a **Y** or **N**, or press RETURN to go back to the Serial Input Menu without changing this parameter.

From the Serial Output Menu, press RETURN to redisplay the Device Parameters Menu.

SERIAL OUTPUT

If you are planning to use a serial output device with your CPS Card, you must set serial output parameters. From the Device Parameters Menu choose option 3, and the Serial Output Menu will appear on the screen. The current serial output settings are listed to the right of the menu options.

Option 1 on the Serial Output Menu allows you to choose the character that will initiate an Escape Code. (See Chapter 4, The Commands, for more information on Escape Codes.) You have a choice of CTRL-I or CTRL-A, or you can press RETURN to indicate no change.

Option 2 lets you clear or set the high-order bit (bit 7) in each byte of information. Choose this item, and type a **C** for clear or an **S** for set, depending on what your output device expects. If you don't wish to change the current setting, press RETURN.

Option 3 lets you specify auto line feeds after each carriage return. After you choose this option, type a **Y** for yes or an **N** for no, or press

RETURN to indicate no change.

Option 4, Line Length, allows you to specify the maximum number of characters that can be printed per line. After choosing option 4, type the number of characters you want per line (1 to 255), and press RETURN.

Option 5, Paging, lets you choose whether to use the automatic paging provided by the CPS Card. Choose the Paging option from the Serial Output Menu. Then type a **Y** for "yes," an **N** for "no," or press RETURN to redisplay the Serial Output Menu.

If you choose to use automatic paging you will be asked to specify the paper size as a number of lines. The paper size can be any number from 1 to 255. (66 is usual for an 11 inch page.) Type the number and press RETURN. You will then be asked to specify the number of lines required to step over the perforation. This number must be less than the number of lines given for the paper size. For example, if you entered a paper size of 66 lines, you will be asked to type a number from 0 to 65. (6 is usual for an 11 inch page.) Type the number of lines you wish to step over, and press RETURN. The Serial Output Menu will return to the screen.

Option 6 lets you choose whether to convert outgoing lower case letters to upper case. After choosing this option, type a **Y** or **N** for yes or no, press RETURN for no change.

Option 7 lets you set a carriage return delay in units of 10 milliseconds. You may specify a delay of from 0 to 255 units (2.55 seconds). After choosing this option, type the desired delay and press the RETURN key.

When the serial output parameters are as you want them, (look at the column labelled CURRENT to check) press RETURN and the Device Parameters Menu will reappear.

SERIAL CONTROL

Serial control parameters affect both serial input and serial output. Choose option 4 from the Device Parameters Menu to display the Serial Control Menu.

Option 1 on the Serial Control Menu lets you set the baud rate for your serial device. When you choose this item, a list of the available baud rates will appear. Choose the baud rate that is appropriate for your serial device by typing an ID letter, or press RETURN to leave

the baud rate unchanged.

Option 2 allows you to change the parity setting for your serial device. (Parity is a way of verifying whether characters received match up with the characters that were sent.) You may set an odd or an even parity, or you may choose to use no parity, depending on what your serial device expects. After choosing option 2, choose the parity setting you wish, or press RETURN to leave the parity unchanged.

Option 3 allows you to change the number of bits used to determine ASCII characters. The allowable range is from 5 to 8 bits. After choosing option 3, type a number from 5 to 8, or press RETURN to leave the character length unchanged.

Option 4 lets you choose one of three possible stop bit settings. After choosing this option, type the ID letter indicated for the setting you wish, or press RETURN if you don't wish to change the stop bit setting.

Check the CURRENT column on the Serial Control Menu to determine whether the serial control parameters are the way you want them. If so, press the RETURN key to go back to the Device Parameters Menu.

PARALLEL OUTPUT

If you are using a parallel device with your CPS Card you will need to set parallel output parameters. The parallel output parameters are exactly the same as the serial output parameters except that they affect the parallel device. Choose option 5 from the Device Parameters Menu and modify the parallel output parameters just as you did the serial output parameters.

Setting Slot Assignments, or Phantom Slots

A useful and unusual feature of the Multi-Function Card is its ability to assign devices to "phantom" slots. With the phantom slot capability, you can plug the CPS Card into one slot and assign its three devices to three other slots. In this way you can switch from one CPS Card device to another simply by indicating the slot to which it is assigned. This feature allows you to use slot dependent software without reconfiguring your system.

NOTE: If your software isn't particular about what slots peripherals are in, you may find it easier to forego the phantom slot option.

When you choose option 4, Set Slot Assignments, from the Primary Menu, the Slot Assignments Menu will appear on the screen. Notice that slot #0 is marked "RESERVED," the slots in which your disk drives are plugged are marked "DISK" and the slot in which your CPS Card is plugged is marked "CPS CARD." These slots have special significance, which will be explained below.

You can assign the CPS Card devices to any slot except

- slot #0,
- the CPS Card slot,
- the slot in which your only remaining disk drive is plugged.

To assign a CPS Card device to a phantom slot, first select the slot number. For example, to assign the serial port to slot #3, type a **3**. A list of the devices that can be assigned will appear on the screen below the list of current slot assignments. For example, to assign the serial port, type an **S**, the ID letter for the serial port. To de-assign a slot previously dedicated to a CPS device, select **N** (no assignment).

Notice that one CPS Card device can be assigned to more than one slot. For example, you could assign the serial port to both slot #3 and slot #4. Then whenever slot #3 or #4 was accessed, the serial port would be activated. This feature is handy if you are using two or more software packages, each of which assumes a certain peripheral to be in a different slot.

Slots that have peripheral cards plugged into them can also have CPS Card devices assigned to them. However, special commands must be used to access the peripheral card that is actually plugged into the slot. For now, don't assign CPS Card devices to slots that are already occupied. If you wish to do so later, see the section called "Phantom Slots" in Chapter 4.

You can assign devices to slots containing disk drives as long as at least one disk drive is not assigned. As a protection against accidentally assigning your disk slots away, you will be asked for verification if you attempt to assign a CPS device to a slot that contains a disk drive.

PHANTOM SLOT CONFLICTS

The CPS Card was designed to alleviate the need for switching peripheral cards around

for software compatibility. If you are careless when indulging in "card swapping," you can end up with your CPS Card plugged into a phantom slot. For example, you could assign the CPS Card serial port to slot #3, then turn off your Apple and plug the CPS Card into slot #3. If this happens, the slot assignment will be automatically deleted when you run the Setup program.

If you load a Setup file that has slot assignment conflicts with the setup information currently in the CPS Card memory, the Setup program will give you two choices:

- Eliminate all the conflicting assignments, in which case the remaining parameters in the Setup file will be loaded.
- Cancel the attempted load, in which case the parameters in the CPS Card memory will be left as they were before the file was loaded.

Type an **E** for Eliminate or a **C** for Cancel. When the slot assignments are the way you want them, press the RETURN key to redisplay the Primary Menu on the screen. The slot assignments you made were written into the CPS Card memory as they were assigned.

Setting the Default Input Device

The default input device is the one that is automatically used when you turn the CPS Card on for input. The Setup program lets you choose which of the allowed devices will be used as the default. To change the default input device, choose option 6 from the Primary Menu. The Input Device Menu will appear on the screen.

From this menu you can choose either S for serial or C for clock. Type the letter of your choice, or, if you don't wish to change the default input device after all, press the RETURN key to redisplay back to the Primary Menu.

Setting the Default Output Device

The default output device is the one that is automatically used when you turn the CPS Card on for output. The CPS Card can output to either a serial device or a parallel device. The Setup program lets you specify which type of output device you wish to use as a default.

Choose the seventh option on the Primary Menu, and the Output Device Menu will appear on the screen. Choose S for serial, P for

parallel, or, if you don't wish to change the default output device, press the RETURN key.

Displaying or Printing the Parameters

The Setup program lets you double check at a glance the parameters you have set, by allowing you to display them on the screen or print them on paper. To display or print the parameters, choose option 8, from the Primary Menu.

If you want to display the parameters on the screen, type a 0 when you are asked to type a slot number. The parameters will begin to appear on the video screen. When you have looked at the first screenful of information, press the space bar to display the next screen. If you want to print the parameters on paper, one of the following conditions must be met:

- your printer must be the default output device (as set in the Setup program), or
- the printer must be assigned to a phantom slot.

If the printer is the default output device, type the slot number of the CPS Card. If the printer is assigned to a phantom slot, type the phantom slot number, and printing will begin.

If you type the number of a slot that doesn't have a printer associated with it, the program will "hang," and you will have to RESET and reboot to recover. The parameters you have set were automatically stored in the CPS Card memory as you set them, so they will not be lost when you RESET.

When all the parameters have been displayed or printed, the Primary Menu will reappear on the screen.

Exiting the Program

When you are finished with the Setup program, choose option 9, Exit, from the Primary Menu. That's all you have to do. The parameters you have set are already stored in the CPS Card memory.

Clock Programs

The following section contains information on the clock programs resident on the CPS Card diskette. Set the time of the CPS Card Clock before using any of the sample clock programs.

Setting the Time

As with most clocks, the CPS Card clock must be set to the correct time before it can be used.

To set the clock time perform the following steps:

1. Boot the working copy of the CPS Card diskette and type **RUN SETUP** and press the RETURN key. This will display the CPS Setup Primary Menu (Figure 2-3).
2. Select Option 3, (SET DEVICE PARAMETERS). This will display the Set Device Parameters menu as shown in Figure 3-1.

```

** SET DEVICE PARAMETERS **
** GROUP SELECTION **
# GROUP
1 - CLOCK INPUT
2 - SERIAL INPUT
3 - SERIAL OUTPUT
4 - SERIAL OUTPUT
5 - SERIAL CONTROL
6 - PARALLEL OUTPUT
SELECT GROUP # -- _____
(RETURN TO EXIT)
```

Figure 3-1 Device Parameters Menu

3. Enter 1 (Clock Input), this will display the Clock Input Format Menu shown in Figure 3-2.

```

** SET DEVICE PARAMETERS **
** CLOCK INPUT FORMAT **
THERE ARE TWO POSSIBLE TIME STRING
INPUT FORMATS. FORMAT 1 IS COMPAT-
IBLE WITH THE MCI CLOCK.
# FORMAT
1 - MM/DD HH:MM;SS.000
2 - DAY MM/DD/YY HH:MM;SS
(THE CURRENT CHOICE IS X)
SELECT FORMAT # -- _____
(RETURN TO EXIT)
```

Figure 3-2 Clock Input Format

- Select the format type and enter the number.

The CPS (real-time) Clock provides two time string formats:

Format number 1 is the same as the Mountain Computer Clock (part # 01-00229-XX) format. The CPS Card clock does not provide resolution in the millisecond range, its resolution is in seconds. To provide compatibility with existing MCI Clock software the CPS Clock supplies zeroes for the millisecond digits as shown below.

MM/DD HH;MM;SS.000
07 / 01 09 ; 24 ; 31.000

Format number 2 gives the same information as format number 1, plus the day of the week and the year.

DAY MM/DD/YY HH;MM;SS
3 07 / 01 / 81 09 ; 24 ; 31

The day of the week is given as a number from 0 to 6, where 0 is Sunday, 1 is Monday, etc.

- Once the format is selected press the RETURN key to return to the Device Parameters Menu (Figure 3-1).
- Press the RETURN key to return the program to the Device Parameters Menu (Figure 3-2.)
- Press the RETURN key again to return to the Primary Menu (Figure 2-3.)
- Enter 5 (Set the Time), this will display the Date/Time Entry Frame (Figure 3-3.)

**** SET THE TIME ****

ENTER THE DATE AND TIME IN THE FORMAT SHOWN BELOW. THEN PRESS RETURN TO VERIFY YOUR ENTRY.

ENTER DATE & TIME— _____
 19 _____ : _____ M
EXAMPLE: OCT 3, 1984 12:30 PM

(PRESS RETURN FOR VERIFICATION)

Figure 3-3 Date/Time Entry Frame

- Enter the date and time and press the RETURN key.

NOTE: Enter the date and time at which you wish to start the clock. Use the example on the screen as a guide to the correct format. You should enter a time that is a few seconds from now so you'll have time to check your typing and verify your entry before you instruct the clock to begin keeping time.

The CPS Card clock recognizes 12:00 PM as noon and 12:00 AM as midnight. The clock starts the first minute of the new day at 12:00 AM. If you set the clock at 12:00 AM, be sure to enter the date for that morning, not the previous evening.

The arrow keys can be used to edit your entry. They move the cursor to the left and right. You can move the cursor to the mistyped character with the arrow keys, and then re-type it.

When the entry is correct, press the RETURN key to verify it. If you have entered an illegal character, (for example, if you entered a number instead of the name of the month) the cursor will move to the invalid character and wait for you to retype the character and press the RETURN key again. If you press RETURN without correcting the illegal character, the Primary Menu will be redisplayed.

When the entry has been verified you will be instructed to press RETURN to start the clock, or to press CTRL-P to reenter the time. If you want to start the clock, wait until the actual time is the same as the time you set. Then press RETURN. If you want to enter a new time, or quit without setting the time, press CTRL-P. You can then either enter a new time or press RETURN to go back to the Primary Menu.

- Select option 9 (EXIT) to exit the setup program.

Reading the Time

For a quick look at the time, on the monitor, type the following (in BASIC):

IN#n where n = the slot number of the CPS Card or the CPS Clock phantom slot number.

The time will continue to be displayed on the monitor until the RESET key is pressed. This assumes that the CPS Clock has been set as the default input device (via the Setup Menu.)

* CTRL-LETTER indicates that the given key is depressed simultaneously with the CTRL key.

Program Examples

The CPS Card Diskette has two sample programs and one exec file that demonstrate CPS Clock capabilities. These programs are Date And Time and Time String; the exec file is Clock And CPS Slot Finder. (Print a listing of these programs and examine their content.)

DATE AND TIME

This program is written in Applesoft BASIC. Regardless of the format selected for the clock it will use format 2 (refer to Figure 3-2 for additional information.)

To run the program type:

RUN DATE AND TIME

and press the RETURN key.

The date and time information will appear in the center of the monitor as shown below.

FRIDAY JANUARY 13, 1984

8:52:03 AM

PRESS ANY KEY TO STOP _

CPS SLOT FINDER

This program cannot be loaded and listed as a BASIC program is listed. To list a text file perform the following:

1. From the BASIC environment type:

NEW

and press the RETURN key.

2. Type

EXEC· CPS SLOT FINDER

and press the RETURN key. This will load the program.

The program may now be displayed on the monitor or printed using the LIST command.

This subroutine looks for the CPS Card and the MCI Clock Card. If it finds the CPS Card it sets the variable SLOT equal to the slot the CPS Card is resident in. It also sets the variable CPS equal to 1. If no CPS Card is found, it will search for the MCI Clock Card and return the slot number it resides in. If the MCI Clock is found it will set the variable CPS equal to 0. If neither card is found, the subroutine will set the value of SLOT equal to zero.

NOTE: Refer to the section "The CPS Slot Finder" in this chapter for additional information.

TIME STRING

This program demonstrates the use of the CPS Slot Finder text file. The program initialization is similar to the Date and Time program. It checks for the CPS Card Clock. If absent, the program is terminated.

The Analog Clock II Program

This program draws a picture of a clock face on your video screen, but that's not all. The clock actually keeps accurate time with hands that really move.

To run the Analog Clock II program, type

RUN ANALOG CLOCK II

and press RETURN. In a few seconds the clock will appear on the screen. When you wish to leave the program, press the key marked ESC.

NOTE: If you accidentally press CTRL-C to end the program, your Apple will be left in an unpredictable state. You will have to reboot to recover.

The CPS Lister Program

The CPS Lister program allows you to make formatted listings of Applesoft programs. The listing will be conveniently spaced, the date and time will be printed at the top of each page, and each page will be numbered sequentially.

The default parameters that are stored on the CPS Card will be used. If you have not set automatic paging in the Setup program, the date and time will be printed at the top of the first page, and the listing will be continuous with no page breaks. To run the program, type

RUN CPS LISTER

and press RETURN.

When you are asked whether you have a serial or parallel printer, type **S** or **P**, as indicated on the screen.

Next you are asked to enter the name of the file you wish to list. If you do not specify slot and drive numbers, the most recently accessed disk drive will be used. Use the standard DOS conventions for specifying slot and drive numbers. After typing the file name, press RETURN.

When prompted, insert the diskette in the drive you specified or the drive that was most

recently accessed. Make sure your printer is turned on and the top of form is properly set.

When everything is ready, press the space bar. In a moment the program listing will begin to print on the screen and printer simultaneously.

Once the printing has started, you can abort it by pressing

CTRL-C

from the keyboard, or you can cause the listing to pause temporarily by pressing

CTRL-S

To restart the listing after a CTRL-S, press the space bar. When the listing is finished, the program that was listed is in the Apple's memory.

Some Useful Subroutines

Two subroutines that can be EXECed into your BASIC programs are included on the CPS Card diskette. Both of these subroutines work in Integer and Applesoft BASIC. (One of them, the Setup File Loader, requires one small modification to work with Integer BASIC. This will be described later.)

The CPS Slot Finder

The CPS Slot Finder Subroutine locates the CPS Card slot. Load the program in which you wish to incorporate the CPS Slot Finder subroutine. Then put the CPS Card diskette in the most recently accessed disk drive, and type

EXEC CPS SLOT FINDER

The Slot Finder sets the variable SLOT to the CPS Card slot number. Make sure your program does not use a variable beginning with the letters SL. If there is no CPS Card in your Apple, SLOT will be set to 0. To access this subroutine, use a

GOSUB 29000

command.

The Setup File Loader

The Setup File Loader subroutine loads Setup files into the CPS Card memory. This subroutine has its own slot finder. Load the BASIC program into which you wish to incorporate the Setup File Loader subroutine. Then put the CPS Card diskette into the most recently accessed disk drive, and type

EXEC SETUP FILE LOADER

If you are using the File Loader in an Integer BASIC program, a message on the screen will inform you that you must change line 28040. Since the CHR\$ function is not ordinarily available in Integer BASIC, change the CHR\$(4) on that line to a "CTRL-D".

Before you use the Setup File Loader subroutine, you must add a line to your program. This line must set the variable NA\$ to the Setup file name you wish to load, *minus the SETUP. prefix*. For example, if you wanted to load the Setup file for the Diablo printer (SETUP.DIABLO) you would set

NA\$ = "DIABLO"

To load a Setup file with the Setup File Loader, use a

GOSUB 28000

in your BASIC program.

Chapter 4

Software Commands

The CPS Card has its own program stored in ROM (Read Only Memory). The program in ROM processes information travelling between the computer and the attached peripheral device. A number of software commands with which to control peripheral devices are also provided.

There are four levels of CPS Card commands.

- Initialization lets you access peripheral slots.
- Command Sequences provide general CPS control.
- Escape Codes control some of the device parameters.
- Terminal Mode Modifiers are special commands used exclusively in Terminal Mode.

These commands must be used in descending order. For example, you cannot give a Command Sequence before initializing the CPS Card. The following illustration shows the order in which CPS Card commands can be used.

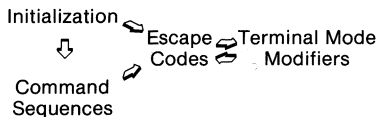

Initialization

Apple peripherals must be initialized before they can be used. This holds true for CPS Card devices too. Initialization procedures vary slightly, depending on your system configuration.

The BASIC PR# and IN# commands initialize CPS Card devices. These commands can be used in immediate execution mode, or from a BASIC program.

To initialize the CPS Card default output device, type

PR#n

where n is the slot number of the CPS Card. To initialize an output device assigned to a phantom slot, let n be the phantom slot number.

To initialize a default input device attached to the CPS Card, type

IN#n

where n is the slot number of the CPS Card. To initialize an input device assigned to a phantom slot, let n be the phantom slot number.

Command Sequences

Command Sequences have two main functions. They are used to temporarily change the current input and output devices, and to enable or disable the phantom slot option. The default input and output devices are not actually changed by Command Sequences. Only the current devices are affected. A PR# or IN# command will reestablish the default devices as the current devices.

There is also a Command Sequence command to stop processing Command Sequences. This allows you to send Command Sequence letters as regular characters.

Command Sequences must be sent to the CPS Card, not to one of the phantom slots. The CPS Card must be initialized for output (with a PR# command) before these commands can be used.

Command Sequences are activated with a special control character, CTRL-W, followed by one or more command characters. These commands can be given from a BASIC program, or from an input device.

There are eight command characters available for Command Sequences. Below you'll find a list of them:

- S — stops processing Command Sequences.
- A — switches the current input device to the clock, and allows output through the CPS Card.
- C — switches the current input device to the clock, and suppresses output through the CPS Card.
- I — switches the current input device to the serial port.
- O — switches the current output device to the serial port.
- P — switches the current output device to the parallel port.
- D — disables the currently established phantom slots.

E — enables the currently established phantom slots

These commands can be used in any combination or order. However, some of them counteract each other. You must pay attention to the order in which you give these commands to produce the effect you desire.

In a BASIC Program

Command Sequences can be incorporated into either Integer or Applesoft BASIC programs. In an Integer BASIC program, simply put the CTRL-W between quotes. For example, to set input to serial and output to parallel, you would use Integer BASIC statements like this:

```
40 W$ = " ": REM CTRL W IN QUOTES
50 PRINT W$; "IP"
```

NOTE: The CTRL-W between the quotes in line 40 doesn't show up on your screen.

If you are using Applesoft BASIC, you can use the Applesoft CHR\$ function to eliminate the need for invisible CTRL characters. (If you are not familiar with the CHR\$ function, see the Applesoft Reference Manual.) For example, the Command Sequence illustrated above could be accomplished with these Applesoft program lines:

```
70 W$ = CHR$(23):REM CTRL-W
80 PRINT W$;"IP"
```

NOTE: 23 is the ASCII equivalent to CTRL-W. (There's an ASCII table in the Applesoft Reference Manual.)

To use the Command Sequences to their greatest advantage, you should be aware of the relationships between the commands and the initialization process.

Initializing Both Input and Output

You can initialize a device for both input and output by using a PR# command and an IN# command consecutively. However, beware of putting Command Sequences between the PR# and IN# commands. If you do this, the commands given in the Command Sequence will be executed, but then disregarded as soon as the second initialization command is issued.

For example, if the CPS Card is plugged into slot #3, the following Applesoft BASIC pro-

gram segment will switch the current input device to the clock:

```
10 D$ = CHR$(4)
20 W$ = CHR$(23)
30 PRINT D$; "PR#3"
40 PRINT D$; "IN#3"
50 PRINT W$;"C"
```

The following program segment contains all the same commands, but it will not work.

```
10 D$ = CHR$(4)
20 W$ = CHR$(23)
30 PRINT D$; "PR#3"
40 PRINT W$; "C"
50 PRINT D$;"IN#3"
```

Here's why it doesn't work. The statement on line 30, PR#3, initializes the CPS Card for output. The command sequence on line 40 causes the CPS Card to switch the current input device to the clock. So far, so good. However, the IN#3 command on line 50 re-initializes the CPS Card, resetting the current input device to the default.

The Clock

The CPS Card clock is an input device. Consequently, you must use an IN# command to initialize it. However, if you wish to use Command Sequences with the clock, you must use the PR# command also.

There are two Command Sequence commands that control the CPS Card clock. The A command switches the current input device to the clock and, at the same time, allows output to another device through the CPS Card. The C command also switches the current input device to the clock, but suppresses all output. If the clock is the default input device, output is suppressed as if the C command was used.

The time is input to a "time string" it will reflect the format you specified in the Setup program. To retrieve the time string, first initialize the clock, and then use an INPUT statement with a string variable. For example, if the clock was the current input device, and the CPS Card was plugged into slot #3, the following program statement would retrieve the time:

APPLESOFT BASIC

```
50 D$ = CHR$(4)
60 PRINT D$; "IN#3"
65 PRINT D$; "PR#3"
70 INPUT T$
80 PRINT D$; "PR#0"
90 PRINT D$; "IN#0"
```

INTEGER BASIC

```
50 D$ = " ":REM CTRL-D IN QUOTES
60 PRINT D$; "IN#3"
65 PRINT D$; "PR#3"
70 INPUT " ", T$
80 PRINT D$; "PR#0"
90 PRINT D$; "IN#0"
```

The Serial Port

You can initialize the serial port for input, output, or both. To initialize the serial port for input, you must use the IN# command. To initialize the serial port for output, you must use the PR# command.

Once the CPS Card is initialized, you can temporarily switch the current input or output device to the serial port with Command Sequences. The I command sets the current input device to the serial port. The O command sets the current output device to the serial port.

Parallel Port

The parallel port can only be used for output. To activate the parallel port, initialize with a PR# command. If the current output device is the serial port, you can switch to the parallel port with a Command Sequence command. The P command accomplishes this.

Phantom Slots

If you used the Setup program to assign devices to phantom slots, you can use Command Sequence commands to temporarily disable or enable them. The D command disables phantom slots; it will allow the use of devices that physically reside in the slots rather than the CPS devices previously assigned. The E command re-enables them.

Pressing the RESET key, turning off the power, or running the Setup program will also re-enable the phantom slots.

NOTE: Assigning the parallel port to slot #3 and then issuing an IN#3 command will produce unpredictable results because the parallel port is for output only.

CAUTION: Once you have assigned phantom slot numbers to CPS devices via the Set Slot Assignment Menu, peripheral cards installed in those physical slot locations may be ignored.

If via keyboard or program you try to access these other peripherals, you may cause one of the three following malfunctions to occur:

1. The system will hang.
2. A "Cannot find Device" error message will be generated.
3. The phantom device will be activated.

Four methods to de-assign a phantom slot are as follows:

TEMPORARY

Enter the following Applesoft Phantom Slot Deselect program.

```
10 D$ = CHR$(4):W$ = CHR$(23)
20 PRINT D$; "PR#n":REM
   n = CPS slot#
30 PRINT W$; "D"
40 PRINT D$; "PR#0"
50 END
```

Run this program (save it on diskette for future use.) To return to the phantom slot configuration press the RESET button.

PERMANENT

(A) Move the device to an unassigned slot.

OR

(B) Perform the following procedure.

1. Press the RESET button.
2. Boot the CPS diskette.
3. Run the Setup Program and select the Slot Assignments Menu.
4. Enter the slot number of the conflicting device.
5. Enter "N" and leave the Setup Program.

Escape Codes

While Command Sequences are commands to the CPS Card in general, Escape Codes are device specific commands. The device that is

currently active is effected by the Escape Codes. Escape Codes are activated with a control character. Only one Escape Code command letter is allowed at a time, and spaces are not allowed.

There are two control characters that can be used in Escape Code commands, CTRL-I and CTRL-A. You can choose which of these you wish to use. The default control character is the one you selected with the Setup program. The default will be re-established when you re-initialize the CPS Card. For this discussion we have assumed you are using CTRL-I.

Here is a list of the available Escape Codes:

- C — clear high-order bit
- S — set high order bit
- E — enable auto linefeed after RETURN
- K — disable auto linefeed after RETURN
- F — enter full duplex terminal mode
- H — enter half duplex terminal mode
- L — pass lower case letters unmodified
- N — ignored
- U — convert lower case letters to upper case
- R — regular video display mode
- D — special inverse video display mode (upper case in inverse)
- O — turn off video output
- V — turn on video output
- T — enable absolute tabbing
- B — return to regular tabbing
- CTRL-A — change control character to A
- CTRL-I — change control character to I

NOTE: The escape code N is a NOP (pronounced no op) character. This character doesn't change any parameters, nor does it cause an illegal character error.

Escape Codes can be typed from the keyboard, or they can be used from within an Applesoft or Integer BASIC program by way of PRINT statements. The Applesoft CHR\$ function can be used in the same way it is used for Command Sequences. For example, to set the high-order bit from an Applesoft program, use a program segment like

```
10 I$ = CHR$(9)
20 PRINT I$;"S";
```

NOTE: When typing escape codes from the keyboard you may type CTRL-X before pressing the RETURN key to avoid a syntax error message.

The Printing Equipment

The line length for your printer must be established in the Setup program. A line length command embedded in a program will not work. The command commonly used for setting line lengths for Apple parallel printers is

CTRL-I 80 N

(where 80 can be any digit or digits allowed by your printer), will be ignored when you are using the CPS Card.

Other CTRL-I commands will be rejected and cause the Apple to beep, or will behave as Escape Codes. If your program uses CTRL-I commands, use the CTRL-I CTRL-A command to change the escape character to CTRL-A to permit program listing.

The High-Order Bit

You were given the opportunity to set or clear the high-order bit with the Setup program. The condition you specified in the program is the default. You can temporarily change this condition with an Escape Code.

To set the high-order bit, use CTRL-I S. To clear the high-order bit, use CTRL-I C.

Auto Line Feed After RETURN

The condition you set in the Setup program is the default condition. To temporarily change it, use an Escape Code. To enable auto line feed after each carriage return, use CTRL-I E. To disable this feature, use CTRL-I K.

Lower to Upper Case

The default condition for lower case processing is as you specified in the Setup program. You can use Escape Codes to temporarily change this condition. CTRL-I L causes lower case letters to be passed to the printer unmodified. CTRL-I U causes all lower case letters to be converted to upper case.

Video Output On or Off

The default video output setting is on. To temporarily change the video output setting to off, use the Escape Code, CTRL-I O. To turn the video output back on, use CTRL-I V.

Ordinary or Special Display

The special inverse display mode prints lower case letters as normal capital letters and prints

upper case letters in inverse (black on a white background).

The ordinary display mode (all upper case, no inverse) is the way the Apple usually displays text. You can change to the special display mode with CTRL-I D and change back to ordinary display mode with CTRL-I R.

Change Escape Code CTRL Character

There are two allowable Escape Code CTRL characters: A and I. The Setup program lets you specify the default Escape Code CTRL character. You can temporarily change the CTRL character by using another Escape Code.

To change the Escape Code CTRL character from CTRL-A to CTRL-I, type

CTRL-A CTRL-I

Similarly, to change the CTRL character from I to A, type

CTRL-I CTRL-A

Tabbing

When you are using the CPS Card to print with a line length of 40 or fewer characters, all tabbing will work just as it does on the Apple screen. The CPS Card provides two tabbing modes designed to minimize the extra complications that occur with line lengths greater than 40 characters.

The default tabbing mode supports most kinds of tabbing available on the Apple. The only kind of tabbing that it doesn't support is the Applesoft TAB function when the line length exceeds 40 characters. Instead of tabbing to the specified column number, as is usual, in the default tabbing mode the TAB function will simply tab a number of spaces equal to the number in parenthesis. For example, if the Applesoft TAB function was working normally, and the line length was 42 or greater, the Applesoft statement

```
PRINT A; TAB(21); B; TAB(41); C
```

would print the letters A, B, and C leaving twenty spaces between each letter. However, in default tabbing mode the same statement would print the letter A, tab 21 spaces, print the letter B, tab 41 spaces, and then print the letter C.

NOTE: The Integer BASIC TAB function works like the Applesoft HTAB function.

The Absolute tabbing mode allows absolute tabbing with the Applesoft TAB function, even with the line lengths of greater than 40 characters. However, in this mode, program listings will not exceed a 40 character width, and the comma tabbing function (see the Applesoft Tutorial for more information on comma tabbing) will cause a carriage return after 40 characters, just as on the Apple screen.

To invoke Absolute tabbing mode, use CTRL-I T

To go back to the default tabbing mode, use CTRL-I B

These commands are most effective when used from BASIC program PRINT statements. If you try to use CTRL-I T from the keyboard, the characters you type will appear normally, but the cursor will behave unpredictably if the command is followed by more than 40 characters.

If you wish to use absolute tabbing but don't wish to use Absolute tabbing mode, or if you wish to use absolute tabbing in Integer BASIC, you can use the following POKE statement:

```
POKE 36, n
```

where n is the column number to which you wish to tab, minus 1.

NOTE: The column positions, as numbered by the TAB function, are numbered from 1. However, the column positions recognized by the POKE command are numbered from 0.

Printing, Typing and the Video Display

After printing has been invoked with a PR# command to your printer, entering commands (for example, the LIST command) from the Apple keyboard may cause video display anomalies as follows:

- The default tabbing mode will effect your video display as follows. The cursor will stay at the left column position on the screen (or the text window). The characters being printed will appear normally on the screen, and the destructive backspace will work.

- In the Absolute tabbing mode, the cursor (and displayed characters) will move around the screen unpredictably if the 40-character limit has been exceeded.

NOTE: If you have set the line length to 40 or fewer characters, there should be no problem. However, if you are using a line length of greater than 40 characters, your display will be effected.

To avoid either of these problems you can bypass the keyboard by writing a short program to initialize your printer and give the commands you wish.

Terminal Mode

Terminal mode lets you use your Apple to send and receive raw information. The information is not processed by the Apple, but sent directly to the screen, or both the screen and a parallel printer. The information cannot be saved in a file or manipulated by the Apple in any other way.

The parts of the system that remain active in Terminal mode are as follows:

- keyboard
- text screen
- serial input
- serial output

and, in Dual Mode

- parallel output

Terminal Mode has its own set of commands, called Modifiers, independent of the Command Sequences and Escape Codes. Terminal Mode Modifiers can only be given when Terminal Mode is active, and then only from the Apple keyboard.

Both the bell character (CTRL-G) and incoming line feeds are discarded in Terminal Mode. The bell is discarded because the time the Apple takes to sound the bell may cause a loss of characters. Line feeds are discarded because in Terminal Mode the Apple supplies its own.

Entering Terminal Mode

When you enter Terminal Mode, serial output must be active. There are two ways to enter Terminal Mode from this state:

CTRL-I H

activates Terminal Mode in half duplex.

CTRL-I F

activates Terminal Mode in full duplex.

If you are not sure what duplex setting your system requires, try half duplex first. If the half duplex is active when full duplex is required, characters will appear doubled on your screen. To change duplex, leave Terminal Mode by typing

CTRL-R

Then re-enter it with the command for the proper duplex setting. (See the section called "Leaving Terminal Mode" later in this chapter.)

Entering the Terminal Mode will clear the screen and position the cursor in the upper left corner.

Editing in Terminal Mode

A destructive backspace is the only editing character available in Terminal Mode. ("Destructive" means that the characters backspaced over are erased.) The backspace will be sent to your receiving device. To produce a backspace, press the left-pointing arrow key.

Terminal Mode Modifiers

There are six Terminal Mode Modifiers. All six must be entered from the Apple keyboard, not from an input device. Most of the Terminal Mode Modifiers are toggles. That is, the same Modifier is used to turn the feature on and off.

AUTO LINE FEED

If your receiving device requires a line feed with each carriage return you will want to use the automatic line feed toggle. The default condition is no line feed with a carriage return. The Terminal Mode Modifier to add an automatic line feed after each carriage return is

CTRL-A

This command does not affect your screen display, only the characters being output.

HIGH-ORDER BIT

Some devices expect the high-order bit, bit 7, to be set to 1, while other devices expect it to be cleared to 0. In Terminal Mode the default condition of the high-order bit is cleared to 0.

The Terminal Mode Modifier

CTRL-B

lets you toggle between the two conditions. This Modifier pertains to outgoing characters only.

CONVERT LOWER TO UPPER CASE

In Terminal Mode you have the option of converting all incoming lower case letters to upper case, or allowing mixed upper and lower case. This option does not work for outgoing characters. The default condition is all upper case.

The Terminal Mode Modifier for toggling this feature is

CTRL-C

Printing in Terminal Mode

If the printer is attached and turned on, type

CTRL-D

and whatever is being displayed on your screen will simultaneously be printed on your parallel printer.

If you wish to print on a parallel printer the information you are sending or receiving, you can use a special Terminal Mode feature called Dual Mode. In Dual Mode, everything that appears on your video screen is also printed on a parallel output device. Like most other Terminal Mode Modifiers, the Modifier to enable Dual Mode is a toggle.

One advantage of Dual Mode is that you can use the toggle to print on paper only the information you want to preserve. For example, if you are receiving quotes from the stock market you can activate Dual Mode to print an item that interests you, and then deactivate Dual Mode until something else of interest appears. Dual Mode uses the current parallel output parameters for printer control. However, the current serial output baud rate is used. The printer must be faster than the serial baud rate otherwise the printer will lose characters. The Dual Mode uses an external buffer located at location 5000 - 50FF HEX (20480 to 20735 DEC), in Apple main memory.

CAUTION: Any information resident in main memory between 5000 and 50 FF (HEX) will be altered by the printer buffer data. If information at this location must be preserved then it must be saved before the terminal mode is entered (and restored after you exit the terminal mode.)

This 256 byte buffer captures data that would be lost during the slow carriage return-line feed cycle of some printers (printer goes off

line during this period.) The printer character rate must be sufficiently faster than the incoming character data (baud rate dependent). This will enable it to make up for the time lost during carriage return-line feed operations (providing there are a sufficient number of characters between each carriage return-line feed operation.) If the auto line feed option in the Setup Menu cause printer performance to fall behind the incoming data, then it should be set to "NO". Internal printer forms control and printer auto line feed should be used in general. They do not require the CPS firmware to issue additional carriage return and line feeds. However, printer internal forms control may also cause the printer to lag behind the incoming character rate, so defeat the printer forms control to eliminate this problem.

NOTE: The printer must be able to retrieve data from the buffer at an average rate that will prevent a buffer overflow (lost data). The CRT will capture all the incoming data regardless of the printer's ability to keep up. The CRT character display may be used to compare the relative position of the printer and its ability to keep up with the incoming data. If the lines printed lag behind the lines displayed by more than one and the printer fails to catch up, then the printer will lose data.

The CPS parallel printer line length and paging parameters (in the Setup Menu) are ignored in the Dual Mode.

The destructive backspace works in Dual Mode. However, your printer must have the ability to recognize the backspace character. In Dual Mode you can repeat the backspace until the beginning of the line is reached. The printer cannot backspace further than that.

CAUTION: Before you activate Dual Mode, make sure your printer is plugged into the parallel port on the CPS Card. If your printer is not attached to the parallel port when Dual Mode is activated, your system will hang. You will have to power down to recover.

Sending Commands Literally

On some occasion you may want to send a particular arrangement of characters that happen to make up a Terminal Mode Mod-

ifier. For example, you might want to send a CTRL-A. The problem is, when you type the character, a command is issued instead of the character being sent.

The following command will cause the Terminal Mode Modifiers to be interpreted literally:

CTRL-SHIFT-P

When you use this Modifier, all characters will be interpreted literally until you indicate otherwise by typing this Modifier again. For example, if you wanted to send a CTRL-A and a CTRL-C to your receiving device and then go back to normal, you would type

**SHIFT-CTRL-P CTRL-A CTRL-C
SHIFT-CTRL-P**

The default setting for this feature is off.

Leaving Terminal Mode

A simple command will let you leave Terminal Mode. This command is the only Terminal Mode Modifier that is not a toggle. To leave Terminal Mode, type

CTRL-R

The screen will clear, the cursor will appear in the upper left corner and the bell will sound. Then type a

CTRL-X

and you will return to the serial output state.

Appendix A Using the CPS Card with Peripherals

This section provides specific information for interfacing the CPS Card to some common peripheral device types.

Parity

Parity is a method of verifying that the data received by a unit is error free, e.g. that all the bits in a transmitted data byte are present. It uses one bit (out of the 8 possible bits in a byte, in this case) to adjust the sum of the high-bits in a byte to either an odd number (Odd Parity) or an even number (Even Parity). A unit that sends data (CPS Card etc.) can add a parity bit (if needed) to cause all transmitted data to have an even (or odd) number of high bits. If an error occurs and a bit is lost during transmission (the most typical error) a receiving unit (printer etc.) will be able to detect the error. The CPS Card Setup Program provides the user with the option of selecting odd, even, or no-parity generation.

Using A Modem

A modem converts digital signal information into audio signals (tones) that can be sent, via the phone lines, from one data processing unit to another at some remote location. Some form of handshaking (e.g. Are you ready to accept data? Yes, send the data) must accompany the information transmission.

Your modem will be one of two types, an originate-only or an originate and answer type. The originate-only modem uses a single carrier frequency for data transmission. The originate/answer modem receives (answers) data at one carrier frequency and transmits (originates) data on another frequency.

Half Duplex

In the half-duplex mode only one party can send data at a time. In order to operate you need handshaking signals (to switch senders etc.)

Full Duplex

The full duplex mode allows both parties to send data at the same time (handshaking is still required but data transfer is faster.) The two channel availability of the full duplex mode enables the receiver to "echo" the re-

ceived data back to the sender (via the unused line). This allows the sender to check the quality of the data that is received at the other end.

Carriers

If you dial-up a remote computer system's modem you will hear the carrier frequency (audio tone) on your phone receiver. This tone indicates that the remote modem is ready to send or receive data (if you get a busy signal, someone else is using the modem.)

Once it receives the carrier from your modem (when you place the phone handset into the modem) it knows that you are ready to send or receive data. One modem must send the originate tone and the other must send the answer tone. Once each modem has received a complementary carrier from the other, then communications can proceed.

NOTE: Interruption of either modem's carrier will cause the link to be broken (data communication will stop and the dial-up process must be re-started.)

The presence of a carrier causes one handshaking signal to be sent from the modem to the CPS Card (Pin 8 of the Serial I/O cable). This signal, "Data Carrier Detected" (DCD), indicates that the carrier from the remote modem has been detected (Pin 8 of the I/O cable goes high, +12 Vdc).

NOTE: If the remote system hangs or the carrier is disrupted this line will go low and your system will terminate I/O operations. You can disable the DCE signal by tying Pin-8 of the I/O cable to +12 Vdc.

The MCI RS-232 DB25 Pin Reconfiguration Adapter PN 01-00243-01 enables the user to perform this task simply by setting a slide switch.

The "Request To Send" (RTS)/"Clear To Send" (CTS) signal pair provide another part of the handshaking process. These handshaking signals are assigned to Pin-4 (RTS) and Pin-5 (CTS) of the I/O cable.

NOTE: Check your modem manual to determine if there is a delay generated during the time RTS goes high and before CTS returns high. If a delay is generated in the modem, disconnect it (if possible).

If the delay cannot be disconnected within the modem then tie the CPS RTS line to the CTS line (or set the proper slide switch on the MCI 01-00243-01 mentioned above).

This will eliminate an unnecessary I/O delay and improve your throughput.

When communicating with a remote computer system (e.g. another Apple) you can use the Terminal Mode to emulate a terminal. This mode is convenient for communicating with timesharing networks (Source™, MicroNet™ etc.) The Terminal Mode will disconnect you from the Apple operating system (BASIC, Monitor etc.). This will allow you to display the incoming and outgoing data without initiating a "SYNTAX ERROR". The first time you talk to a remote system you have to experiment with duplex, linefeeds, and your framing to match the timesharing system.

NOTE: If you have a keyboard send/receive (KSR) terminal and want to receive input as well as sending output, do not use the Terminal Mode. Enter (instead) a "PR#n" and a "IN#n" (for a serial terminal). This will cause the KSR terminal to control the Apple screen (it can still be enabled by the CPS Card) and the Apple keyboard. This will enable you to enter lower case and special control characters, and display your output at full width.

To disconnect the terminal use the "PR#0" and "IN#0" commands.

The following defaults set the appropriate configuration for talking to most remote computer systems.

Suggested Defaults:

8 Data Bits (high-bit cleared)
No Parity
1 Stop Bit
300 Baud

Using a Serial Printer

One of the problems you may encounter when

trying to send data to a serial printer is that you must switch the transmit and receive lines between the CPS Card and the printer. This I/O signal line switch can be performed by wiring two DB25 connectors together with Pin 2 of each connector tied to Pin 3 of the other. Pins 7 and 1 are connected straight across and the appropriate handshaking lines must be wired. Refer to the RS-232 Tutorial, in this Appendix, for additional information.

NOTE: If you have a MCI PN 01-00243-01 Reconfiguration Adapter set the appropriate slide switches to accomplish this task.

The CPS Card generates a "Request To Send" (Pin-4) signal and expects a "Clear To Send" (Pin-5) signal in return. If your printer does not provide this handshake, then you must tie these two lines together. You will also have to provide a "Data Terminal Ready" signal response to the CPS Card "Data Set Ready" signal. Or tie Pins 6 and 20 together.

NOTE: If you are using a slow or a buffered printer you may need one or both of the signal pairs described above to establish a working interface (refer to the printer maintenance manual for additional information).

If your printer supports an alternate character set (e.g. graphics) you will have to set (or clear) the high-bit when sending normal text. If you wish to send the alternate characters either send the "S" or "C" escape codes (from the keyboard) before beginning the transmission, or insert the escape code within your text (or program) to switch the state of the high-bit.

CAUTION: Don't forget to switch it back when you are finished!

Using a Parallel Printer

If your parallel printer is an Epson MX-80 refer to Chapter 2 and the wiring diagrams at the end of this Appendix. If your printer is not an Epson, you will need the information in this section to set up the interface to the CPS Card. If your parallel printer uses a Centronics™-type interface you can plug it in and establish a working interface without modifying the I/O cable. Other interface configurations will require the fabrication of a special I/O cable

(refer to Appendix B, "Parallel Interfacing" for additional information.)

NOTE: You may have to change the position of the Polarity Jumpers (refer to Appendix B "Advanced Programmers Information" for additional information) for proper printer operation.

To operate properly the printer must receive a STROBE signal during data transmission. Upon receipt of the data (and STROBE) the printer will send an ACKNOWLEDGE to the CPS Card.

NOTE: If you have a BUSY line and no ACKNOWLEDGE, you may be able to substitute BUSY by inverting the polarity of the BUSY signal.

The parallel port can be used to operate other peripheral devices (e.g. plotter or test instrument). Cables for such an application will have to be custom-made.

Serial Protocols (A Brief RS-232 Tutorial)

Introduction

The Electronic Industries Association (EIA) is an organization that establishes electronic equipment standards. The RS-232 standard establishes communication (handshaking and data transfer) interface requirements for the serial (as opposed to parallel) transfer of data. The standard is directed at the transfer of serial data between data terminal equipment (DTE), and data communication equipment (DCE).

Handshaking

The handshaking protocol provides conventions for determining who will receive and who will transmit data. It also establishes the means for indicating the end of a data transmission and the request to initiate a data transmission. Refer to Figure A-1 for data signal levels and handshaking signal descriptions. Many peripheral devices operate at a slower data input rate than that of the sender (a printer may print slower than the computer's ability to supply the information to be printed.) The handshaking signal lines prevent a data overflow from occurring. Devices must also have the ability to tell the computer when they are off-line (cannot send and/or receive data.).

An RS-232 interface contains two handshaking signal pairs and the Data Carrier Detected handshake line (RC, ST and * in Figure A-1).

RC Signal Pair

The sending device (CPS Card) causes the Request To Send signal (RTS) to go high when it wants to send data. The peripheral device answers with a Clear To Send (CTS), if it is ready to accept data.

NOTE: At one time modems were designed with an internal delay to handle RTS to CTS signal transit time from one modem (via phone line) to another during the half-duplex mode. The half duplex mode of operation is seldom used today; if your modem has this delay it should be eliminated to improve communication speed.

If the modem cannot be internally modified to eliminate the delay, then tie the RTS line to the CTS line by modifying your I/O cable or setting the proper slide switch on your MCI Reconfiguration Adapter.

ST Signal Pair

The Data Terminal Ready (DTR) and Data Set Ready (DSR) signal pair operate in a way that is similar to the RC signal pair. The major difference is that the DTR/DSR pair are activated by software (the CTS/RTS are tied to the hardware).

NOTE: The CPS Card software looks for the DSR and DCD signals, if the peripheral device does not provide them, then the I/O cable must be modified (DSR and DCD tied high).

Data Carrier Detected

The Data Carrier Detected (DCD) signal is a single line that is used by modems. Its presence verifies that two modems are connected properly (via phone line). When the modems are communicating, each will send (and detect) a carrier tone; the transmission will be discontinued if a modem fails to detect the other's carrier.

Interface Signal Levels (per EIA):
 MARK = OFF = ONE = -3 to -25 v
 SPACE = ON = ZERO = +3 to +25 v

Framing:
 Start bit--always space
 Data bits 5, 6, 7, or 8--may be mark or space
 Stop bits 1, 1.5, or 2--always mark--idle state

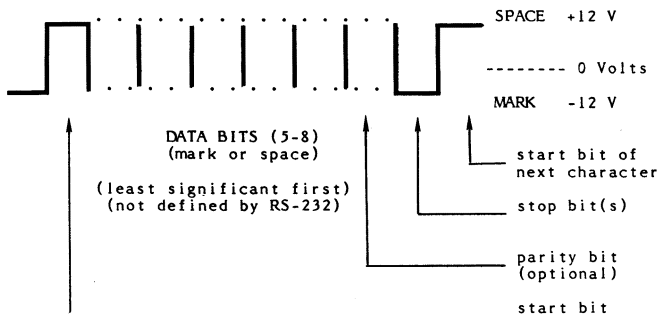

Signal descriptions: (at the MultiFunction Card--TO DCE)

DB-25 Pin #	EIA Code	Input/Output	EIA Signal Name	Pairing-TO	See text
1	AA	I/O	Protective ground	DTE/DCE	
2	BA	OUT	Transmitted data	DCE	DA
3	BB	IN	Received data	DTE	DA
4	CA	OUT	Request to send	DCE	RC
5	CB	IN	Clear to send	DTE	RC
6	CC	IN	Data set ready	DTE	ST
7	AB	I/O	Signal ground	DTE/DCE	
8	CF	IN	Data carrier detected	DTE/DCE	*
20	CD	OUT	Data terminal ready	DCE	ST

RS-232 Summary

0616814

Figure A-1 RS-232 Serial Protocol Signal Descriptions

Parallel Data Bus Tutorial

Parallel data transfer from the CPS Card to a peripheral device (and vice versa) is accomplished via a 10-line I/O bus. Eight lines carry a byte of parallel data and two lines are used for handshaking. The handshaking lines are called "STROBE" and "ACKNOWLEDGE" (or "BUSY"). Refer to the Parallel Signal Timing diagram, Figure A-2, for additional information.

The Strobe Line

The Strobe Line (from the CPS Card) tells the peripheral device when data is ready to be transferred to the device. The device (printer etc.) monitors the Strobe line; if it detects a transition in the state of the line (from high to low, or vice versa) it is informed that the CPS Card has data to send. In order for this handshake to function you must determine which

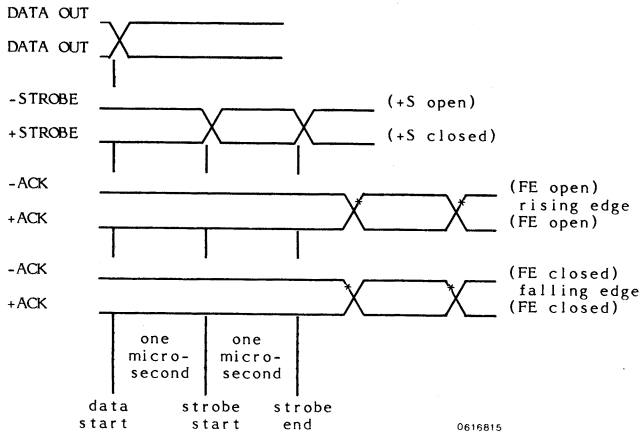

Figure A-2 Parallel Signal Timing

direction the transition must follow (low-to-high or high-to-low). The Strobe transition direction will determine the positioning of the Strobe jumper on the CPS Card (+S = positive going transition, removing the jumper = a negative going transition). Refer to Figure 2-2 for additional information.

NOTE: The strobe line from the CPS Card uses an open collector driver. Your peripheral device must supply the current for switching the logical state of the strobe line.

Once the strobe line changes state, the data byte on the data lines must remain stable long enough for the peripheral device to transfer the byte to its internal buffer or latch. The CPS Card provides a 1-microsecond period for this transfer to occur.

NOTE: All the timing requirements for an Apple to Centronics type interface are supplied by the CPS Card. If your peripheral device cannot read the data during this 1-microsecond period, then you will have to provide some intermediate circuits to latch the data in the time allocated.

ACKNOWLEDGE/BUSY Line

The ACKNOWLEDGE (or BUSY) line provides the peripheral device with a handshake line that informs the CPS Card when it is ready (or busy) to accept data.

If your printer has a BUSY line instead of the ACKNOWLEDGE line you will have to set the FE jumper on the CPS card for falling edge detection by inserting the jumper in a vertical position. Removing the jumper will detect a rising-edge; refer to figure A-2 for additional information. No data will be transferred to the remote device while it is active.

Parallel Data Lines

The Apple ASCII character set requires six of the eight data lines (transmission of uppercase characters). The remaining two data lines are used for screen formatting information (inverse screen image, normal image, and flashing screen). These two lines are not required when transferring data to a peripheral device if an Apple keyboard was used to enter the data.

Application programs or hardware modifications are available that allow the entry of lower case characters (requires all 8 I/O data lines). The CPS Card provides this capability.

Appendix B Advanced Programmer's Information

This section is provided for advanced programmers who wish to use the MultiFunction Card from machine language programs and/or for special applications requiring RAM drivers. If you are a beginning programmer you may find this section confusing and full of unfamiliar terms. BASIC programmers can use the Card without reading this section.

General Organization

The MultiFunction Card uses the I/O Select addressing area of the Apple's peripheral slot space; the \$C800 space is not used. The I/O Select area uses the \$Cnxx addresses, (where n is the slot number). No device select addresses (\$C08x + \$n0) are used, so the Card cannot be used in slot 0. The 2K of ROM is mapped as eight banks, each bank occupying the same area, from \$Cn00 to \$CnEF. The area from \$CnF0 to \$CnF7 is occupied by 32 eight-byte banks of non-volatile RAM, and the top eight addresses are used for device control and registers (refer to the Hardware Location Summary, Figure B-1). The high bit of \$CnF9 shows the state of the spare input TTL input line. It could be used, for example, as a shift-key detector. Pinout is (pin 1 is at upper left, closest to the keyboard):

- J3-1 - Input
- J3-2 - Ground

Other connector pinouts are (refer to Figure B-1 for additional information):

Serial I/O:

- J1-1 - Ground
- J1-2 - External Transfer Clock I/O
- J2-1 - Ground
- J2-2 - External Receiver Clock I/O
- J4-1 - Chassis Ground
- J4-2 - TXD
- J4-3 - RXD
- J4-4 - RTS
- J4-5 - CTS
- J4-6 - DSR
- J4-7 - Signal Ground
- J4-8 - DCD
- J4-9 through J4-19 no connection
- J4-20 - DTR
- J4-21 through J4-24 no connection
- J4-25 - +12Vdc
- J4-26 - no connection

Parallel I/O:

- J5-1 - Signal Ground
- J5-2 - ACKNOWLEDGE
- J5-3 through J5-7 no connection
- J5-8 - STROBE (open collector)
- J5-9 no connection
- J5-10 - DATA0
- J5-11 - DATA1
- J5-12 - DATA2
- J5-13 - DATA3
- J5-14 - DATA4
- J5-15 - DATA5
- J5-16 - DATA6
- J5-17 - DATA7
- J5-18 and J5-19 no connection
- J5-20 - Signal Ground

Parallel Polarity Jumpers:

- +S - POSITIVE STROBE (if connected)
- FE - FALLING EDGE ACKNOWLEDGE (if connected)

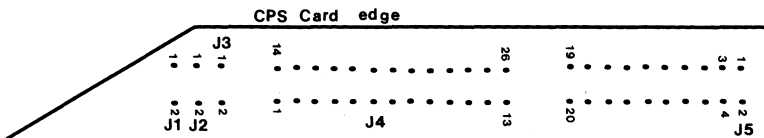

Figure B-1 Connector Layouts

Serial Handshaking Protocol

The handshaking protocol for serial operation is as follows:

- Request To Send is raised before data is output.
- Clear To Send must be high before outgoing data will be transmitted.
- Data Carrier Detected must be high before either transmitting or receiving data.
- Data Terminal Ready is held high whenever the CPS Card is active.
- Data Set Ready must be high before data can be received (or transmitted) when the CPS firmware is in use.

Other Information

Your CPS Card allows the use of the entire 128-character ASCII set, and the 'Clear High Bit' parameter allows you to choose which (high or low) set will be output. If you wish to use all 256 characters (for graphic output, for example), you must include the escape code in your text/output stream to switch the state of the high bit as required.

If you are using the 2K ROM (as supplied) then bit 3 of \$CnF8 is used to select the upper half of the RAM banks. The supplied ROM uses RAM banks 0 through 7; banks 8 to 31 are available to users. Individual entry points to subroutines in the ROM are not provided, so if you wish to alter some of the features you must duplicate the functions you require and add your changes.

You may wish to drive the individual devices with direct use of the \$CnF8 to \$FF register area. Observe these cautions:

- Be EXTREMELY careful if you use the 'phantom slot' mechanism directly. You could mask out your disk controller, and be unable to reboot! If you get into this difficulty, see Chapter 4, 'The Phantom Slot Feature' and the section at the end of this Appendix.
- Watch your bank-switching housekeeping very carefully: If you have problems such as an apparent inability to change or read a RAM location, suspect your use of the bank select mechanism. If you are peeking at run-time bytes for some purpose, be very sure to save the current bank-select byte and to restore it before you exit.

- The Serial Port is a very complex chip, with many options. If you are using it directly, we strongly suggest that you obtain a manufacturer's data sheet and study it well. Study the SCR bit operation and the mapping of the Command and Status registers. If you are using indexed addressing, remember the 6502's false read problem.
- There are certain timing constraints on the clock chip that must be understood before writing or reading the time. Obtain a manufacturer's data sheet and observe all timing delays specified.

Using the CPS Card From the Monitor

To activate the CPS Card from the Apple monitor (prompt = *) use the normal sequence:

```
n(CTRL-P) for output, where n = slot
                                number
n(CTRL-K) for input
```

If using DOS, the command line should look like this:

```
2(CTRL-P) 3EAG slot 2 output
5(CTRL-K) 3EAG slot 5 input, etc.
```

This conforms to standard Apple peripheral card conventions. Phantom slots may be used exactly as from BASIC.

Using the Card From Machine Language Programs

To select the MultiFunction Card from a machine language program you should follow normal Apple peripheral card conventions.

To initialize the card, use the following procedure:

```
JSR $Cn00 ;does initializing
LDA #CHAR ;load CHAR into accumulator
JSR $Cn05 ;output CHAR
JSR $Cn03 ;does input
           ;returns CHAR in accumulator
STA BUFFER ;etc.
```

The above fragment does not affect the input or output hooks, which would be done by a "PR#n" or "IN#n" command. The procedure to stimulate a PR#n command is illustrated in the following program fragment:

```
CSWL EQU $36 ;low byte of output
           vector
```



```

CSWH EQU $37 ;hi byte
SLOT EQU $02 ;select according to
; device
;
INIT LDA #SLOT ;set up hi byte of
+$C0 ;output vector
STA CSWH ;you may wish to save
; old vector
LDA #$00 ;now do low byte
STA CSWL ;output vector now =
;$Cn00
RTS ;now send a char to
; initialize

```

If you wish to do an 'IN#n' follow the same procedure using KSW (\$38). You can accomplish the same operations by using Apple Monitor subroutines; the procedure is essentially the same.

Remember, the above procedure will only select the current device; if you wish to change the default device, use a procedure like the one below.

NOTE: You must direct device-selecting command sequences to the actual slot containing the CPS Card; phantom slots cannot be used for changing from default devices.

```

SLOT EQU 2 ;insert your slot here
INIT EQU $C000 ;initializing entry
+$SLOT*256 ;point
SEND EQU INIT+5 ;character output
; routine
;
CHDEV JSR INIT ;do PR#n—NO
; phantom device
; change
; for indexing
CLOOP LDA #0 ;get first character
TABLE-1,Y ;send to Card
JSR SEND ;bump index
INY ;allows any length
CPY ;table
#TBLEND-
TABLE ;else continue
BNE CLOOP
RTS ;end of device change
; routine
TABLE DFB $17 ;command character
DFB 'I', 'O' ;select serial port
; for I/O
TABLE DFB $8D ;command terminator
TBLEND EQU * ;mark end of table

```

Remember when using these procedures:

If you do both a 'PR#n' and an 'IN#n' and try to get a character from the input device, you will output whatever is in the accumulator, because the firmware assumes (per Apple convention) that the request is for output.

Doing your I/O without DOS will improve your throughput. You can still send DOS commands through \$FDED, as the output vector still points to DOS. The JSR \$Cn05 writes characters out directly to the device and cannot activate any DOS commands. The JSR \$Cn03 command gets a character directly from the CPS Card.

The Phantom Slot Feature

Your CPS Card supports the ability to mask out other peripheral cards and trap their calls. This allows the multiple devices on the CPS Card to be mapped to slots other than that in which the CPS Card is actually located.

This is done by using the 'USER1' line on the Apple bus. We know of no other peripherals which use this line, but if you acquire one you will need to understand how that line is used.

The DIP carrier at H-12 gives the CPS Card access to the USER1 line (AFTER the jumper on the motherboard), which inhibits ALL peripheral cards which use I/O SELECT to activate their chip-enable lines.

Briefly, the USER1 line, when low, pulls both DEVICE SELECT and I/O SELECT high. The CPS Card uses address decoding but NOT I/O SELECT as chip enables. Therefore, when the USER1 line is low the CPS Card will NOT be disabled, but all peripheral cards which use either DEVICE SELECT or I/O SELECT will be disabled. This is independent of the state of the USER1 JUMPER on the motherboard. The register at \$CnF7 is a mask which determines whether or not the selected slot will be disabled or not.

The only obvious way that there can ever be contention is if another card is present which uses address decoding for its chip enables rather than the standard use of DEVICE SELECT or I/O SELECT. Under that circumstance (assuming that the CPS Card byte at \$CnF7 has the bit for that slot set true) it is possible for both cards to compete for the bus.

You must clear the appropriate bit of the byte at \$CnF7 to prevent trapping of the other slot's

calls, under these (admittedly unlikely) circumstances. If you ever have difficulty reaching a peripheral card, the first thing to try is the monitor command 'CnF7:0' (from BASIC: 'POKE - 16137 + n*256, 0, where n must be the ACTUAL slot), and then press the RESET key. This will transfer the default value to the runtime location and disable all phantom slots. If this does not help, then your problem probably does not originate on the CPS Card.

CPS Hardware Location Summary

Figure B-2 (Hardware Location Summary) provides the machine language programmer with a map of the CPS Card devices (including some that are not supported by the firmware.) Data may be entered into these memory locations to change the operation of the CPS Card and/or the peripheral device connected to the card.

NOTE: Manufacturer's data sheets for the OKI Clock/Calendar (Part No. MSM 5832) and the Signetics Serial PCI (Part No. INS 2651) should be acquired, if you are using these devices in a way that is not supported by MCI firmware.

Hardware Location Summary Organization

The following paragraphs provide information on the information located in Figure B-2.

HOW TO READ THE MEMORY MAP GRID

Organization of Memory Map Grid

TOP

The words "DATA BUS" appear across the top of the diagram and below "DATA BUS", "D7" through "D0" labels the 8 data bits on the Apple's bi-directional data bus. Each data bit represents a function within the address locations.

LEFTSIDE

Along the left side of the memory map, memory locations from CN00 to CNFF (where N represents the slot number) indicate the I/O Select addressing area of the Apple's peripheral slot space; the C800 space is not used. These addresses are listed alongside the memory map; they are the register locations for the CPS card. These locations usually can be read or written to.

RIGHTSIDE

The right side of the memory map designates the specific function of each register or address. The device functions are for serial, parallel, clock, RAM, and ROM use. Alongside of each register is R for read and W for write.

LOWER LEFT CORNER

This corner of the diagram contains a key for identifying the status of each location. This key has three features:

1. The diagonal slash divides the block into READ and WRITE segments, the upper READ, the lower WRITE.
2. The two parallel horizontal lines in the upper right corner mean the data is not accessible.
3. Inside the rectangle block is another block divided by the READ and WRITE lines. The upper section of the block contains the value of the initialized state either when the Reset key is hit or immediately after power is turned on. The lower section of the block contains the value that occurs after the initialized state, but this value can be changed by rewriting it. If there is a blank in either section, and the WRITE or READ function is accessible, either 1 or 0 could appear in each data bit. This is the case for location CNF0. Another instance, in location CNFF all 8 data bits are inaccessible to both READ and WRITE functions. Others are available for both READ and WRITE.

Legend of Abbreviations

These following abbreviations start at location CNFE in the upper left corner of the memory map and continue downward to location CNF7. You will need this explanation of abbreviations to identify the specific functions of each data bit in the map. For more details, the clock and serial data sheets should be referred to.

CONTROL REGISTER BIT

SCR	SERIAL CONTACT
+CH	CLOCK HOLD
+CW	CLOCK WRITE
+CR	CLOCK READ
+CA#	CLOCK ADDRESS (0-4)
+P0#	PARALLEL DATA OUT (0-7)
+I/0#	I/O SELECT MAPPER (for phantom slots 1-7)
+OM#	OPERATING MODE (I/0)

RTS	REQUEST TO SEND
+RE	RESET ERROR
+BRK/DLE	FORCE BREAK/SYNC
+TXEN	TRANSMITTER ENABLE
DSR	DATA SET READY
DCD	DATA CARRIER DETECT
+FE/SYN	FRAMING/SYN CHARACTER DETECT
+OVRN	OVERRUN ERROR
PE/DLE	PARITY/DELETE CHARACTERS
TXEMT	TRANSMIT SHIFT REGISTER IS EMPTY
+RXRDY	RECEIVE HOLDING REGISTER STATUS FLAG
+TXRDY	TRANSMIT HOLDING REGISTER STATUS FLAG
SY (0-7)	SYNC. CHARACTER (SYNC. MODE)
+SB1	SYNC. NC. OR SYN CHARACTERS
+SB0	SYNC. TRANSPARENCY CONTROL
+PT	PARITY TYPE
+PE	PARITY CONTROL
+CL(1,)	CHARACTER LENGTH
+BRF(1,0)	MODE AND BAUD RATE FACTOR
TXC	TRANSMITTER CLOCK
RXC(4,2,1,0)	RECEIVER CLOCK
+BR(0-4)	BAUD RATE SELECTION
+SI(0-7)	SERIAL INPUT CHARACTER
+SO(0-7)	SERIAL OUTPUT CHARACTER
SPARE	SPARE INPUT
+OBE	PARALLEL STATUS BIT (OUTPUT BUFFER EMPTY)
+CD(4,2,1,0)	CLOCK DATA I/O
+RAS(4,2,L, 0,8)	RAM BANK SELECT
+ROS(2,1,0)	ROM BANK SELECT

How the Address Assignments Work

INTRODUCTION

This section covers what each address assignment represents. The CPS MultiFunction Card uses the Apple's peripheral slot space (\$CN00-\$CNFF where N= slot no.); the \$C800 space is not used. The convention dollar sign (\$) indicates a hexadecimal notation. The I/O Select area uses the \$ CNxx addresses. No device select addresses \$C08X + \$n0) are used so the card cannot be used in slot 0 which is why I/O of address location \$CNF7 cannot

be READ or WRITTEN to. The locations will not be discussed in exact numerical order; however, this presentation follows a logical order showing the interconnections between the locations' functions.

ROM LOCATIONS (\$CN00-\$CNFF)

The 2K memory locations of the CPS ROM are mapped as eight banks, each bank occupying 240 bytes from \$CN00 to \$CNEF. A byte equals 8 data bits (D0-D7).

RAM LOCATIONS (\$CNF0-\$CNF7)

The memory area from \$CNF0 to \$CNF7 is occupied by 32 eight-byte banks of battery backed non-volatile RAM memory. The supplied ROM uses RAM banks 0 through 7; banks 8 to 31 are available to users. The \$CNF7 function will be explained later when phantom slot use is discussed.

RAM/ROM BANK SELECT (CNF8)

The first three data bits (D0-D2) of \$CNF8 are used to select the 8 ROM banks (0-7). When the next bit, D3, has a 1 written to it, it selects the upper range of RAM banks (26-31). When D3 has a 0 written to it, the lower range of RAM banks (0-15) are selected. The rest of the data bits (D4-D7) select the particular bank within either the upper or lower range of banks.

CLOCK DATA I/O AND PARALLEL/SPARE STATUS (\$CNF9)

The clock data can be read or written into using D0 to D3 of location \$CNF9. This is a four-bit data bus to the clock. Data bits D4 and D5 are not used. Data bit 6 is where you can read the parallel status bit when you want to check whether the acknowledge signal is accepted and the device is ready to receive its next parallel data. The high bit, D7, shows the state of the spare TTL input.

PARALLEL DATA OUT (\$CNFD)

Location \$CNFD contains the parallel data output. This bits (D0-D7) can only be written to.

CLOCK ADDRESS & CONTROL AND SERIAL CONTROL (CNFE)

D0 to D3 of \$CNFE are clock addresses that you can write to. The next three bits (D4-D6) are the clock control functions. CR reads the clock; CW writes to the clock; CH holds the time. "Holding the clock" is important because the clock has a complex algorithm for producing the time, and the clock should remain constant on "hold" when you read the time.

The high data bit, D7, is the serial control bit which creates options in locations \$CNFB and \$CNFA for the different levels within those registers.

**SERIAL REGISTERS (\$CNFA \$CNFB)
COMMAND REGISTER AND STATUS REGISTER AND SYN1/SYN2/DLE (\$CNFB)**
When serial control (SCR) = 1, the upper serial functions can be read or written to. When SCR = 0, the lower serial functions can be read or written to. This is a case when you need to have the serial data sheet available because of the complexity of these registers. It is important to realize that the serial control bit acts like a switch which shifts levels within the location.

MODE REGISTER 1 AND MODE REGISTER 2 AND SERIAL DATA I/O REGISTER (\$CNFA)
\$CNFA uses the serial control bit just like \$CNFB does, except MODE REG. 1 and 2 share the same location. You must always use them together; that is, you must always write to them both or read from them both. You can never just look at one by itself. Inside the serial chip memory this information is routed to the right register. The data for MODE REG. 1 is handled first, and the data for MODE REG. 2 handled microprocessor. When SCR = 0, the DATA INPUT/OUTPUT REG. for serial communication can be read or written to.

I/O SELECT MAPPER (\$CNFC)

Location \$CNFC controls the peripheral slot use of the Apple Computer I/O SELECT MAPPER refers to designating which slot or slots the CPS Card will reside in. Each data bit enables a particular slot from 1 to 7. The CPS Card can reside in three separate slots at once. This feature is called phantom slotting because the card is physically in one slot, but can operate from another slot even though it is not in it. The phantom slot procedure works in the following manner. Each data bit, except D0 (slot zero is not used by the CPS Card), designates which slot the CPS can be located in. Even if another card is physically in the designated slot, the CPS Card will step in front of the other card and become the operating card.

I/O SELECT DEFAULT (\$CNF7)

Location \$CNF7 is bank 0 or RAM. It is used to store the slot location put into the I/O MAPPER, so that the phantom slot arrangement

will remain in memory. If the slot location was not saved in memory, you would have to supply the slot location each time you powered up the computer. You specify the slot you want for the I/O SELECT DEFAULT. CPS Card peripherals can use "phantom slots" regardless of which slot the CPS Card has been plugged into.

CPS CARD RAM BANK DESCRIPTION

The CPS card firmware uses 8 RAM Banks. Bank 0 is the control bank, Bank 1 is the default serial out bank, Bank 2 is the default parallel out bank, Bank 3 is the default serial in bank, Bank 4 is the runtime serial out bank, Bank 5 is the runtime parallel out bank, Bank 6 is the runtime serial in bank, and Bank 7 is used for storing page 0 locations. During initialization the 2651 USART is initialized and the default banks are copied to their runtime counterparts; e.g. Bank 1 is copied to Bank 4. To access a bank in machine language, use the following type code:

```

BNKSEL EQU $C1F8
BANK EQU $40 ;The serial bank (Bank #*16)

CTRLBANK EQU $0 ;The control bank

LDA #BANK
STA BNKSEL ;Switch to this bank

: ;Action desired

LDA #CTRLBANK
STA BNKSEL ;Restore control bank when done

```

The example given used absolute addressing with the card in SLOT 1 but it would have worked fine with indirect addressing.

Next will be a short description of the different banks.

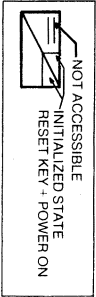
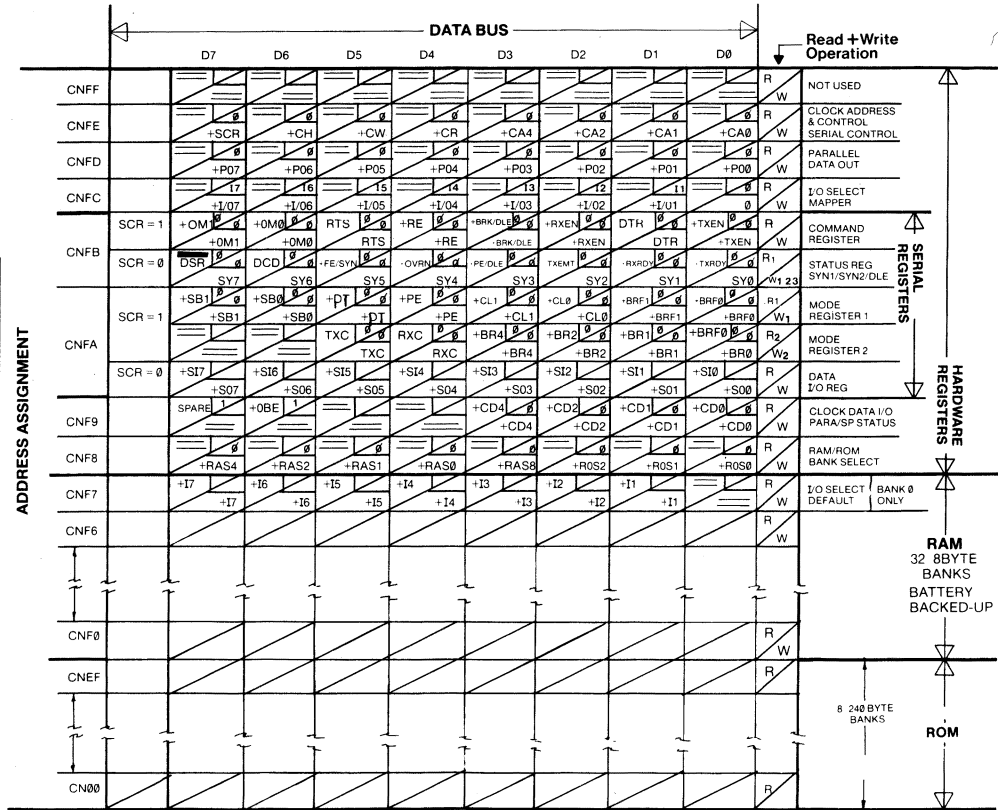

Figure B-2 Hardware Location Summary

CONTROL BANK (Bank 0)

CNF0: \$CN, where N = CPS Card physical slot location.

CNF1: Clock counter, initialized to zero.

CNF2: Serial mode register 2.

X	X	1	1	Baud rate
7	6	5	4	3 2 1 0

baud rate:

0- 50	4- 150	8-1800	C- 4800
1- 75	5- 300	9-2000	D- 7200
2-110	6- 600	A-2400	E- 9600
3-134.5	7-1200	B-3600	F-19200

CNF3: Serial mode register 1

S	B	P	A	C	L	1	0
7	6	5	4	3	2	1	0

SB-# of stop bits PA = parity CL = Character length

01 = 1 stop bit	01 = odd	00 = 5 bits
19 = 1 1/2 stop bits	10 = even	01 = 6 bits
11 = 2 stop bits	X0 = no parity	10 = 7 bits
		11 = 8 bits

CNF4: Device select & clock byte

E	CP	S	CF	DO	CO	DI	CI
7	6	5	4	3	2	1	0

E-escape processing in progress flag, initialized to zero.

CP-output permitted when clock is active device, initialized to zero=no

S-stop escape processing, initialized to zero#don't stop

CF-clock format, 0 = type 1 1 = type 2

DO-default output device associated to CPS physical card slot
0 = serial 1 = parallel

CO-current output device, initialized to "DO"

DI-default input device associated to CPS physical card slot
0 = serial 1 = clock

CI-current input device, initialized to "DI"

The next three bytes are associated with phantom slot selection. BITS 1-7 of each byte refer to the particular slot 1-7. If a bit is set in CNF7 then that slot has been phantom selected. If selected then the corresponding bit in CNF6 will indicate the device, serial or parallel/clock. If the bit is set in CNF6 then the corresponding bit in CNF5 will distinguish between parallel or clock.

CNF5: phantom device differentiation
1 = parallel 0 = clock

PC ₇	PC ₆	PC ₅	PC ₄	PC ₃	PC ₂	PC ₁	X	0 0
7	6	5	4	3	2	1	0	

CNF6: phantom device
0 = serial 1 = parallel/clock

PD ₇	PD ₆	PD ₅	PD ₄	PD ₃	PD ₂	PD ₁	X ₀	0 0
7	6	5	4	3	2	1	0	

CNF7: phantom slot selection,
0 = no, 1 = yes

PS ₇	PS ₆	PS ₅	PS ₄	PS ₃	PS ₂	PS ₁	X	0 0
7	6	5	4	3	2	1	0	

SERIAL OUT BANK

default = Bank 1 runtime = Bank 4

CNF0: Assorted Flags

E	X	A	D	S	LF	LC	HI
7	6	5	4	3	2	1	0

Runtime
E-output escape processing in progress.
A-absolute tabbing mode
D-suppress video display

0	0	0	0	0	LF	LC	HI
7	6	5	4	3	2	1	0

Default
S-special inverse video display
LF-send LF after CR
LC-do lower to upper case conversion
HI-clear high order bit

CNF1: output escape char (\$81 = CTRL-A, \$89 = CTRL I)

CNF2: line length (1 to 255)

CNF3: paging (0 = no paging 1 to \$FF = lines/page)

CNF4: lines remaining on page (initially set to CNF3)

CNF5: lines to skip for paging

CNF6: delay after carriage return 0 to 255 in 10 millisecond increments.

CNF7: current column (initially set to zero)

PARALLEL OUT BANK

DEFAULT = Bank 2 runtime = Bank 5

All the bytes for parallel out are the same as with serial out; the difference being the bank numbers.

SERIAL IN BANK

default = Bank 3 runtime = Bank 6

CNFO: assorted flags

X	X	X	X	X	X	LC	EC
7	6	5	4	3	2	1	0

LC-convert lower to upper case
EC-eccho characters back

CNF1: escape character = CTRL N (not used)

CNF2: \$55 validity byte

CNF3: \$AA validity byte

CNF4: \$01 validity byte

CNF5: \$55 validity byte

CNF6: \$AA validity byte

CNF7: \$01 validity byte

CPS Cables

The following table lists the I/O cables presently available from Mountain Computer.

Table B-1 MCI Peripheral I/O Cable List

MCI PART #	PERIPHERAL	I/O CABLE TYPE
		P = PARALLEL S = SERIAL
01-00156-01	Modem	S CPS-J4 to DB25 Male
01-00156-02		S CPS-J4 to DB25 Female
01-00213-01		S DB25 Male to DB25 Male
01-00263-01	IDS Printer	P CPS-J5 to DB25 Female
01-00264-01	Epson, Centronics and C ITOH Printers	P CPS-J5 to Centronics type connector
01-00265-01	IDS Printer	S CPS-J4 to DB25 Female
01-00266-01	Hazeltine Type Terminals	S CPS-J4 to DB25 Male
01-00299-01	Diablo Printer	S CPS-J4 to DB25 Female

Figures B-3 through B-9 provide pinout information for these cables.

To CPS Connector J4 Pin	To Modem DB25 Connector Pin
1	1
2	2
3	3
4	4
5	5
6	6
7	7
8	8
9	9
10	10
11	11
12	12
13	13
14	14
15	15
16	16
17	17
18	18
19	19
20	20
21	21
22	22
23	23
24	24
25	25
26 No Connection	

(Female) (Male)

Figure B-3 01-00156-01 Cable

To CPS Connector J4	To Modem DB25 Connector
Pin	Pin
1	1
2	2
3	3
4	4
5	5
6	6
7	7
8	8
9	9
10	10
11	11
12	12
13	13
14	14
15	15
16	16
17	17
18	18
19	19
20	20
21	21
22	22
23	23
24	24
25	25
26	No Connection

(Female) (Female)

Figure B-4 01-00156-02 Cable

DB25 Con. A	DB25 Con. B
Pin	Pin
1	1
2	2
3	3
4	4
5	5
6	6
7	7
8	8
9	9
10	10
11	11
12	12
13	13
14	14
15	15
16	16
17	17
18	18
19	19
20	20
21	21
22	22
23	23
24	24
25	25

(Male) (Male)

Figure B-5 01-00213-01 Cable

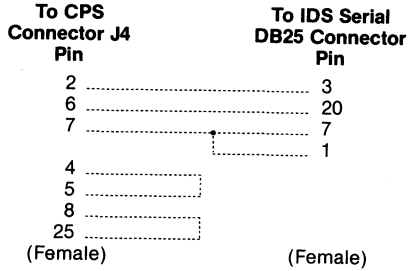

Figure B-8 01-00265-01 Cable

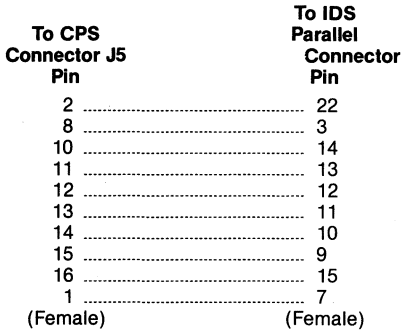

Figure B-6 01-00263-01 Cable

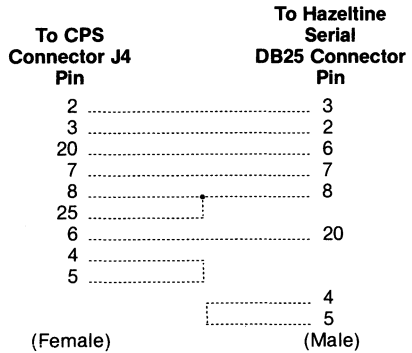

Figure B-8 B 01-00266-01 Cable

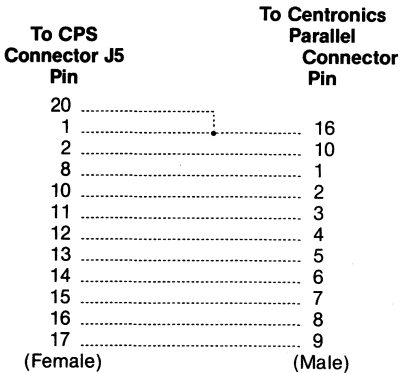

Figure B-7 01-00264-01 Cable

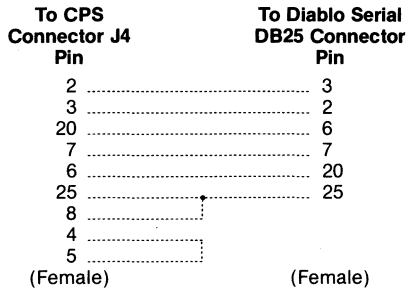

Figure B-9 01-00299-01 Cable

Appendix C

Troubleshooting

Error Messages

If when you tried to run the Setup program you got this message

**** INVALID RAM CONFIGURATION ****

A SET OF SYSTEM DEFAULT PARAMETERS IS NOW BEING LOADED.

The parameter information in the CPS Card memory has become unusable or has been destroyed. (Have your batteries come loose?) A new set of parameters was loaded.

If you got the above message followed by this one

**** UNEXPECTED FAILURE IN LOADING DEFAULTS. AN APPLE OR MULTIFUNCTION CARD PROBLEM IS SUSPECTED.**

your Apple or CPS Card may be damaged. Before you panic, turn the power off, and check that all your peripheral cards, including the CPS Card, are installed properly.

When all the connections are correct, turn the power on, boot the CPS Card diskette, and rerun the Setup program. If the problem persists, you may have a faulty diskette, or your Apple or CPS Card may be damaged. Call us at Mountain Computer Inc. before sending your CPS Card in for service.

If you tried to access a peripheral device other than a CPS device and one of the following malfunctions occurred:

- The system hung
- A "CANNOT FIND DEVICE" error message was generated
- A phantom device was activated instead of the device you expected

then you may have a phantom slot/physical slot conflict. Refer to Chapter 4 "Phantom Slots" for methods to de-assign the phantom slot.

Appendix D

Quick Reference

Sheet

Command Sequences (CTRL-W)

S — STOP processing command sequences
A — set current input device to clock, ALLOW
output through CPS
C — set current input device to CLOCK,
suppress output
I — set current INPUT device to serial
O — set current OUTPUT device to serial
P — set current output device to PARALLEL
D — DISABLE phantom slot feature
E — ENABLE currently established phantom
slots

Escape Codes (CTRL-I)

C — clear high order bit
S — set high order bit
E — enable auto line feed after carriage
return
K — disable auto line feed after carriage
return
L — pass lower case letters unmodified
U — lower to upper case conversion
R — regular video display mode
D — special inverse video display mode
O — turn off video output
V — video output enabled
T — absolute tabbing mode
B — regular tabbing mode
CTRL-A — change CTRL character to A
CTRL-I — change CTRL character to I
F — enter Terminal Mode, full duplex
H — enter Terminal Mode, half duplex

Terminal Mode Modifiers (toggles)

CTRL-SHIFT-P — transmit characters
transparently on/off
CTRL-A — auto line feed after carriage
return on/off
CTRL-B — set/clear high order bit
CTRL-C — case conversion on/off
CTRL-D — Dual Mode on/off
CTRL-R — exit Terminal Mode (no toggle)



Mountain Computer

INCORPORATED

Located in the Santa Cruz Mountains of Northern California, Mountain Computer, Inc. is a computer peripheral manufacturer dedicated to the production of use-oriented high technology products for the microcomputer. On-going research and development projects are geared to the continual supply of unique, innovative products that are easy to use and highly complementary in a broad variety of applications.



300 EL PUEBLO ROAD, SCOTTS VALLEY, CALIFORNIA 95066 (408) 438-6650 TWX: 910 598-4504
FOR PRODUCT SERVICE INFORMATION CALL (408) 438-4933