

APPLE II[®] COMPATIBLE

MUSIC SYNTHESIZER

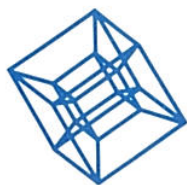

A L F PRODUCTS

The
**Apple Music Synthesizer
Owner's Manual**

Complete Instructions
for the
10-5-16
Apple Music Synthesizer

"the amazing thing about a Dancing Bear
is not how well he Dances;
but that he can
Dance At All"

Copyright © 1980
ALF Products Inc.
1448 Estes
Denver, CO 80215
U.S.A.

Part Number 11-1-6B
(Replacing the previous 11-1-6
and 11-1-7.)

The information contained in this manual was believed to be accurate at the time of publication. Although this manual has been carefully checked for accuracy by our inebrated technical staff, we assume no responsibility for errors or omissions. Independent verification of specifications is recommended in cases where this entertainment product is to be used or modified for use in other applications. ALF reserves the right to make changes in the product and/or specifications without notice.

this manual is dedicated to
all those who struggled along
with the previous version

Praise be to Xerox,
creator of the Diablo™ Hytype™;
but All Hope Abandon
ye who try to use the
Word Processing Enhancements
or the
Advanced Functions Groups

Project Engineers: Rick Harman, John Ridges, Philip Tubb.
Software Design: John Ridges, Forrest Thiessen, Philip Tubb.
Manual written by: Philip Tubb.
Manual graphics by: Rick Harman.
Automatic graphics by: John Ridges, Philip Tubb.
And 5 proofreaders who shall, for obvious reasons, remain nameless.

Please address all comments and suggestions to the appropriate person as indicated above.

"Apple][" is a registered trade mark of Apple Computer Inc.

CONTENTS

1. INSTALLATION

- 1-1 Installation
- 1-3 SLOT & UNITS chart
- 1-4 Operating tips
- 1-5 Problem checklist

2. INTRODUCTION

- 2-1 Block diagram
- 2-2 The INTRODUCTION program
- 2-3 Other programs

3. ENTRY

- 3-1 Entering a simple song
- 3-12 Correcting mistakes
- 3-15 Entering rests
- 3-17 Subroutines
- 3-20 Loading and saving songs
- 3-20 Adjusting the tempo
- 3-22 Envelopes
- 3-26 Recommended reading
- 3-27 Sample song breakdown
- 3-28 Summary of commands
- 3-28 Type 1 commands
- 3-31 Type 2 commands
- 3-34 Type 3 commands
- 3-35 Type 4 commands
- 3-39 Tips
- 3-41 Song data format
- 3-41 Selected hex addresses

4. PLAY

5. DISCO

6. PROGRAMMING WITH PERFORM

- 6-2 An example
- 6-3 A few precautions
- 6-6 Synthesizer initialization
- 6-6 Song configuration
- 6-6 Reading the "suggested speed"
- 6-7 Tempo control
- 6-7 A sample session
- 6-9 Technical
- 6-9 Type A commands
- 6-10 Type B commands
- 6-11 Type C commands

- 6-11 Song data
- 6-13 Tempo command
- 6-13 Temporaries
- 6-14 Command numbers
- 6-15 Block diagram

7. PROGRAMMING WITH CHROMA

- 7-1 Initializer
- 7-3 Partial initializer
- 7-3 Chroma
- 7-5 Pulse
- 7-6 Chroma example
- 7-6 Pulse example

8. PROGRAMMING BARE HANDED

- 8-4 Divisor calculation
- 8-5 Tuning

9. TIMING MODE

- 9-1 Connection
- 9-2 ENTRY & PLAY
- 9-3 Technical

10. LISTINGS

- 10-1 PERFORM
- 10-7 CHROMA

11. CIRCUITRY

- 11-1 Timing requirements
- 11-2 Signal descriptions
- 11-3 Access socket
- 11-3 TTL input requirements
- 11-3 Audio outputs
- 11-4 Schematic terminals
- 11-5 Schematics
- 11-7 Connector locations
- 11-8 Dimensions
- 11-9 Circuit card
- 11-10 Repair diagram
- 11-11 Component placement

This manual is published in a three-hole punched format, and is furnished with a reusable binder. Three-hole punched manuals have long been standard in the computer industry due to their versatility. They are easy to issue correction pages and addendums for, and the user can combine several manuals on similar topics into a single binder. ALF Products is proud to continue this fine tradition. We hope you will enjoy this format, and encourage other manufacturers to see the light.

1

INSTALLATION

make sure all 3 pins
go into the socket

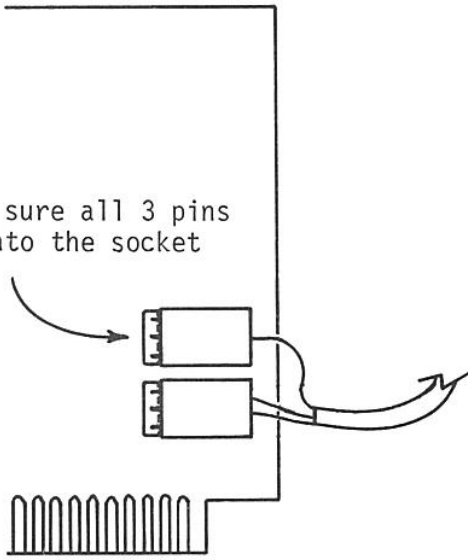

1 UNIT
MONO AND STEREO

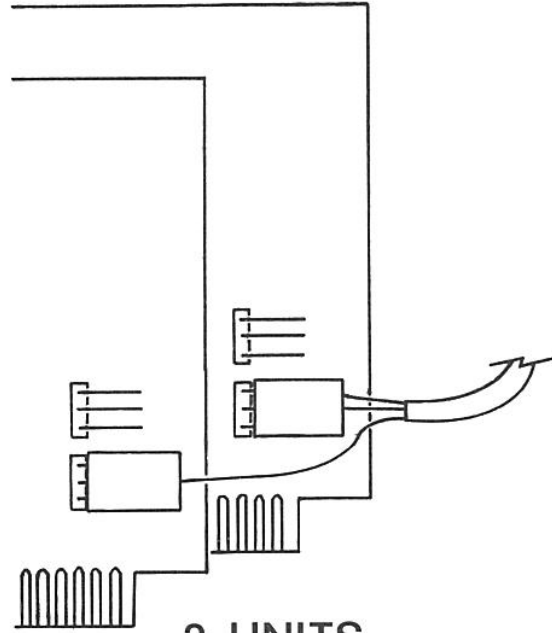

2 UNITS
MONO

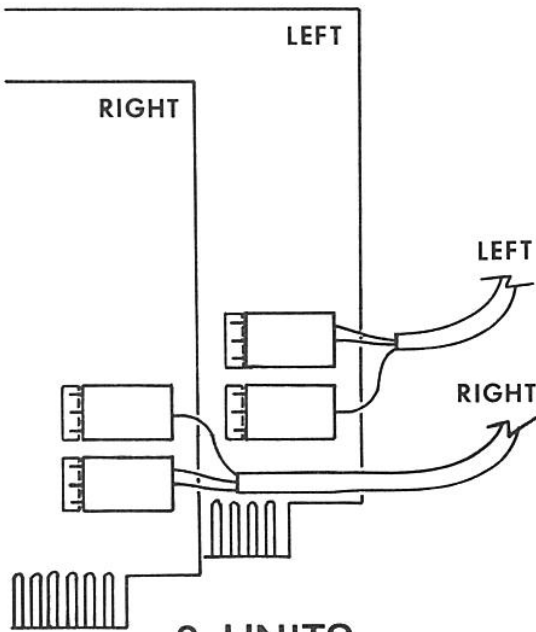

2 UNITS
STEREO

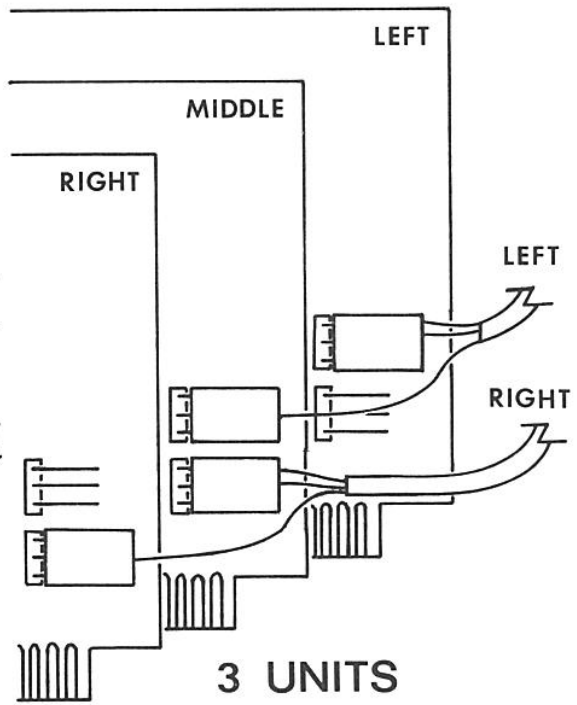

3 UNITS
STEREO

THIS MANUAL DOES NOT COVER USE OF THE APPLE II COMPUTER. READ THE MANUALS SUPPLIED WITH YOUR APPLE, AND FAMILIARIZE YOURSELF WITH ITS USE, BEFORE CONTINUING.

PLEASE READ THIS ENTIRE SECTION BEFORE BEGINNING.

Installation of your Apple II compatible music synthesizer is easy. Just follow these instructions:

1. You will need an audio amplifier and speakers or a home hi-fi system. One or two synthesizers can be used with a monophonic (mono) amplifier; and one, two, or three synthesizers can be used with a stereophonic (stereo) amplifier. Turn your amplifier off and the volume all the way down.
2. Turn the Apple off and remove the top cover.
3. Attach the audio output cable(s) to the synthesizer(s). One of the four drawings on the opposite page shows how the cables should be connected depending on how many synthesizers you have and what type of amplifier you're using. You'll notice that the connectors on the end of the audio cable can be plugged into the 3-prong connectors on the synthesizer circuit card in either of two ways: with the slots in the plastic housings toward the circuit card or away from it. You may plug them in either way. Just be sure all three prongs go into the three holes in the plastic connector.
4. Plug synthesizer(s) into expansion slot(s). Any slots may be used, but when using more than one synthesizer all slots used must be adjacent (see chart on next page). Route the cable(s) out through one of the holes in the back of the Apple. Replace the top cover of the Apple.
5. Plug audio cable(s) into amplifier or home hi-fi system. Any of a variety of inputs may be used, such as Aux (or Auxiliary), Tuner, or Tape Play. Do not use Phono (phonograph) inputs. When two or more units are used in a stereo system, connect one cable to the Left input and the other to the Right input of the same type (e.g. Aux left and Aux right) as indicated on the opposing page. When using one unit in a stereo system, use either left or right input; and set the amplifier to "mono" if desired. When using the synthesizer, set the amplifier to select the input used (Aux or Tuner, or Tape for "tape play" or "tape in").
6. The synthesizer is supplied with several programs, on cassette tape or on disk. These programs are written to run using Integer BASIC. (Optionally,

programs are available for use with Firmware Applesoft. In this manual, these will be referred to as the Applesoft versions although they will not work with the version of Applesoft supplied on cassette tape for use with Integer BASIC Apples. Note that when using Applesoft, FP must be typed anywhere this manual says to type INT.) Each program which uses the synthesizer has a line which contains information regarding the slot number of your synthesizer, and some also have the number of units being used. This line is always located at line 10. As supplied, all programs are for use with one synthesizer plugged into slot 4. If you are using more than one synthesizer, or if you have one synthesizer but it is not in slot 4, you will need to change some of the programs. Each program must be loaded, line 10 modified, and then saved. At the beginning of the instructions for each program in this manual the exact procedure required is explained. However, the variable SLOT (and sometimes UNITS) is used in each such procedure. To determine the value of SLOT and UNITS for your particular system, use the chart below.

		UNITS=1	UNITS=2	UNITS=3
SLOT=0	Synthesizers in slots:	0	0, 1	0, 1, 2
SLOT=1	Synthesizers in slots:	1	1, 2	1, 2, 3
SLOT=2	Synthesizers in slots:	2	2, 3	2, 3, 4
SLOT=3	Synthesizers in slots:	3	3, 4	3, 4, 5
SLOT=4	Synthesizers in slots:	4	4, 5	4, 5, 6
SLOT=5	Synthesizers in slots:	5	5, 6	5, 6, 7
SLOT=6	Synthesizers in slots:	6	6, 7	
SLOT=7	Synthesizer in slot:	7		

IMPORTANT: When changing line 10 you must load the program, change line 10 carefully making sure the length of the line is not changed, and then save the program. You must not save a program after it has been run, since it has then modified itself and thus will not contain many important statements which were originally present.

7. Turn your amplifier on. You are now ready to use the INTRODUCTION program. The INTRODUCTION section (which follows this section) contains instructions on running INTRODUCTION.

OPERATING TIPS

Plug your Apple and amplifier into the same electrical outlet if possible. Differences in ground potentials can cause difficulties when different outlets are used. If different outlets must be used, or if the amplifier does not have a three-prong (grounded) power cord, do this: when removing the synthesizer from the Apple, always unplug the audio cable from the amplifier first. Similarly, plug the synthesizer into the Apple prior to connecting the audio cable into the amplifier.

Always turn the Apple off before inserting or removing any circuit card.

Some of the parts used on the synthesizer are static sensitive. Protection against normal static levels is provided by other components on the circuit card. No part should be removed from the unit except the audio cable. Otherwise, damage could result unless special anti-static precautions are carefully followed.

Any Apple circuit board can be damaged by excessive static. This particular circuit board has been carefully designed to minimize the possibility of damage (since only LS TTL type inputs are connected to the edge connector). However, walking across a carpet while holding an Apple circuit card can "charge" you and the card to voltages high enough to damage any electronic circuit. Therefore, you should always hold the circuit card in one hand, and touch the metal case of the Apple power supply with the other hand prior to inserting a board in the Apple. This will allow the static charge to be drained through the third prong (ground prong) of the power cord, rather than through the circuit card and the Apple circuits.

Avoid dropping the synthesizer onto a hard surface or severely jolting the unit. Otherwise the crystal may be damaged.

Should your synthesizer ever need repair, return the entire unit (including the audio cable and software) to your dealer or to ALF. Your dealer can repair the synthesizer if he is an ALF-authorized service agent; otherwise he can return it to our factory service department for prompt attention. Replacement parts, such as a new audio cable or owner's manual, can be obtained from your dealer or from the factory.

PROBLEM CHECKLIST

1. Load the program you are using. List line 10. Is it correct? If not, refer to the instructions for the particular program being used.
2. If no sound is produced, check the audio cable connections. If one of the three conductor plastic connectors has only two pins going into it (and the remaining pin or prong is unconnected) there will be no output. If this is the case, unplug the connector and plug it in correctly.
3. Check connections to the amplifier and all switch settings on the amplifier. Do the amplifier and speakers work with other sound sources? If not, replace.

2

INTRODUCTION

The Apple Music Synthesizer is a simple three-channel synthesizer with direct hardware control of pitch and volume. Other effects can be produced with software. In normal use, each of the three channels is an identical and independent "monophonic synthesizer". A monophonic synthesizer is a musical instrument which can produce only one tone at a time ("mono"--one, and "phonic"--sound). Many conventional instruments are also monophonic. For example, trumpets, flutes, and clarinets can each only play one pitch at a time. In contrast, a piano can play several pitches at a time--unless you only use one finger. A piano is called a polyphonic instrument (from "poly"--many). The Apple Music Synthesizer is a polyphonic synthesizer since it can play three pitches at once, or up to nine simultaneous pitches using three synthesizers.

In order to create a synthesizer which is low cost, hardware control has been limited to control of pitch and volume. No other parameters can be controlled. Using software, pitch control can be used to create vibrato, sliding, or similar effects; and volume control can be used to create such effects as envelopes or tremelo. Since these are software-generated, in many applications it may be necessary to select only the most desirable effects to implement. The Apple may not be fast enough to perform the necessary calculations for all these effects, plus interpret a stored musical score, simultaneously. Note that waveform control is limited to square waves. (Pulse waves may be created in certain applications, see the CHROMA and BARE HANDED programming sections.)

A block diagram of the synthesizer is shown below:

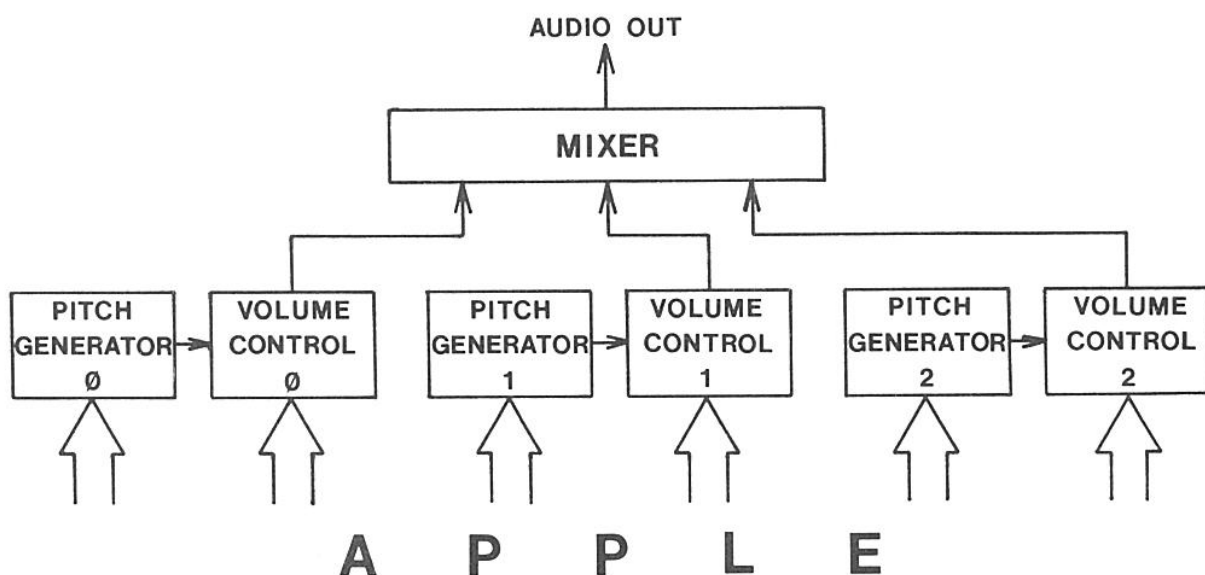

THE INTRODUCTION PROGRAM

A program named INTRODUCTION is supplied with the synthesizer. This program will introduce you to various technical terms used in music synthesis. Each term is explained and demonstrated with the synthesizer.

To run this program, you must have 24K or more memory. If you are using a DISK II, you need 36K or more. (Using the Applesoft version, these figures are 20K and 32K.)

First, load the program from disk or cassette tape. List line 10. It will be 10 SLOT=4. Find the proper SLOT value for your system using the table in the INSTALLATION section. Carefully retype the line changing only the digit 4 to the proper digit for your system. Now save the program on your disk. If you do not have a DISK II, save the program using your own recorder to improve loadability. The program is now configured for your system, and can be run any time you like without having to change line 10. If you ever change the slot position of your synthesizer(s), or purchase an additional synthesizer, you should do this configuration procedure again. (A note for perfectionists with three synthesizers: use a slot value one higher than normal to place the sound in the "middle".)

All instructions needed to run the INTRODUCTION program, once it has been properly configured as described above, will be displayed on the screen when the program is run.

OTHER PROGRAMS

ENTRY is the most advanced program supplied with the synthesizer. It is used to enter songs (usually from sheet music) and play them. Entered songs can be saved on (and loaded from) cassette tape or disk. Full editing features are available.

PLAY is used to play songs entered with ENTRY. Although ENTRY can also be used to play songs, PLAY has the advantage of being significantly shorter than ENTRY. Thus, it is faster to load and it allows songs entered on systems with more memory to be played even if they cannot be loaded with ENTRY. PLAY has no editing features, but it has a more general "play" command which, when used in conjunction with DISCO, allows songs to be played in sequence.

DISCO creates a text file (execute file) which, in conjunction with PLAY, allows songs to be played in a specified sequence. It can also randomize the sequence. When used with a Timing Mode Input Board or similar Timing Mode arrangement, whole "albums" of songs can be played back using a single command.

PERFORM is used from BASIC programs to play songs. Songs created with ENTRY (or by any other means) can be played back using a CALL within your own BASIC program. It can also be used to create complex multi-channel sound effects.

CHROMA is used from BASIC programs to create complex sounds. Effects not possible with ENTRY, PLAY, or PERFORM can be created using CHROMA, processor speed allowing. Although far more complex to use than any of the other programs, CHROMA allows access to virtually all functions available on the synthesizer.

Complete programming specifications for the synthesizer are presented in the **BARE HANDED** section. Those who wish to program the synthesizer "bare handed" (that is, without any ALF-supplied programs) will find the hardware programming specifications they need to write their own assembly language or BASIC programs in this section.

3

ENTRY

The ENTRY program is used to enter and play songs. Notes, rests, and other musical parameters are entered in a convenient sheet-music type format displayed on the screen (video monitor), and selected from a "menu" of available notes which is also shown on the screen. Songs entered can be stored on (and loaded from) cassette tape or disk. A variety of other functions are available for editing, stereo selection, and so forth.

To run this program, you must have 24K or more memory. If you are using a DISK II, you need 32K or more. (Using the Applesoft version, these figures are 32K and 40K.) Very detailed graphics are presented on the screen, so it is recommended that a black and white monitor (such as the Sanyo VM4209 or VM4215) be used rather than a television set, although good results have been obtained using the Sup'r'mod II UHF channel 33 TV interface unit (from M&R Enterprises) and the Sony Trinitron model KV 1513 color television.

First, load the program from disk or cassette tape. List line 10. It will be 10 SLOT=4 : UNITS=1. Find the proper SLOT and UNITS values for your system using the table in the INSTALLATION section. Carefully retype the line changing only the digits 4 and 1 to the proper digits for your system. (If you have a Timing Mode Input Board, list line 20. It will be 20 TSL0T=8. Carefully retype the line changing only the digit 8 to the slot number of your Input Board.) Now save the program on your disk. If you do not have a DISK II, save the program using your own recorder to improve loadability. The program is now configured for your system, and can be run any time you like without having to change line 10 (or 20). If you ever change the slot position of your synthesizer(s) (or Input Board), or purchase an additional synthesizer or an Input Board, you should do this configuration procedure again.

ENTERING A SIMPLE SONG

Load the program if it is not currently in memory. Type RUN and press return. The screen will go to hi-res graphics mode and display:

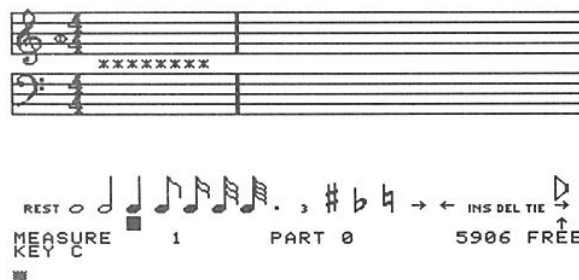

The number in front of "FREE" will vary according to memory size and other factors. It indicates the number of notes which can be added, and will be constantly updated as you enter and edit the song.

The first six measures of "America" are shown below:



In order to enter the piece using ENTRY, it is first necessary to break the piece up into "parts". Each part is an independent melodic line in which at most one note is played at a time. It is best to choose each part so it is consistently from the same melodic line in the music. This allows you to select appropriate envelope settings for each line later on. The first part, called Part 0, is shown below. It is the main melody.



To begin entering a new song, type NEW and press return. ENTRY will display "NUMBER OF PARTS?". Just press return. This will make the song have only 1 part (part 0). ENTRY now displays "SUGGESTED SPEED?". Since we don't really know what the playback speed should be yet, just press return. ENTRY will assume a speed of 255 (the slowest speed). ENTRY now displays "TITLE LINE 1". If you wish, you can type in a line which will be shown on the screen when the song plays. If you're not in the mood, just press return. The title lines can always be entered (or changed) later. ENTRY will then ask for title lines 2 through 4. Type titles if you like, or just press return for each line.

Part 0 can now be entered. Note that under "MEASURE 1" the screen shows "KEY C". If you turn paddle 1's knob, a small flying saucer will move up and down to the left of the two 4/4's. (If you get paddle 0 by accident, then a small arrow will move left and right instead. This doesn't matter. Try again with the other knob.) This flying saucer is called the "cursor", and it is very important. The cursor is a "pointer" to a particular item in the song. Currently, it is pointing to the KEY C before the 4/4. The key of C is a "neutral" key having no sharps or flats, and thus shows only as a blank space right before the 4/4.

Type KEY:1S and press return. A sharp sign will appear before the 4/4, and the cursor will move over to the 4/4. KEY:1S directs ENTRY to write a key signature of 1 sharp (S means "sharp", and F would be used for "flat"). This key signature is written over whatever item the cursor is on. Since it was on the KEY C, the

KEY C is overwritten with a KEY 1S.

When the KEY 1S is written, the cursor moves on to the next item in the song, which is a time signature of 4/4. The place on the screen which used to show KEY C now shows TIME 4/4 since the cursor is over the 4/4. "America" has a time signature of 3/4, so type TIME:3/4 and press return. The 4/4 will promptly change to 3/4, and the cursor will move on to the next item. The screen now looks like this:

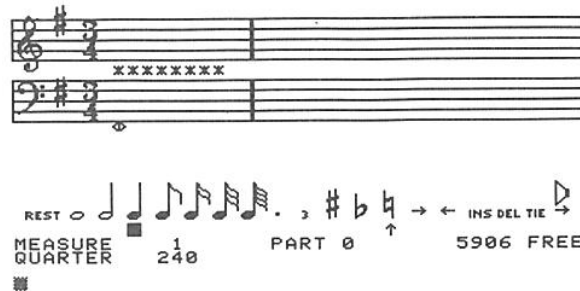

You've only been at this for a few seconds, and already you've told ENTRY two very important facts about "America", the song you're entering. Without these details it would be very difficult to enter the song properly. Why, you're probably half way to being a professional musician, if you weren't one when you started.

Now the cursor is at the first of eight asterisks (*) displayed between the treble and bass staves, and the item the cursor is at is a QUARTER 240. These eight items are special goodies that describe things about the song which don't display well in sheet music format. This particular one indicates how long a quarter note should play (240 time units per quarter note). While you will eventually want to learn about these, they are not important now, and it is best to skip over them at present. This is done using one of the paddles.

Turn one of the paddle knobs back and forth. If the arrow above "MEASURE 1 PART 0 5306 FREE" moves left and right, you're turning paddle 0, the "menu paddle". If the flying saucer cursor moves up and down, you're turning paddle 1, the "note paddle". Place the menu paddle (paddle 0) on your left and the note paddle (paddle 1) on your right. Usually you'll have your left hand on the menu paddle and your right hand on the note paddle; sometimes you'll have to let go of the paddles to type on the keyboard (probably not very often). Turning a paddle knob with one hand is almost always followed by pressing a paddle button with the same hand. You see, turning the knob selects something (a menu item when turning the menu paddle, or a note position when turning the note paddle), and then pressing the button tells ENTRY to look at the position of the knob and do whatever it is set for. Since the two paddles are used for different purposes,

you always press the button of the knob you have just adjusted in order to activate the function you adjusted the knob to indicate.

For example, using your left hand only, position the menu paddle so that the upward pointing selection arrow points to the right pointing arrow in the menu. The screen will look like this:



(The position of the flying saucer and the number of notes of FREE space available may be different than shown.) The right pointing arrow is used to move the cursor to the right. To cause a right movement, press the menu button using your left hand. The cursor will move right from an asterisk meaning QUARTER 240 to an asterisk meaning GAP 65535. To move the cursor right again, press the button with your left hand again. The cursor now moves to TRANSPOSE 0. Press the button several times. The following items will appear: ATTACK 8192, DECAY 50, VOLUME 55000, SUSTAIN 0, and RELEASE 50. (Most of these items specify an envelope. Envelopes are explained in the INTRODUCTION program.) Pressing the menu button again moves the cursor past the last of the 8 asterisks, and END appears under MEASURE 1 to indicate that the cursor is now at the end marker (that is, at the end of the song). This is where we will begin entering the notes of part 0. The screen should now look like this:



If it doesn't, you probably didn't start with RUN ENTRY like you should have. (The position of the flying saucer and the upward arrow, and the FREE number are not important.) Ready to really get into entering sheet music? Here's part 0 again, just as a reminder:



Using your right hand, turn the note paddle until the flying saucer is on the second line from the bottom of the treble staff, like this:



This is where the first note of part 0 should be. Still using your right hand, press the note button. A quarter note will appear at the second line, and the cursor will move over to the right. The pitch for that note is heard if you've got your synthesizer plugged in and your amplifier set up right. The screen now looks like this:



Normally when you type in something like TIME:3/4 or when you press the note button, the time signature (or note or whatever the cursor is pointing at) is written over and thus erased. However, erasing the end marker is not fun, so ENTRY automatically inserts the note (or whatever is entered) in front of the end marker. Then, when the cursor moves to the right, END is still shown under the MEASURE number since the end marker is still there.

It's time to give your left hand something to do for a while. Just for fun, position the arrow under the left pointing arrow in the menu (using the menu paddle, of course). Press the menu button. This will cause the cursor to move left. Under MEASURE 1, NOTE GN3 240 is displayed. That's the note you entered, a G Natural in the 3rd octave (the octave number is an ALF creation and has nothing to do with the rest of the world). "Natural" means it is neither sharp nor flat. The 240 indicates the number of time periods long the note should be during playback. (When you press the note button to enter a note, it is just

played for as long as you hold down the button.) Remember the QUARTER 240 that said quarter notes should be 240 time periods long? Well, they obviously are. Move the menu arrow so it is under the move right arrow and press the menu button. You're back to the end marker now. Isn't this exciting?

On to the second note. You've probably still got the note paddle set so the flying saucer is on the second treble line. (If not, move it until it is.) Press the note button. The next note is heard and appears on the screen. It is the same as the first note. Now, turn the note paddle until the saucer moves up one click to the space above the second line. Press the button to enter this note (are you doing all this note-paddle stuff with only your right hand?). Not only do you hear this note and see it on the screen, but also a bar appears between the note and the flying saucer. This is because TIME 3/4 means that there are 3 (3/) quarter notes (/4) in a measure. Since the measure is now full, ENTRY automatically shows a measure bar. You'll notice that there is a bar at this point in the sheet music, too. If ENTRY and the sheet music don't seem to agree on where to put the bars, then either the sheet music has a typo (that is, a wrong note) or you've skipped a note or made some other error. Just by watching the measure bars you can be confident that you haven't made any timing mistakes.

If you're looking ahead at the music for part 0, then you know that the next note isn't a quarter note. It's a dotted quarter note, which plays for as long as a quarter note plus an eighth note. (A dot always means to add the time of the next shorter note to the note length shown.) You may well be wondering why ENTRY always makes a quarter note whenever you press down the note paddle button. Well, it's because a block is lit up under the quarter note in the menu. When you press the note button, a note as long as selected in the menu (shown by one or more blocks) is entered. To change from a quarter note to a dotted quarter note, you position the menu arrow under the dot, which is just to the left of the "3", and press the menu button (left hand, remember?). A block instantly appears under the dot, and the block under the quarter note remains. The screen now looks like this:

REST ○ MEASURE 2 PART 0 5903 FREE INS DEL TIE

Okay, fire away. Move the note paddle down two clicks to the space under the second treble line, and press the note button. You see how you switch between

pointer to the rightmost menu item, a little speaker with a right arrow under it. Press the menu button, and a small block appears under the speaker/arrow. Curious? Position the arrow for right movement, and press the menu button five times to go past all the notes (do it fairly slowly, and pause a little extra at the dotted quarter note). You'll hear the first 5 notes of "America". The speaker/arrow activates playback during right movement. The timing of the notes is still dependent on how long you press a button down, but don't worry. It won't be during actual playback. You don't believe me, do you? All right, type PLAY and press return. ENTRY shows "SET SPEED (255) AND PRESS BUTTON". Crank the menu paddle up all the way (if may not actually get up to 255, but who cares?). ENTRY doesn't happen to mention which button you should press, but it is the menu button. Trust me. Punch it and ENTRY will play the song. A little slow, perhaps, but we'll know better next time.

Let's put in another note. I'll bet you're thrilled at the prospect. Just select a quarter note using the menu paddle, flash the note paddle up to the space above the second treble line, and punch the note button. Here's a screen image just to make sure we're together:

The image shows two staves of musical notation. The top staff is in treble clef with a key signature of one sharp (F#) and a 4/4 time signature. It contains a sequence of notes: a quarter note on G4, a quarter note on A4, a quarter note on B4, a dotted quarter note on C5, and a half note on B4. The bottom staff is in bass clef with the same key signature and time signature, and contains a series of asterisks (*****). Below the staves is a control display with the following elements: a 'REST' symbol, a 'MEASURE' indicator showing '3', a 'PART 0' indicator, and a '5900 FREE' indicator. To the right of these indicators are several symbols: a sharp sign (#), a flat sign (b), a treble clef, a left-pointing arrow, a right-pointing arrow, and a 'TIE' symbol.

Click up one to the third line. We're already set for quarter notes, so press the note button. Twice. Now, click up and press again (you should take a look at the music for part 0 again so you'll know what you're doing). That completes another measure. The display now shows MEASURE 4. This means the cursor is pointing to an item which is in the 4th measure. In this case, it is the end marker which is indeed in the 4th measure.

Faster now. Set for dotted quarter. Down a click and punch. Switch to eighth. Down a click and punch. Now quarter. Down a click, punch, up a click, punch, down, punch, down, punch. Last measure. Set for dotted half. (In case you haven't noticed, you can't set for "dot" and then "half" because "half" turns off "dot". Set "half" first, then "dot".) Okay. Up a click, and punch. We're out of music (just the first 6 measures, remember?). Are you getting fast at it yet? You will. It's easy. Let's see the screen now:



Type PLAY and press return. Let's try a speed of about 200 now. Adjust the menu paddle to some number in the vicinity of 200. (Don't get too picky, it's not important to get exactly 200.) Punch the button, and the first 6 glorious measures issue forth.

Rapture! Ecstasy! Sublime delight! (Where's my thesaurus?) Ah, the joys of music. And yet, that's just one part. Let's get on to THREE PARTS. Quick!

Fortunately, it is quick. First, we have to tell ENTRY that we want to add a second part. Type EDIT and press return. ENTRY responds by showing:



Since we want 2 parts, type 2 and press return. ENTRY then asks for the "suggested speed". Just press return to leave this as it was before. It will then display each of the four title lines. Just press return each time. The screen now shows:



This is the beginning of Part 0, the part you just entered. The part just created is Part 1. To see Part 1, type PART:1 and press return. The screen shows:

This is just like Part 0 looked originally, except there are fewer notes of "free" memory, and the screen shows "PART 1" instead of "PART 0". You now proceed in the same fashion as before. Type KEY:1S (return) and TIME:3/4 (return). The music for Part 1 is as shown below:

paddle since you've got that figured out already.) If there are any wrong notes, back up and correct them. (More details on correcting wrong notes will be given later in this section.) You're now ready to enter the third part.

Type EDIT and press return. Ask for 3 parts this time, and then press return to skip the other questions. When Part 0 appears, type PART:2 to go to the third part. The screen shows:

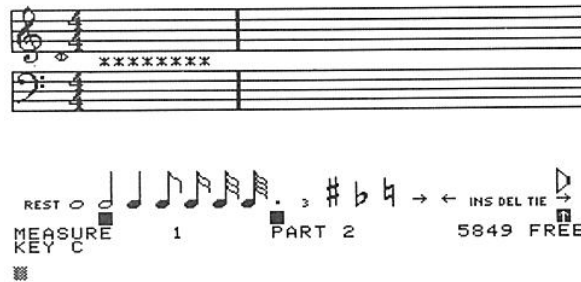

Begin as usual, typing KEY:1S and TIME:3/4, then skip the asterisks. Just for fun, type PLAY and press return. When you press the paddle button to begin playback, there is a brief flash and the hi-res graphics screen reappears. This is because the end of the highest numbered part (now Part 2) is reached immediately, since there are no notes entered in it yet. Now comes your big chance to use the "bass staff", which has been ignored up to this point. The bass staff is the lower five horizontal lines. The sheet music for Part 2 is shown below.



Enter the first note. The screen now shows:

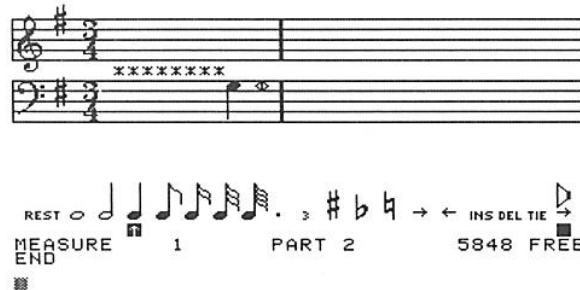

Enter the next nine notes. The screen shows:

The next note is sharp, so use the menu paddle to light up the sharp sign in the menu, like this:

Now enter the note. The sharp sign in the menu disappears into hyperspace:

Enter the rest of the part. The screen shows:

Type PLAY to hear the song and check for errors.

CORRECTING MISTAKES

Back up to the first note in measure 5 (of Part 2). Let's say we want to change

this note so it is at the next space up on the staff. First, set the menu notes for a quarter note, and put the cursor in the space above the note:



Now just press the note entry paddle button (paddle 1, of course). The old note is written over by the new note:



The rest of the song is not affected. Now, let's say we want to change the next note in the measure into a half note of the same pitch. Set for half note, position the cursor so it is over the quarter note's head (in order to get the same pitch), and press the button:



What if we want to get rid of the first note in measure 6 (where the cursor is now)? Just position the arrow for "DEL" and press the menu paddle button:

becomes a half note. (Note: the first time you pressed the button for "TIE", the cursor was not at a note or a rest, so the tie could not be done. Since you usually tie the last entered note, ENTRY backs up one when you do an illegal tie, allowing you to just press the button twice to tie the last note.) Now set the menu for a sixteenth note. Aim at "TIE" and press the button twice. The note is now a half note tied to a sixteenth:



The vertical position of the note paddle cursor is not important during a "tie" since the note paddle is not used. It is important to note that although the half note tied to a sixteenth note is shown as "two" notes, it is really only one. If you back up and look at it, you will see that the length shown is 540 time periods, which is a half (480) plus a sixteenth (60). In fact, the little curved line between notes always means that the multiple notes shown are really only one note. This happens on tied notes and on notes that have part of their duration in one measure and the remainder of their duration in the next measure. Tie in a sixty-fourth to the last note, and you'll see that more than two "notes" can be tied together to display a single note:



In general, mistakes are corrected (or any desired changes are made) by using the above functions (change a note, insert a note, delete a note, and tie additional duration to a note) until the screen shows what you want. When using these functions, only the current part is affected. In fact, the only functions available in ENTRY that affect anything besides the current part are the NEW, EDIT, STEREO, and SPEED commands which by their very nature must relate to the entire song.

ENTERING RESTS

On occasion a part must sit around for a while and not play anything. This is

called a "rest". Rests are entered in much the same fashion as notes. There are two main differences: the vertical position of the note cursor doesn't matter (since rests don't have any "pitch"), and the menu paddle is used to enter a rest, rather than the note paddle. Obviously, you point the menu arrow to "REST" and press the menu button to enter a rest. The duration of the rest is determined by the menu, just as the duration of a note is. Rests are displayed with different symbols than notes. They correspond like this:



Let's start on a new song. (Actually, "song" refers to a musical composition with lyrics. Technically, one shouldn't use "song" to refer to just any melody, but there isn't any simple word available. Musicians use "piece" or "work", apparently in an effort to avoid any disclosure that music is involved. In fact, all artists use "piece" and "work" to describe their creations.) Type NEW and press return. Press return 6 more times to avoid answering the useless questions. Skip over the key and time signatures, and the eight asterisks. Select quarter note, and press a REST. A quarter rest appears on the screen.



Now select sixteenth note duration and tie it onto the quarter rest. Oddly enough, the screen shows:



In traditional music notation, rests are never shown as being tied. This is because there is no difference between, for example, a half rest and two quarter rests during performance. The ENTRY screen display makes no distinction between a rest which is as long as a quarter plus a sixteenth, and two rests the

first of which is a quarter and the second of which is a sixteenth. However, it takes only one "right movement" to skip a single tied rest, and two to skip past two individual rests. (Plus, two rests would take twice as much memory as a single rest.) Incidentally, when a large number of rests are tied together (for example, in a part which doesn't begin playing until far into the song) the cursor will be at the last of the rests displayed, and the measure number will reflect the measure number the rest starts in. (This is true of notes, too.)

SUBROUTINES

Most people are familiar with the song "Row, Row, Row your Boat". If you're not, become so. This song plays the same theme several times, and from several parts. It seems that one would have to enter this theme several times. Since repeated sections such as this are common in music, ENTRY has special provisions for entering them. The sheet music for this song is thus:

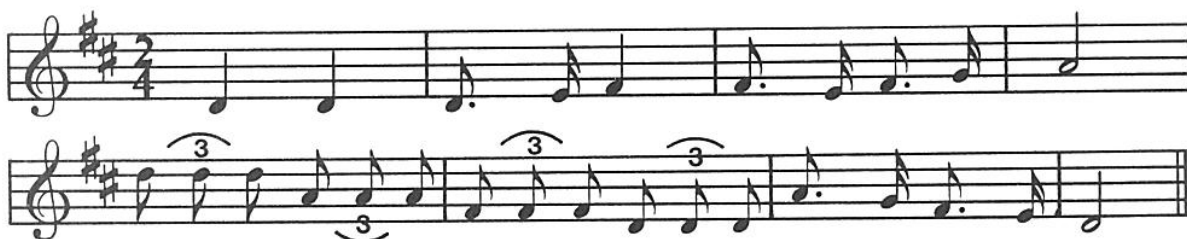

This theme must be entered in a special fashion which allows it to be played many times. This is done using a subroutine. Type NEW and press return several times (as usual) to start fresh. Now type SUBROUTINE:Ø and press return. The screen will show:

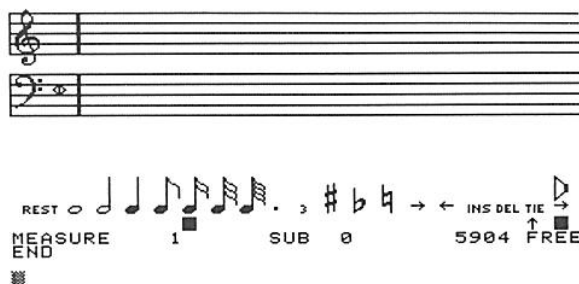

Type KEY:2S and TIME:2/4 to enter the key and time signatures. (Otherwise KEY:C and TIME:4/4 are assumed.) Enter the first four measures of the theme in the usual fashion. You'll notice that the next note is a triplet. Triplets are entered in the same fashion as dotted notes. Just light up the block under the "3" after selecting eighth note. Now press the note paddle button to enter the note. The screen will show:

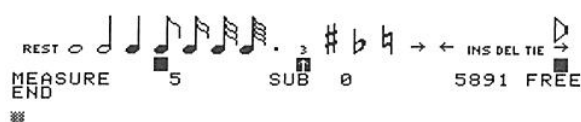

The little 3 above the note indicates that it is a triplet. Conventional sheet music notation shows triplets with a curved arc above the three notes and a single 3. ENTRY puts a little 3 above each note. This is because ENTRY, unlike conventional notation, allows the presence of a single triplet note (that is, a single note with a duration equal to one of the notes of a conventional triplet set). Press the note button twice more to enter the remaining two triplet notes of that pitch, then enter the remaining three sets of triplets, and the rest of the theme. The screen will show:

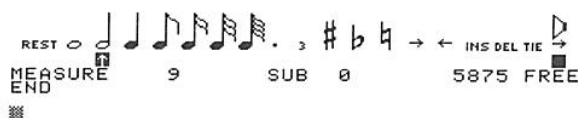

Now type PART:Ø and press return to go to Part Ø. Type KEY:2S and TIME:2/4 as usual, and skip the 8 asterisks. Now type CALL:Ø and press return. A 9th asterisk appears. During playback, this CALL causes the theme entered into its associated subroutine to be played. (CALL:1 would play the theme entered into SUBROUTINE:1.) Type PLAY and press return. The basic theme is played. Now, type in another CALL:Ø after the first one. Type PLAY again and note that the basic theme is played twice.

Now EDIT the song to 2 parts. Type PART:1, KEY:2S, and TIME:2/4. This time, instead of skipping the 8 asterisks, step forward until TRANSPOSE Ø is shown. If we played the basic theme exactly the same in both parts, they would be hard to tell apart. So, type TRANSPOSE:24 and press return. The TRANSPOSE Ø is of course thus changed to TRANSPOSE 24. The transpose function raises all following pitches by the specified amount of quarter steps. There are 24 quarter steps per octave (2 quarter steps is the difference between two adjacent keys on a piano, including both black and white keys), so TRANSPOSE:24 will cause this part to be played one octave higher in pitch than the other part. Skip over the remaining asterisks. Part 1 is supposed to begin after Part Ø has already

been playing for two measures. Select a whole note duration and enter a rest. It will show as two half rests due to the 2/4 time signature. Now type in two CALL:Ø's. Type PLAY. A two-part round will be played.

Let's add a third part. EDIT the song to 3 parts. Type PART:2, KEY:2S, and TIME:2/4. Skip to the TRANPOSE setting again. Let's shift this part down one octave. Oddly enough, to transpose down you take the number of quarter steps you wish to transpose down, and subtract that number from 256. 256-24 is 232, so type TRANPOSE:232. Now skip past the other asterisks. Punch in a whole rest, then press TIE twice to make it two whole rests (which will display as four half rests, again due to the time signature). Type in the usual two CALL:Ø's. Now just type PLAY to hear the full three-part round.

Perhaps you've noticed that you really didn't need the KEY:2S's in the three parts, since there aren't any notes anyway. You could have simply deleted the key signature if you prefer. However, often there are notes in the part, and in that case the key signature would be needed. In this particular instance, even the time signature could have been deleted without affecting the song. Naturally, the KEY:2S was needed within the subroutine, else the notes of the song would be incorrect.

Here are a few things you should know about subroutines. You can have 100 subroutines numbered Ø through 99. Always begin with subroutine Ø and proceed by 1's. If you press RESET, or if you save a song and load it again, all the subroutine numbers will be readjusted so they do begin with Ø and proceed by 1's. A subroutine is created when the first SUBROUTINE command using its number is entered. All subsequent SUBROUTINE commands with that number merely cause the subroutine to be displayed and to be available for editing. (That is, the first SUBROUTINE command for any given subroutine is like the EDIT command for new parts. All future SUBROUTINE commands are like the PART command for parts.) Once created, a subroutine cannot be destroyed. The most you can do is delete everything in it. A CALL can be entered only to an existing subroutine. (That is, you can't even enter a CALL to a subroutine you haven't created yet.) Subroutines are not limited to notes and rests. You can put a TRANPOSE function in a subroutine, for example. Some things, like key and time signatures, can be put in a subroutine to affect the notes entered in the subroutine, but they do not affect the notes entered outside the subroutine, even after a CALL to the subroutine. The summary of commands in this section tells the effects of each command.

Subroutines can be used in a much more complex fashion than shown in this simple example. For example, subroutines can contain CALLs to other subroutines. If a subroutine contains a CALL to itself, the song will repeat forever (unless

the highest numbered part does not use a subroutine which CALLs itself, in which case the song will stop whenever the highest numbered part stops). NOTE: be sure there is at least one note or rest in a subroutine that CALLs itself; otherwise the playback routines will not continue processing all parts.

LOADING AND SAVING SONGS

If you want to save Row, Row, Row then you should type SAVE and press return, if you want to save it on cassette tape. When saving a song to disk, it is necessary to specify a name. For example, you could type SAVE:ROW and press return. Names can contain any characters except comma, and can be up to 28 characters long. (Control letters and trailing spaces are ignored.) Disk specifications like ",D2" or ",S3,D2" can be added after the name if needed. Note that songs will appear in the catalog as Integer BASIC programs (even if your system doesn't have Integer BASIC) and will have names that begin with "M:". Songs are loaded the same way, using LOAD instead of SAVE.

The synthesizer is supplied with a few sample songs which can be loaded and played. Additional songs are available at extra cost.

ADJUSTING THE TEMPO

Let's say we want to enter the "row" theme to play twice as fast with the same paddle setting. That means each note will have to play for half as many time periods. Type NEW and press return as required, enter the key and time signatures, and you'll be at the QUARTER 240 function. Type QUARTER:120. This will make all quarter notes be entered as 120 time periods instead of 240 (and thus take half the time, so the song will play twice as fast). The other menu notes' duration values will change proportionately. Skip over the other asterisks and enter the theme. Now type PLAY and use the same paddle setting as you did previously. The song does indeed play twice as fast. Type PART:0 to get back to the beginning of the part, and skip over to the QUARTER function. Change it back to QUARTER:240. You'll notice that all previously entered notes show as notes half as long as originally entered. Examine any note by moving the cursor to it. Notice that the length in time periods is still the same. You didn't change any of the notes, only the QUARTER function, so of course none of the notes have been altered. Obviously ENTRY stores notes based on their "time period" length, and just computes the proper note to display based on the QUARTER setting. (And the QUARTER setting determines the "time period" length of notes when they are entered.) Since none of the notes have been changed, the song will still play as it did before. In fact, you can skip right a measure or two (you might want to look up the MEASURE command in the summary of commands) and insert a QUARTER:120. Notes before the QUARTER function will be shown as half as long as originally entered due to the QUARTER:240, and notes after the QUARTER:120 will

be shown as entered. None of this affects playback, but any new notes you might enter would be based on the current QUARTER setting. Remove the inserted QUARTER, if you put one there, and change the QUARTER at the beginning to QUARTER:120 as it was when the notes were originally entered. Now type SPEED:2 and press return. This will multiply the "time period" lengths of all notes in all parts and subroutines by 2. Rest durations and QUARTER settings are also multiplied by the specified amount. Now the song plays twice as slow (also known as half as fast). In fact, it should look just like the original QUARTER:240 version, except that it used a subroutine and multiple parts. (CAUTION: the SPEED command can be tricky to use. See the complete description in the summary of commands.)

By typing in a QUARTER function wherever you need a different tempo, you can make the song play at different speeds from section to section. Just remember that the QUARTER function affects only notes which haven't been entered yet. Another way to get unusual note durations is by using the LENGTH command. Let's say you want to play five notes in the space of a single quarter note. A standard quarter note is 240 time periods long, so each of your five notes will have to be 240/5 or 48. Unfortunately, there aren't any menu notes that are 48 time periods long. So, type LENGTH:48. The block(s) under the menu notes disappear to indicate a non-standard note length. All notes (and rests) you enter now will be 48 time periods long. Give it a try by making a new song and punching in five notes. The screen should look like this:

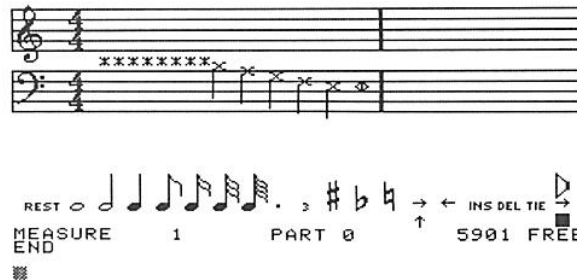

Since there is no representation for a note 48 time periods long, each note has a small X. To cease entering non-standard notes or rests, just activate any menu note. For example, put the menu arrow under the half note and press the menu button, then do the same for the dot (".") to select a dotted half note. Punch in a note, and the screen shows:

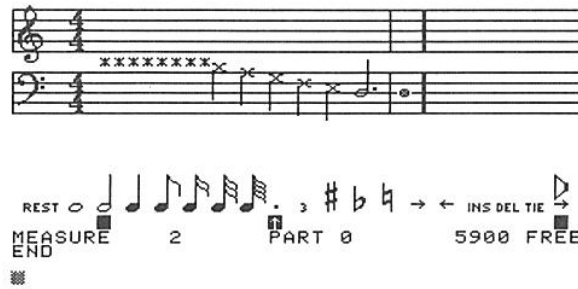

The measure bar shows that a full 4 quarter notes worth of duration have occurred, verifying that the five funny notes took up one quarter note of time.

ENVELOPES

Envelopes are a little complicated, and to really get the most out of your synthesizer is going to require a little study, some effort, a fair amount of calculation, and an awful lot of experimenting. Let's start at a very simple level. If you aren't completely familiar with standard synthesizer envelopes, run the INTRODUCTION program (see the INTRODUCTION section). Now that you're familiar with the terminology, here's how it applies to the various envelope commands. They are ATTACK, DECAY, SUSTAIN, RELEASE, VOLUME, and GAP. The first point of possible confusion is with the VOLUME function. It does not set the output volume like a volume control would. It sets the maximum loudness level reached during the attack stage (that is, the point at which the switch from the attack stage to the decay stage occurs). Both VOLUME and SUSTAIN specify a loudness level. SUSTAIN:0 selects a very low level (soft), and SUSTAIN:65535 selects a very high level (loud). ATTACK, DECAY, and RELEASE specify a rate of change. ATTACK:0 selects a very slow increase rate, and ATTACK:65535 selects a very fast increase rate. (Actually, 1 is very slow. 0 is stopped, or no change.) A blank song created with the NEW command contains some envelope settings which are useful for testing songs. Usually you enter the basic notes of a song, play around with the tempo (playback speed) if necessary using SPEED commands and/or different QUARTER settings, and once you're satisfied with the tempo you go on to the envelope settings. This is because the SPEED command doesn't change any of the envelope settings. If you perfected your envelope settings and then used a SPEED command, the envelopes would no longer be perfect. This is needlessly complex to correct, so it is best to get the tempo going right before starting in on envelopes.

To change the initial envelope settings, just position the cursor at the appropriate setting and type in a new value. For example, if you wish to have a slower attack rate, you might position the cursor at the ATTACK 8192 and type ATTACK:7800. Few songs use the same envelopes on all parts or even the same envelope throughout any particular part. At any point in a part, you can just

"insert" new envelope parameters. During playback, the most recent setting (for each part) is used for envelope production. Since there are notes (and rests) between one envelope specification and another, the playback routines will not "see" the later specifications in the part until the note before them is finished. When they finish a note, they look at the next thing in the part. If it's not a note or a rest, they make whatever change is requested (a new attack value, for example) and then continue with the next thing in the part (until a note or rest is finally found).

GAP is not mentioned in the INTRODUCTION program. Further, the INTRODUCTION program claims that the sustain stage of the envelope lasts "as long as desired". Usually, on a synthesizer or a piano, the sustain stage ends (and the release stage begins) whenever the key being pressed is released (hence the word "release", obviously). There aren't any keys to release in the music data. So, the GAP function is used. It is used to specify how long before the next note begins the release stage should begin. For example, using QUARTER:240 settings, a whole note (960 time periods) played with a GAP setting of 240 would have three quarter notes (960-240, or 720 time periods) worth of attack, decay, and sustain; then one quarter note (240 time periods) worth of release. A rest automatically starts the release stage if it wasn't already. Notes shorter than the GAP setting have no release stage unless followed by a rest. GAP:65535 is used when no automatic release stage is desired.

Now is the time for all good men to experiment with envelope settings. Don't come back to this manual without experimenting for at least 7 million time periods.

You are now ready for the serious explanation of envelope production. Although theories change from time to time, today's leading scientists in enveology agree on the "wandering loudness" explanation. This one seems to fit the reality of the synthesizer most closely. The two main ingredients of this are "current loudness" and "desired loudness". The current loudness refers to a number which ranges from 0 to 65535. This number divided by 256 is the actual volume setting on the synthesizer at the moment. The desired loudness is also a number from 0 to 65535. The current loudness is "attracted" to the desired loudness, so it attempts to get closer and closer to it. Once each time period, the current loudness can increase by an amount less than or equal to the attack setting, or it can decrease by an amount less than or equal to the "current decay" setting. (Not to be confused with the "decay setting".) In this fashion, it will arrive at the desired loudness as quickly as the attack/current decay settings permit. Once the current loudness collides with the desired loudness, the desired loudness spontaneously changes to a new value, called the "current sustain level" (not to be confused with the "sustain setting"). Probability states that the new

desired loudness may be different than the current loudness (although the current loudness is equal to the old desired loudness), so the current loudness must again seek the desired loudness. This astounding natural process continues at all times during playback. The current loudness cannot be affected directly, so it must be "guided" by selecting appropriate parameter settings.

Notetrinos generated using a high-power paramatron at the University of Northern South Dakota (just across the border from Hoople) have revealed the following characteristics of these settings. (What?) When a new note begins, the most recent decay setting is written into the "current decay" rate, the most recent volume setting is written into the "desired loudness", and the most recent sustain setting is written into the "current sustain". This causes the attack and decay stages of the envelope to occur, since the current loudness (and thus the synthesizer volume) will raise (at the attack rate) to the selected volume level, at which time the sustain level becomes the new desired loudness, causing the current loudness to drop to the sustain level (at the decay rate). Once the sustain level is reached, the desired loudness stays constant (since it is equal to the current sustain setting which would normally become the new desired loudness) and thus the sustain stage of the envelope occurs until something changes.

Something changes when either (a) the time remaining for the current note equals the most recent GAP setting, (b) a rest is encountered, or (c) a new note is encountered. Case (c) has already been discussed (above). In either case (a) or (b), the release stage must begin. This is done by writing the most recent release setting into the "current decay" and a zero into the "desired loudness" and "current sustain". The current loudness (and, again, thus the actual synthesizer volume) then naturally drops to zero at the selected release rate.

This simple process generates a variety of complex envelopes, for single notes or for several. Be ye not confused: each note does not necessarily have an "attack" and "decay" stage (and so forth). In fact, if the current loudness is greater than the latest volume level when a new note begins (for example, the volume setting was just lowered drastically before this note, and the previous note had been at a very high volume with too slow a decay/release rate to drop very far), the note would begin with a "decay" stage, since the current loudness would have to go down to intercept the desired loudness (which would be the new volume level). Thus, the envelope parameters are not limited to a single note. In general, however, one will arrange the parameters so the envelope will be limited to a single note.

Some examples are in order. Let's say we want a simple AD (attack-decay, or "ping") envelope with a volume level of 55000. Further, let's say it is a quarter

note with standard QUARTER settings (240 time periods) and we want the first 16th of the note to be the attack stage, and the remaining 15/16ths to be a full decay. The attack rate will have to be designed to take the current loudness from 0 to 55000 in 240/16 time periods. $55000 / (240/16)$ is 3666.67 so we want an attack setting of 3667. The decay rate will have to take the current loudness from this peak of 55000 back down to 0 in $240 * 15/16$ time periods. $55000 / (240 * 15/16)$ is 244.44 so we want a decay setting of 245. The loudness contour will appear thus:

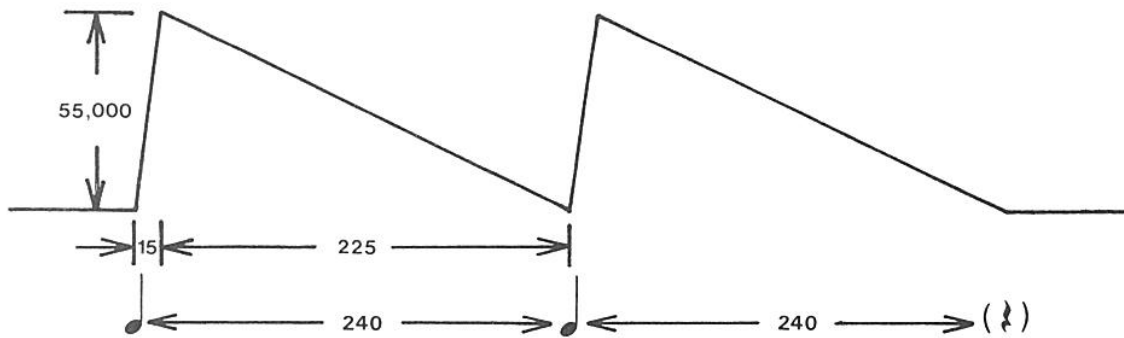

The GAP setting must be 65535 to avoid a release stage. Now, what if we played an eighth note with this setting? The loudness contour would appear thus:

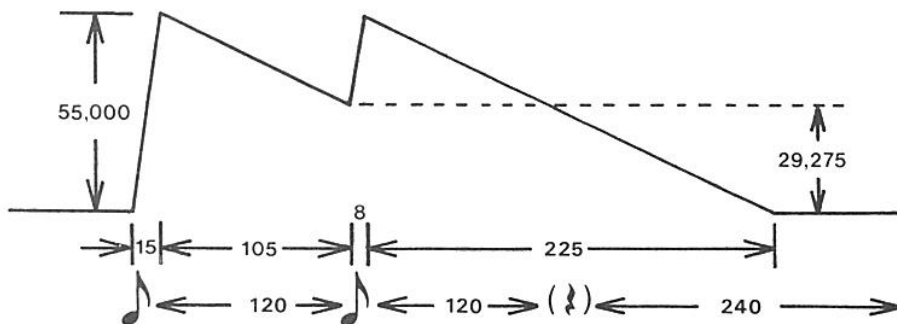

If an eighth note is followed by a rest, the release stage will begin. Therefore the release setting should be set to the same as the decay setting, unless you want something different to happen on notes followed by rests. What if we played a whole note? Behold:

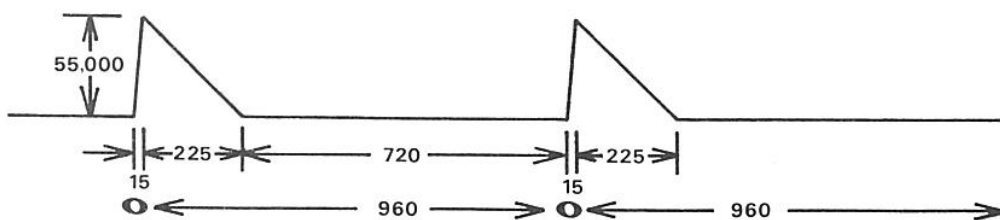

This assumes the sustain level was set to 0. What if it were 45000?:

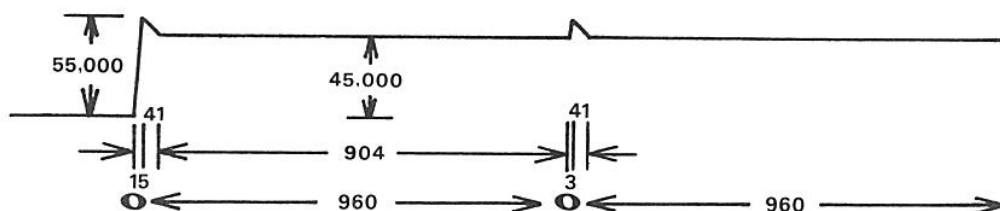

This is almost an ADSR (attack-decay-sustain-release) envelope. All we need is release. Let's say we want it to take half as long to release as the quarter note example took to decay. That means we'll need a release rate which is twice as fast, or $2 * 245$ which is RELEASE:490. Now, it will take $45000 / 490$ time periods for the current loudness to drop from 45000 (the sustain level) to 0, so we need a GAP setting of $45000 / 490$ (which is 92) or greater if we want the release to go clear down to zero. That looks like this:

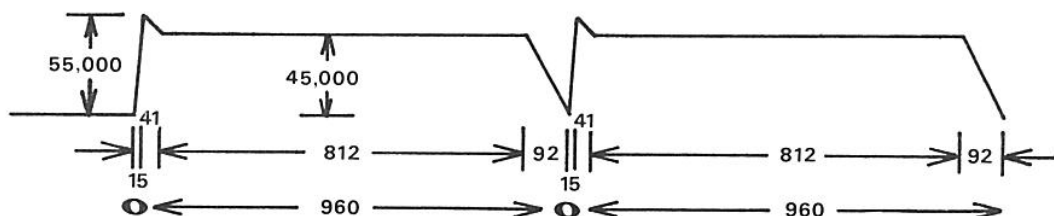

The sustain level need not be less than the volume level. For example, with a sustain level equal to the volume level, you get an attack-sustain-release envelope (organ like, using fast attack and release rates).

Experiment more with the settings. Draw graphs like the ones above if they help you. Look at other people's envelope settings if you run out of ideas. Here's a real tip: program what would normally be a whole part into a subroutine instead. Then you can call it from two parts, and use different envelope settings on each part (don't put envelope settings in the subroutine!). This will let you make more complex sounds, especially using different transpose settings or by putting a short rest before the CALL in one of the parts to delay it slightly (for an "echo" effect) or both.

RECOMMENDED READING

For those of you who are unfamiliar with standard sheet music notation, or for those who encounter some particularly obscure notation, there is an excellent book which you can order from any bookstore. Just ask your local store to order "Music Notation, A Manual of Modern Practice" by Gardner Read, Taplinger Publishing Co. ISBN 0-8008-5453-5. In the unlikely event that you have no local bookstores, you can order it from ALF (part number 11-2-1).

J. S. Bach

Bist du bei mir, geh ich mit Freu-den

A musical score for J.S. Bach's 'Bist du bei mir'. It features a vocal line in treble clef and a piano accompaniment in grand staff (treble and bass clefs). The key signature is B-flat major and the time signature is 3/4. The lyrics are written in italics below the vocal line.

BECOMES:

PART: 0

*
(additional *'s ommited for clarity)

A single musical staff in treble clef, 3/4 time, B-flat major. It contains the first measure of the vocal line from the original score, marked with an asterisk.

PART: 1

*

A single musical staff in treble clef, 3/4 time, B-flat major. It contains the second measure of the vocal line from the original score, marked with an asterisk.

PART: 2

*

A single musical staff in treble clef, 3/4 time, B-flat major. It contains the third measure of the vocal line from the original score, marked with an asterisk. The staff is followed by a dashed line indicating continuation.

PART: 3

*

A single musical staff in treble clef, 3/4 time, B-flat major. It contains the fourth measure of the vocal line from the original score, marked with an asterisk. The staff is followed by a dashed line indicating continuation.

PART: 4

*

A single musical staff in bass clef, 3/4 time, B-flat major. It contains the first measure of the piano accompaniment from the original score, marked with an asterisk.

SAMPLE SONG BREAKDOWN

SUMMARY OF COMMANDS

ENTRY has four types of commands. They are:

1. Commands which are done immediately and have no effect on the song data.
2. Commands which are done immediately and have an effect on the song data.
3. Commands which are stored in the song data and do not affect playback directly.
4. Commands which are stored in the song data and do affect playback directly.

All commands, except those entered using the paddles, are typed in using the Apple keyboard in the following fashion. Each command has a "keyword", for example NEW or VOLUME. Some commands have one or more parameters, in which case the keyword is followed by a colon (:) and the parameter, for example VOLUME:55000. Thus, a command is always entered by typing the keyword and pressing return; or by typing the keyword, a colon, one or more parameters, and pressing return. (Do not type any spaces.) Since the keyword is always followed by a return or a colon, ENTRY has been written to allow abbreviation of the keyword. You can shorten any keyword as much as you like, as long as there are still enough letters to tell it apart from any other keyword. For example, INTEGER can be shortened to just I since no other keyword starts with I. SUBROUTINE can be shortened to SUB, but not to SU since it could then be either SUBROUTINE or SUSTAIN. An example of a complete abbreviated command is SUB:Ø instead of SUBROUTINE:Ø. The right and left arrows on the Apple keyboard can be used to backspace and to forward space for error correction. When return is pressed, only letters to the left of the flashing cursor are considered part of the command, other letters are ignored. Control X can be used to clear the line and start over.

In the bold type for each command, anything inside <broken brackets> is an explanation rather than something to be typed literally. Anything inside [brackets] is optional.

TYPE 1 COMMANDS

These commands are done immediately. The song data is not changed at all.



The seven note duration symbols, plus "." and "3", are used to select a new note entry duration. (See REST and PADDLE 1 under Type 4 Commands.) They are requested by pressing Paddle Ø's button while the upward-pointing arrow is aiming at the desired symbol. When one of the seven note duration symbols is requested, a block is lit under it. All other blocks under note duration symbols

(including "." and "3") are turned off. When "." is requested, the block under it changes (becomes lit if it wasn't, or is cleared if it was lit). When "3" is requested, the block under it changes.



The three accidental control symbols are used to select accidental control for future note entry (see PADDLE 1 under Type 4 Commands). They are requested by pressing Paddle 0's button while the upward-pointing arrow is aimed at the desired symbol. When one of the accidental control symbols is requested, the block under it is changed (becomes lit if it wasn't, or is cleared if it was lit) and the blocks under the other two accidental control symbols are cleared.



The left and right movement controls are used to move the cursor left or right. They are requested by pressing Paddle 0's button while the upward-pointing arrow is aimed at the desired symbol. When one of the movement control symbols is requested, the cursor will move one item in the indicated direction. Movement to the left of the first item in a subroutine or part is not allowed. Movement to the right of the end marker in a subroutine or part is not allowed. When a movement is requested which is not allowed, the request is ignored and the Apple speaker will beep.

INS

The insert symbol is used to turn insert mode on or off. It is requested by pressing Paddle 0's button while the upward-pointing arrow is aimed at INS. When requested, the block under INS is changed (becomes lit if it wasn't, or is cleared if it was lit). "Insert mode" is on when the block under INS is lit, or when the cursor is at the end marker of a part or subroutine. All Type 3 and Type 4 Commands are affected by insert mode.



The speaker/arrow symbol is used to select playback during forward (right) movement. It is requested by pressing Paddle 0's button while the upward-pointing arrow is aimed at the speaker/arrow symbol. When requested, the block under the symbol is changed (becomes lit if it wasn't, or is cleared if it was lit). When lit, notes moved past with the right movement symbol, and notes deleted with the DEL symbol, are sounded through the synthesizer.

GOTO:<0-8>

The GOTO command is equivalent to the PART command (a Type 1 Command) except

that a MEASURE command (a Type 1 Command) is automatically performed after the indicated part has been selected. The measure number used for the MEASURE command is whatever measure number was displayed on the screen at the time the GOTO command was entered. Sample command: GOTO:1 (return).

INTEGER

The INTEGER command is used to exit ENTRY and return to BASIC. The current song data is lost. ENTRY cannot be run again without first being reloaded. Note that when using the APPLESOFT version, the INTEGER command is used to return to BASIC, but APPLESOFT BASIC will be returned to rather than Integer BASIC.

LENGTH:<Ø-65535>

The LENGTH command is used to select a non-standard note duration. (See PADDLE Ø and PADDLE 1 under Type 4 Commands.) When entered, all blocks under the seven note duration symbols and under "." and "3" are cleared. The indicated duration is saved for future note and rest entry use. Sample command: LENGTH:48 (return).

MEASURE:<Ø-65535>

The MEASURE command is used to view a particular measure within a part or subroutine. The cursor moves to the first item within the specified measure number. MEASURE:Ø is equivalent to MEASURE:1. If no such measure exists, the cursor is moved to the end marker of the part or subroutine. Sample command: MEASURE:249 (return).

PART:<Ø-8>

The PART command is used to view a particular part (and thus select that part for possible editing). The cursor moves to the first item in the selected part, or to the end marker for that part if there are no items in the part. Sample command: PART:1 (return).

PLAY[:F]

The PLAY command is used to perform the current song (using a modified version of the PERFORM program). A simple low-res color display is shown during playback. In this display, each part has a blue horizontal line. In this line is a yellow dot which marks the position of middle C for that part (this dot will not be present when playing very high pitched notes). This middle C marker slides left and right one or more octaves if necessary to show whatever pitch range is currently being used. Above the horizontal line, a block is shown which indicates the pitch being produced. Higher pitches are to the right of the display. The color of this block indicates the approximate "current loudness" of the pitch as follows: Ø-4Ø95 black, 4Ø96-8191 magenta, 8192-12287 dark blue, 12288-16383 purple, 16384-2Ø479 dark green, 2Ø48Ø-24575 grey, 24576-28671 medium

blue, 28672-32767 light blue, 32768-36863 brown, 36864-40959 orange, 40960-45055 grey, 45056-49151 pink, 49152-53247 green, 53248-57343 yellow, 57344-61439 aqua, 61440-65535 white (loudest). (Based on Apple's suggested color names; actual colors may vary.) Ignoring the fact that there are two colors named grey, each color represents any of 16 different actual volume settings on the synthesizer, since there are only 16 colors for 256 settings. PLAY:F performs the current song using the PERFORM program (that is, with no display). NOTE: both PLAY commands change (a) the CHANNEL function settings and (b) the subroutine FE bytes. These changes will not be apparent to the ENTRY user, but could affect PERFORM users. See the PERFORM section for additional information. Sample command: PLAY (return).

SAVE[:<song name>[<disk specifications>]]

The SAVE command is used to write the current song data on cassette tape (or whatever might be connected to the Apple's cassette output jack) or on disk. SAVE saves the song to cassette tape. SAVE:<song name>[<disk specifications>] saves the song to disk. Both commands are used in the same fashion as the SAVE commands in BASIC. One exception: song names may contain 0 to 28 characters, including any character except comma (for any character, including the first); control characters and trailing spaces are ignored, but leading spaces are not. Sample command: SAVE:GALACTIC TRIUMPH,D2 (return).

*****DISK[:<comment>]**

The ***DISK command increases the karma of the user when using DOS 3.1. This command has no effect when using DOS 3.2 or a cassette based system. Sample command: ***DISK: FILE NOT FOUND ERROR (return).

TYPE 2 COMMANDS

These commands are done immediately. They do not cause an item to be written at the current cursor location, as Type 3 and Type 4 Commands do, but they do affect the current song data.

DEL

The DEL symbol is used to delete the item the cursor is currently at. It is requested by pressing Paddle 0's button while the upward-pointing arrow is aimed at DEL. When requested, the item the cursor is at is deleted from the song data. If it is a note, it is sounded through the synthesizer if the speaker/arrow block is lit (see the speaker/arrow Type 1 Command). The end marker of a part or subroutine cannot be deleted. If this is attempted, the Apple speaker beeps.

DELETE:<1-255>

The DELETE command is used to remove one or more items from the current part

or subroutine. It is the same as one or more DEL symbol requests (above) except the notes are never sounded and there is no "beep" when an attempt is made to delete the end marker. The number of DEL's is selected by the <1-255> parameter. More than 255 items can be deleted only using more than one DELETE command. Sample command: DELETE:73 (return).

EDIT

The EDIT command is used to increase the number of parts, change the suggested speed, and/or change any or all of the 4 title lines. Once entered, the command proceeds to ask for the new NUMBER OF PARTS?, SUGGESTED SPEED?, and TITLE LINE 1 through TITLE LINE 4. If there is no change desired on any item, just press return. Otherwise, enter the new value and press return. For each TITLE LINE, the current line is displayed and can then be edited using the left and right arrow keys on the Apple keyboard. Note that when return is pressed for a title line, all characters to the right of the flashing cursor, and the character under the flashing cursor unless it is the 40th character, are set to space. The SUGGESTED SPEED must be from 0 to 255. (1 through 255 select paddle speeds, and 0 activates Timing Mode.) The NUMBER OF PARTS? must be greater than or equal to the current number of parts, but less than 10. (Remember you can only play 3 parts per synthesizer, and 1 less part when using Timing Mode.) If the number of parts is increased, the stereo settings are set to standard settings (see NEW, a Type 2 Command; and STEREO, a Type 2 Command). See SUBROUTINE (a Type 2 Command) for details on reduction of "notes free" when increasing the number of parts. The cursor is set to the first item in Part 0. Sample command: EDIT (return).

LOAD[:<song name>][<disk specifications>]

The LOAD command is used to load a song from cassette tape (or whatever is connected to the Apple's cassette in jack) or disk. The song currently in memory is lost. These commands are used the same as the LOAD commands in BASIC. See SAVE (a Type 1 Command) for additional comments. The cursor is set to the first item in Part 0. Sample command: LOAD:GALACTIC TRIUMPH (return).

NEW

The NEW command is used to start fresh. Once entered, the NEW command asks for the NUMBER OF PARTS? which should generally be entered as 1. If return is pressed, 1 is assumed. The number of parts cannot exceed 9. Remember that parts created cannot be destroyed and that song playback ends when the end of the highest numbered part is reached. New parts (created either with NEW or with EDIT, a Type 2 Command) contain KEY:C, TIME:4/4, QUARTER:240, GAP:65535, TRANSPOSE:0, ATTACK:8192, DECAY:50, VOLUME:55000, SUSTAIN:0, and RELEASE:50. (All subroutines and parts always end with an end marker.) Stereo is set to the standard values: STEREO:2,LRLRLR and STEREO:3,MLRMLRMLR. The NEW command then

asks for the SUGGESTED SPEED? which can be given as any integer from 0 to 255, or just press return for 255. Finally, the NEW command asks for the 4 TITLE LINES. These are initially set to all spaces. The cursor is set to the first item in Part 0. Sample command: NEW (return).

SPEED:<1-65535>[/<1-65535>]

The SPEED command is used to change the duration of all notes, rests, and QUARTER functions in all parts and subroutines. The colon after SPEED is followed by an integer from 1 to 65535 to multiply all time durations by. This is optionally followed by a slash (/) and another integer from 1 to 65535 indicating a number to divide by. (If not specified, this is assumed to be 1.) All time durations are multiplied by the first integer, then divided by the second integer. Any "remainder" (or non-integral portion) is ignored, and the result MOD 65536 is used. For example, a note length of 240 divided by 50 (using SPEED:1/50) would become 4 since 240/50 equals 4.8. The .8 time periods dropped will eventually accumulate (differently in different parts) and create unusual timing. Therefore, such non-integral results should usually be avoided. Any 0 results are changed to 1. **CAUTION:** extreme care must be taken to avoid destruction of the song! Saving the song prior to attempting a SPEED command is strongly recommended. Sample command: SAVE:GALACTIC TRIUMPH (return) SPEED:1/2 (return).

STEREO:<2-3>,<string>

The STEREO command is used to change the stereo selection programmed in the song. Although stereo outputs are available only when using two or three synthesizers, you may wish to set the stereo selection even when using only one unit if the song may be played by others having more units. STEREO:2,<string> sets the stereo which will be used when the song is played back on a system with 2 synthesizers. It applies only to songs having 6 or fewer parts. The <string> must consist of L's (for Left) and R's (for Right). There should be one letter for each part. The first letter specifies the position for Part 0, the second for Part 1, etc. There cannot be more than 3 L's or more than 3 R's. Note that songs should usually not have more than 2 R's. If a song has 3 R's, it cannot be played on a system with Timing Mode unless 3 synthesizers are used. STEREO:3,<string> sets the stereo which will be used when the song is played back on a system with 3 synthesizers. It is used the same as the STEREO:2,<string> command except that in addition to L's and R's, M's can be used (for Middle). There cannot be more than 3 M's, and no more than 2 M's can be used if Timing Mode is to be used during playback. When creating a song for general use, STEREO:3,<string> should always be specified. STEREO:2,<string> should also be specified on all songs having 6 or fewer parts. **NOTE:** the EDIT command changes both the STEREO:2,<string> and STEREO:3,<string> settings if the number of parts is increased. The stereo settings selected are programmed into

the CHANNEL function (see the PERFORM section) and thus will be saved with the song. Sample command: STEREO:2,LLR (return).

SUBROUTINE:<Ø-99>

The SUBROUTINE command is used to create a subroutine, or to view (and thus ready for editing) an existing subroutine. (Note: this command may be considered a Type 1 Command if used to access an existing subroutine rather than create a new one.) The creation of a new subroutine will reduce the number of free notes by the following amounts depending on the number of parts: 2 for 1 part, 3 for 2, 4 for 3 or 4, 5 for 5, 6 for 6 or 7, 7 for 8, and 8 notes for 9 parts. (NOTE: increasing the number of parts with EDIT, a Type 2 Command, reduces the number of free notes by enough to account for the difference in storage requirements for each subroutine (since more "notes" of storage are required per subroutine when more parts are present, as shown above), plus 12 and 2/3rds notes per new part.) The cursor is positioned to the first item in the selected subroutine, or the end marker in that subroutine if there are no items. **CAUTION:** subroutines are assigned numbers from Ø up (by ones) when a song is loaded and when RESET is pressed (CØØG must be typed on systems without an Auto-Start ROM). The numerical order of the subroutines does not change. Sample command: SUBROUTINE:83 (return).

TYPE 3 COMMANDS

These commands are not done immediately, but rather are stored in the song data at the current cursor position. The item currently at the cursor position is erased unless insert mode is on. These commands do not affect playback. They affect only newly entered notes and rests, or the screen display. Commands of this type included within a subroutine affect only the display and entry of notes within the subroutine itself, and not within any part (or other subroutine) calling the subroutine. The number of notes free goes down by 1 for each inserted command, but stays the same for replaced commands.

KEY:<1-6><S-F> or KEY:C

The KEY command is used to change the key signature. (If no KEY command has occurred in the part or subroutine so far, the key is assumed to be KEY:C.) KEY:C specifies no sharps or flats, and an integer from 1 to 6 followed by an S or an F specifies the indicated number of sharps (S) or flats (F). All notes entered so as to appear in the song data after this KEY command (but before the next KEY command) will be affected by this KEY command. Any note not entered as "sharp", "flat", or "natural" will be changed to sharp if it is one of the notes indicated as sharp in the key signature, or changed to flat if it is one of the notes indicated as flat in the key signature. Notes not indicated as either sharp or flat by the key signature are left as is. Sample command: KEY:3S (return).

QUARTER:<1-65535>

The QUARTER command is used to change the duration of notes entered except when using non-standard durations with LENGTH (a Type 1 Command). All notes entered so as to appear in the song data after this QUARTER command but before the next QUARTER command will be affected. (If no QUARTER command has occurred in the part or subroutine so far, it is assumed to be QUARTER:24Ø.) See the PADDLE Ø and PADDLE 1 Type 4 Commands for additional details. Sample command: QUARTER:48Ø (return).

TIME:<1-19>/<note>

The TIME command is used to change the time signature. (If no TIME command has occurred in the part or subroutine so far, the meter is assumed to be 4/4.) The colon after TIME is followed by the number of notes (of a certain duration) to occur per measure. This is followed by a slash (/) which does not mean division (this is a special case). The slash is followed by an integer which specifies the note duration referenced by the other integer. It must be 1 for a whole note, 2 for a half, 4 for a quarter, 8 for an eighth, or 16 for a sixteenth note. The number of time periods allowed per measure will be the current QUARTER setting times 4 times the number before the slash, all divided by the number after the slash. This command determines the positioning of measure bars, which in turn affects whether a note is sharp (or flat) or not (see the PADDLE 1 Type 4 Command). It affects all notes entered so as to appear in the song data after this TIME command but before the next TIME command. Sample command: TIME:2/2 (return).

TYPE 4 COMMANDS

These commands are not done immediately, but rather are stored in the song data at the current cursor position. The item currently at the cursor position is erased unless insert mode is on. These commands are executed during playback. They are executed during a subroutine call and thus may effect notes entered in a given part (or subroutine) after a call to the subroutine containing these commands. The number of notes remaining goes down by 1 for each inserted command, and stays the same for replaced commands, except as noted for TIE. <value> always refers to an integer from Ø to 65535, optionally followed by a slash (/) and another integer from Ø to 65535. When the slash is specified, the indicated division is done and the resultant value (ignoring any remainder or non-integral portion) is used as the parameter.

REST

The REST symbol is requested by pressing Paddle Ø's button while the upward-pointing arrow is pointing at REST. When requested, a rest is written in the

song data. The duration of the rest is determined in the same fashion as the PADDLE 1 Type 4 Command (below).

PADDLE 1

Note entry is accomplished by pressing Paddle 1's button. The vertical position of the note cursor (controlled by Paddle 1's knob) determines the pitch of the note, subject to various sharps and flats, and (during playback only) the current TRANSPOSE (Type 4 Command) setting. Notes will be natural, sharp, or flat; as indicated by a block under one of these in the menu, and the blocks cleared, if one of these blocks is lit. Otherwise, notes are entered as natural unless they must be sharp or flat due to the current key signature or due to a prior note in the measure of the same pitch being sharp or flat. (Note: all octaves are affected by the key signature, but not by prior sharp or flat notes in the measure.) Natural, sharp, or flat signs are displayed on the screen only when necessary. Duration is as specified by LENGTH (a Type 1 Command) unless one or more blocks are lit under the seven notes in the menu. (Note: "." and "3" do affect LENGTH settings.) If a block is lit, the length will be assumed to be as specified by the most recent QUARTER command for quarter notes, and proportional values for all other notes. A block under "." multiplies the length by 3/2, and a block under "3" multiplies the length by 2/3. (A block under both multiplies the length by 2/3 and then by 3/2.) Entry of a sixty-fourth note (selected by a block under the sixty-fourth note) is not allowed if the "." block is lit. (Dotted sixty-fourth notes are never displayed.)

TIE

The TIE symbol is requested by pressing Paddle 0's button while the upward-pointing arrow is pointing at TIE. When requested, the duration which would be used if a note were entered (see the PADDLE 1 Type 4 Command) is added to the duration of the note or rest the cursor is currently at. (If the cursor is not at a note or rest, the Apple speaker beeps and the cursor moves left one item.) This command is unaffected by insert mode, and it never changes the number of notes free.

ATTACK:<value>

The ATTACK command changes the current attack setting. The value specified is the maximum amount the "current loudness" can increase in any given "time period". Sample command: ATTACK:55000/30 (return).

CALL:<0-99>

The CALL command is used to have the Type 4 Commands in the specified subroutine be executed during playback. The integer (from 0 to 99) specifies which subroutine should be done. More than one part may call the same subroutine (or different subroutines) at the same time. A subroutine may call itself provided at least one time period of duration occurs within the subroutine

prior to the call to itself. A CALL cannot be entered until after its subroutine has been created. See SUBROUTINE (a Type 2 Command) for additional information. Sample command: CALL:83 (return).

DECAY:<value>

The DECAY command changes the current "decay setting". The value specified is the maximum amount the "current loudness" can decrease in any given "time period" unless the RELEASE rate is currently being used. Sample command: DECAY:100 (return).

GAP:<value>

The GAP command changes the current gap setting. When the time remaining for any note equals the current gap setting, the release stage of the envelope begins. Sample command: GAP:60 (return).

POKE:<0-255>,<0-255>,<0-255>

The POKE command is used to enter non-standard commands. **CAUTION:** use of this command renders this documentation meaningless and may well scramble memory during playback. Integers from 0 to 191 followed by 0 and 0 (for example, POKE:78,0,0) enter notes of zero duration, the correct duration can be TIEd in. For information on other values, see the PERFORM section, and the SONG DATA FORMAT heading in this section. Sample command: POKE:0,240,0 (return).

RELEASE:<value>

The RELEASE command changes the current release setting. The value specified is the maximum amount the "current loudness" can decrease in any given "time period" unless the DECAY rate is currently being used. Sample command: RELEASE:100 (return).

SUSTAIN:<value>

The SUSTAIN command changes the current "sustain setting". The value specified is the "desired loudness" which the "current loudness" follows, unless the desired loudness is currently 0 for a release stage or the current volume setting for an attack stage. Sample command: SUSTAIN:45000 (return).

TEMPO:<value>

The TEMPO command is used to change the playback tempo. It need appear in only one part since it affects the playback speed (tempo) of all parts. Although it should be included in any song for general use, it is active only when using Timing Mode (see the TIMING MODE section). The TEMPO setting should be about $19.25 * (\text{paddle setting} + 1)$. There will be $1782000 / \text{TEMPO}$ time periods per second, unless the selected time period is too short for all necessary computations to occur. Sample command: TEMPO:4735 (return).

TRANPOSE:<0-255>

The TRANPOSE command is used to change the current transpose setting. Values from 0 to 127 raise all following pitches (until the next TRANPOSE command) by 0 to 127 quarter steps; values from 255 to 128 lower all following pitches by 1 to 128 quarter steps. 24 quarter steps equals 1 octave. Sample command: TRANPOSE:232 (return).

VOLUME:<value>

The VOLUME command changes the current volume setting. The value specified is the "desired loudness" which the "current loudness" follows unless the envelope is not currently in an attack stage. Sample command: VOLUME:50000 (return).

TIPS

PARTIAL STARTING MEASURE

Often songs begin with a measure which is short, perhaps containing only a single note. If such a song were entered in the normal fashion, the measure bars would not appear at the correct places. There are many ways of solving this problem. The simplest and perhaps best way is to start by entering a rest which is long enough to fill one measure when the partial (starting) measure is entered after the rest. Not only does this put the measure bars in the right places, it also causes a brief delay before song playback begins during a PLAY command, which may be considered desirable. Another method is to put the partial measure in a subroutine, and call it. (The duration of notes within a subroutine is not added to a part which contains a CALL to that subroutine.) Yet another method is to enter the partial measure, and then enter a TIME or a QUARTER command to start the measure over.

RESTS AT THE END OF PARTS

Each part should end with a rest. It can be as short as you like, and it serves to begin the release stage of the envelope. Otherwise a release stage may begin unexpectedly (when the constantly cycling time remaining equals the current GAP size). Additionally, the highest numbered part should end with a rest long enough to let all parts decay (or release, actually) down to zero volume, and perhaps even show a "blank" screen for a second. PERFORM users may find this particularly necessary, lest the parts continue playing after PERFORM returns to the calling program.

PADDLE SETTINGS

Paddle settings which are too small will create "time periods" which are not long enough for all necessary calculations. When this happens, the "time period" is lengthened so that all calculations are completed. Since the calculation time required varies, the song playback speed will vary too. There is no time period variation when the paddle setting is high enough. Generally, paddle settings lower than 150 are never used. Songs having many parts active and using several levels of subroutines may require even higher settings. The number of time periods in one second is approximately $93000/(\text{paddle setting}+1)$.

"BACK-UP"

While entering particularly long songs, it is a good idea to save the song periodically in case the power fails, ENTRY hits an undiscovered bug, or you accidentally delete half the melody.

TRANPOSE

Each part must contain a TRANPOSE before the first note, even if it is a TRANPOSE:Ø.

COPYING SONGS WITHOUT ENTRY

Systems equipped with Integer BASIC can copy songs from one tape or disk to another without running ENTRY. Just load the song as if it really were an Integer BASIC program, and save it. Since it isn't a BASIC program, attempting to change or delete a line, or attempting to RUN it, would probably scramble the song data; however, a load followed immediately by a save will work properly.

RESET

On systems without an Auto-Start ROM, CØØG (return) must be typed if RESET is pressed. That's C zero zero G, not COOG. RESET can safely be used during a PLAY command. RESET must not be used during the execution of any other command, or the song data may be destroyed.

INTEGER/APPLESOFT SWITCH

On systems with a ROM card (for Applesoft or Integer BASIC), the switch must be set for a start-up language which matches the version of ENTRY being used.

SONG DATA FORMAT

Song data is stored as described in the PERFORM section with the following changes:

1. Song data always begins in memory at 5000 hex.
2. The END command (FF 00 00) is followed by a byte giving the suggested speed, then 160 bytes which form the four title lines.
3. The QUARTER command is stored with command type FB hex.
4. The KEY command is stored with command type FC hex. A parameter of zero indicates C. Otherwise, the number of sharps/flats is stored with the most significant bit being 0 for flat or 1 for sharp. The third byte is not used.
5. The TIME command is stored with command type FD hex. The second byte indicates the number of notes per measure, and the third byte the type of note.
6. All TRANSPOSE commands have a third byte of FE. This allows the least significant bit of each note to indicate sharp or flat.
7. When loaded using Integer BASIC, locations CA and CB hex ("PP") indicate the starting address of the data. Locations 4C and 4D hex ("HIMEM") indicate the address past the last byte of data.

SELECTED HEX ADDRESSES

4C & 4D: defines the address of the first byte of unavailable memory

72: defines the lowest slot number times 16

87: defines the number of synthesizer units

5E & 5F: defines the address of the first byte following the song's title lines (end of song pointer)

5000: start of song data

A76: start of pitch divisor table

4F38: start of Entry-generated subroutine address table

4D52-4D75: part initialization data

4ECD-4F36: command table expansion area

4DAA-4DB2: standard stereo positions

Base page usage: (see also PERFORM base page usage)

0-19	26-27	36-39	3C-3F	4A-4D	50-55	58-8F	CA-CD
------	-------	-------	-------	-------	-------	-------	-------

TRANPOSE

Each part must contain a TRANPOSE before the first note, even if it is a TRANPOSE:Ø.

COPYING SONGS WITHOUT ENTRY

Systems equipped with Integer BASIC can copy songs from one tape or disk to another without running ENTRY. Just load the song as if it really were an Integer BASIC program, and save it. Since it isn't a BASIC program, attempting to change or delete a line, or attempting to RUN it, would probably scramble the song data; however, a load followed immediately by a save will work properly.

RESET

On systems without an Auto-Start ROM, CØØG (return) must be typed if RESET is pressed. That's C zero zero G, not COOG. RESET can safely be used during a PLAY command. RESET must not be used during the execution of any other command, or the song data may be destroyed.

INTEGER/APPLESOFT SWITCH

On systems with a ROM card (for Applesoft or Integer BASIC), the switch must be set for a start-up language which matches the version of ENTRY being used.

SONG DATA FORMAT

Song data is stored as described in the PERFORM section with the following changes:

1. Song data always begins in memory at 5000 hex.
2. The END command (FF 00 00) is followed by a byte giving the suggested speed, then 160 bytes which form the four title lines.
3. The QUARTER command is stored with command type FB hex.
4. The KEY command is stored with command type FC hex. A parameter of zero indicates C. Otherwise, the number of sharps/flats is stored with the most significant bit being 0 for flat or 1 for sharp. The third byte is not used.
5. The TIME command is stored with command type FD hex. The second byte indicates the number of notes per measure, and the third byte the type of note.
6. All TRANSPOSE commands have a third byte of FE. This allows the least significant bit of each note to indicate sharp or flat.
7. When loaded using Integer BASIC, locations CA and CB hex ("PP") indicate the starting address of the data. Locations 4C and 4D hex ("HIMEM") indicate the address past the last byte of data.

SELECTED HEX ADDRESSES

4C & 4D: defines the address of the first byte of unavailable memory

72: defines the lowest slot number times 16

87: defines the number of synthesizer units

5E & 5F: defines the address of the first byte following the song's title lines (end of song pointer)

5000: start of song data

A76: start of pitch divisor table

4F38: start of Entry-generated subroutine address table

4D52-4D75: part initialization data

4ECD-4F36: command table expansion area

4DAA-4DB2: standard stereo positions

Base page usage: (see also PERFORM base page usage)

0-19	26-27	36-39	3C-3F	4A-4D	50-55	58-8F	CA-CD
------	-------	-------	-------	-------	-------	-------	-------

4

PLAY

The PLAY program is used to play songs entered with ENTRY. Songs can be read from cassette tape or from disk. Although songs cannot be edited with PLAY, it has several advantages over ENTRY. PLAY's main advantage is that it requires less memory than ENTRY. This means that PLAY can be loaded (from tape or disk) faster than ENTRY, and it allows playback of songs which are too large to load with ENTRY. Another important feature of PLAY is that most disk commands can be used (ENTRY allows only LOAD and SAVE). This allows "Exec Files" to be used, either as created by the DISCO program or custom files.

To run PLAY, you must have 5K bytes of memory plus enough additional memory to hold the song. If you are using a DISK II, you need 15.5K plus the song length. (Using the Applesoft version, these figures are 8K and 18.5K.) The maximum song length is 28K. (17.5K for songs entered using a DISK II system with MAXFILES 3.)

First, load the program from disk or cassette tape. List line 10. It will be 10 SLOT=4 : UNITS=1. Find the proper SLOT and UNITS values for your system using the table in the INSTALLATION section. Carefully retype the line changing only the digits 4 and 1 to the proper digits for your system. (If you have a Timing Mode Input Board, list line 20. It will be 20 T SLOT=8. Carefully retype the line changing only the digit 8 to the slot number of your Input Board). Now save the program on your disk. If you do not have a DISK II, save the program using your own recorder to improve loadability. The program is now configured for your system, and can be run any time you like without having to change line 10 (or 20). If you ever change the slot position of your synthesizer(s) (or Input Board), or purchase an additional synthesizer or an Input Board, you should do this configuration procedure again.

When run, PLAY will print a period (.) as a prompt character. The following commands can then be used:

LOAD[:<song name>[<disk specifications>]]

This command is the same as the load command in ENTRY (see the ENTRY section, SUMMARY OF COMMANDS).

PLAY[:<song name>[<disk specifications>]]

This command is a mixture of the play command in ENTRY (see the ENTRY section, SUMMARY OF COMMANDS) and the load command (above). Typing PLAY (return) is used to play the song currently in memory (you must have already loaded a song, of course). PLAY:<song name>[<disk specifications>] is used to load a song and then play it.

STOP

This command is used only in ALBUM files created by DISCO (see the DISCO

section). It goes to BASIC, leaving the PLAY program in memory for continuation with RUN. Either RUN or INT (FP when using Applesoft) should always be used after a STOP command.

INT or FP

INT (or FP for Applesoft) is used to stop using PLAY. The PLAY program is erased and must be reloaded if you desire to run it again.

Most disk commands, such as CATALOG and EXEC, can be used while running PLAY.

ENTRY's PLAY:F is not available in PLAY since the F would be assumed to be a song name.

If you wish to stop playback, press RESET. On systems not equipped with an Auto-Start ROM, type 3DØG (control C return on cassette systems) to return to BASIC. Once in BASIC, type RUN to clear the synthesizer and continue using PLAY.

5

DISCO

The DISCO program is used to create an "Exec File" which can be used to play songs in succession. It can also randomize the playback order. It can be used only on systems equipped with a DISK II. A text file named ALBUM is created, so a disk which is not write-protected is required. The procedure is as follows:

Load DISCO from cassette tape or disk, and save it on your disk. (If you have already done this, just LOAD the program from your disk.) Type RUN 1000 and press return. DISCO will print a brief set of instructions.

It is best if you have a printed catalog listing for this next step. If you don't have one, just type CATALOG occasionally to see the catalog listing. Type in the song names to be played, pressing return after each song name. Do not type the "M:" (for example, if you used SAVE:GALACTIC TRIUMPH from ENTRY, then you should type GALACTIC TRIUMPH (return) for DISCO, rather than M:GALACTIC TRIUMPH which is how the song will appear in the catalog). If you wish to have the songs played in a particular order, you must type them into DISCO in that order.

When all songs have been entered, type STOP and press return. **CAUTION:** care must be taken to not hold down the keyboard keys while typing STOP. The lack of n-key rollover on the Apple keyboard will cause unseen control letters to be entered if several keys are held down at once. This would cause a song title to be entered which consists of STOP and these control letters, rather than a STOP command.

If you wish to always use the same playback order, type LOCK ALBUM and press return. It will be necessary to type UNLOCK ALBUM if you ever wish to delete the ALBUM file or make any changes to it.

To play the whole sequence (or "album") of songs, you type EXEC ALBUM and press return. If you wish to have the order randomized, type RUN DISCO (or, if DISCO is already loaded, type RUN). To do either of these, a properly configured PLAY program must be on the disk and named PLAY. When album playback is complete, you can type RUN to run PLAY or EXEC ALBUM to hear the songs again. Otherwise, type INT or FP to stop using PLAY.

TO ADD SONGS

Load the DISCO program, and type RUN 2000 (return). After the instructions are printed, proceed in the same fashion as when originally creating the album (done with RUN 1000, above).

TO START OVER

If you wish to scratch the old ALBUM file and make a new one, type DELETE ALBUM (return). Then LOAD DISCO and RUN 1000 as described above. If you do not DELETE

ALBUM, and if the new ALBUM file is shorter than the old one, commands remaining at the end of the file will result in errors after album playback is completed.

USING "START" and "END"

When randomizing the song order using RUN DISCO, you can have one particular song played as the first song, and/or another played as the last. These songs must be named START (for the first song) or END (for the last song). When a song named END is entered (during RUN 1000 or RUN 2000), DISCO stops (there is no need to use a STOP command). END will remain the last song even if more songs are added (using RUN 2000) or the order is randomized (using RUN). The song must appear in the catalog as M:END. The START song should generally be entered as the first song, when the album is first made using RUN 1000. Otherwise it will not be the first song until it is randomly placed as the first (but will remain first from then on). It must appear in the catalog as M:START.

USING MORE THAN ONE DISK DRIVE

Songs in an album can occupy more than one disk drive. The ALBUM file and the PLAY program must be on the same disk (as must be the START song, if used). (The END song, if used, must be on all disks.) Songs must be entered (when using RUN 1000 or RUN 2000) followed by the proper disk specification. For example, when using two drives on the same controller, all songs on drive 1 must be followed by ",D1" and all songs on drive 2 must be followed by ",D2" (note: START and END must not be followed by a disk specification). If you are not using the randomization feature, the disk specifications need only be given when there is a change (for example, when the previous song was on drive 1 but this song is on drive 2, it must be followed by ",D2"). Be sure to leave enough room on the disk containing the ALBUM file for possible expansion of the file. **NOTE:** song titles are limited to 28 letters, including the disk specifications.

6

PROGRAMMING

WITH PERFORM

The PERFORM program is used to play songs from your own programs. It can play songs entered with ENTRY, or songs created by other means (see the SONG DATA description in this section).

PERFORM is rather difficult to use on systems which do not have a DISK II. In this case, PERFORM must be loaded from tape and RUN. PERFORM will then be located at 802 hex (2050 decimal) in memory. LOMEM is automatically changed so PERFORM will not be erased by other programs you may load (note: be sure to avoid using control B or programs which change LOMEM). To use PERFORM, you must have a song in memory. At 800 hex (2048 decimal) you must put the starting address of the song MOD 256. (In Applesoft, this is address-INT(address/256)*256 since MOD is not available.) At 801 hex (2049 decimal) you must put the starting address of the song divided by 256. (In Applesoft, this is INT(address/256).) Then, a CALL to 802 hex (2050 decimal) causes the song to be played. The remainder of this section assumes you have a DISK II, but only the loading methods are different when using a cassette system (and the proper loading method has just been described). All explanations regarding the song data format are the same for any system. (**Note:** when using Applesoft, the word LOMEM in this paragraph refers to the start-of-program pointer.)

When using a system with a DISK II, you should change the PERFORM program into a binary file. Since you will probably want to still use the name PERFORM, you will have to delete the original PERFORM program since two programs cannot have the same name. To be on the safe side, you should begin by saving the original PERFORM program on some disk for possible future use. (Be sure you just LOAD PERFORM and then SAVE PERFORM on another disk. Do not RUN it or it will not be properly saved.) To begin, type INT (FP on Applesoft systems). Now load the PERFORM program (from cassette tape or disk). If you loaded it from disk, and wish to have the binary version of PERFORM on the same disk, you must DELETE PERFORM. Now RUN the program. Then type BSAVE PERFORM,A2050,L676 and press return. A binary file version of PERFORM will be saved on the disk. To finish, type INT (FP on Applesoft systems).

To copy the binary version of PERFORM to another disk, type BLOAD PERFORM,A2050 to load it, and then BSAVE PERFORM,A2050,L676 to save it on the desired disk.

If you wish to play an ENTRY-created song from your own BASIC program, it will first be necessary to convert the song into a binary file so your program can load it. In order to play a song, its data must be initialized to have the correct SLOT and UNITS settings for your system. The easiest way to do this is to run a properly configured ENTRY program (see the ENTRY section), load the song and play it, then save the song back on disk. ENTRY's PLAY command will configure the song. (Note: you must remember to SAVE the configured song back

on disk, or the disk copy of the song will not be configured.) Once you have done this, you are ready to convert the song into a binary file. (Note that it will be necessary to reconfigure the song if you change the slot location(s) of your synthesizers or add another synthesizer.) The following Integer BASIC program converts songs into binary files. Type it in and save it. Note that "d" means to type control D.

```
10 POKE 76,0 : POKE 77,124 : DIM A$(40) : INPUT "SONG NAME?",A$
20 PRINT "dLOADM:";A$ : A=PEEK(202)+PEEK(203)*256
30 PRINT "dBSAVE";A$;"A";A;"L";31744-A : PRINT "LENGTH: ";31744-A
40 PRINT "dINT"
```

Note: this program requires 48K. On 32K systems, change the 124 to an 80 and the two 31744's to 20480's. Songs entered on a 48K system with MAXFILES less than 3 (or on a cassette based system) may be too large to convert on a 32K system.

If you do not have Integer BASIC, use the following Applesoft version instead. Type it in and save it. Note that "d" means to type control D.

```
10 POKE 76,PEEK(115) : POKE 77,PEEK(116) : POKE 217,0
20 HIMEM:30000 : INPUT "SONG NAME?";A$
30 POKE PEEK(54)+PEEK(55)*256+3065,0
40 PRINT "dLOADM:";A$ : A=PEEK(202)+PEEK(203)*256
50 L=PEEK(76)+PEEK(77)*256-A : PRINT "dBSAVE";A$;"A";A;"L";L
60 PRINT "LENGTH: ";L : PRINT "dFP"
```

To use either program, begin by typing INT (FP for the Applesoft version). Then RUN the program. It will ask for a song name. Type in the name of the song to be converted (without the M:) and press return. The song will be converted and saved on your disk as a binary file with the same name as the song but without the M:. The conversion program also prints the length of the song in bytes. Although this length can be determined simply by BLOADing the song and looking at the DOS 3.2 file length locations (see your DOS manual), you may wish to write the length down since you will probably need to know it. To convert another song, follow the instructions above again. You can omit the initial INT (or FP), but you must load the program again to run it (or use RUN name) since the program self-destructs each time it is used.

AN EXAMPLE

Let's say you want to try this procedure with the sample song MUSETTE. First, store a binary version of PERFORM as described above, and save the conversion program given above. Let's assume you named the conversion program CONVERT.

Now, RUN ENTRY. (This assumes you have already configured ENTRY for your system configuration as described in the ENTRY section.) LOAD:MUSETTE, PLAY, and SAVE:MUSETTE. Now type INT to exit ENTRY. You are now ready to convert the song. Type INT (or FP). Type RUN CONVERT. It will ask for a song name. Type MUSETTE and press return. The song will be converted and saved on your disk as MUSETTE, and the length will be printed. (If you had another song to convert now, you would start with RUN CONVERT.) Now, the song can be played with PERFORM. To do this, begin with BLOAD PERFORM. Now type BLOAD MUSETTE,A2960 and then POKE 2048,144 and POKE 2049,11. Type CALL 2050 to play the song. Note that paddle 0 controls the playback speed. When playback is finished, you could play the song again just by typing CALL 2050.

What are the mystic pokes for? Locations 2048 and 2049 must be set to the starting memory address of the song data. We loaded the song at 2960. Note that $11*256+144$ (11 and 144 being the numbers we poked) is 2960, the starting address. 2960 just happens to be the first byte of memory available after PERFORM, which uses locations 2048 through 2959.

With a few precautions, you could have had a BASIC program do the BLOADs, POKEs, and CALL. The only other detail is that in this example we used ENTRY to initialize the synthesizers (when MUSETTE was configured), and for general purpose BASIC programs you would probably want to have your program initialize the synthesizers. If you were writing a program to be used on other people's computers, you would probably want to have your program configure the song data, too.

A FEW PRECAUTIONS

When using PERFORM from a BASIC program, you will have to find a place to put the song data. You will also have to keep BASIC from erasing PERFORM.

WITH INTEGER BASIC

When using Integer BASIC, the easiest place to put the song data is right after PERFORM. (Starting at 2960 decimal.) LOMEM can be moved up to keep BASIC from erasing either PERFORM or the song data. First, figure out where the song data will end. You will need to know the length of the longest song you plan to BLOAD, or the sum of the lengths of the longest songs you plan to have in memory at the same time. Take this length and add the starting address (2960). This is what LOMEM must be. You can either set LOMEM using a LOMEM command, or you can have your program set LOMEM. It is probably best to have your program do it so you won't forget, and so others can use it. The LOMEM command also changes a value Apple calls CM, so your program must change it too. To do all this, find out what $LOMEM \text{ MOD } 256$ and $LOMEM/256$ are (for the new LOMEM, of

course). For example, if your longest song is less than 2048 bytes, LOMEM could be $2960+2048$ which is 5008. $5008 \text{ MOD } 256$ is 144 and $5008/256$ is 19. To have your program change LOMEM and CM to these values, make the first statements `POKE 74,144 : POKE 204,144 : POKE 75,19 : POKE 205,19`. These four pokes must be the first statements in your program, or at least be before any variables are used. After these, you can BLOAD PERFORM by using `PRINT "dBLOAD PERFORM"` where the "d" is a control D. You can load a song using `PRINT "dBLOAD song name,A2960"` where "song name" is the name of the song to be loaded. If you wish to load a second song, change the 2960 after the A to a value which is 2960 plus the length of the first song or greater. Similarly, a third song can be loaded with an A value of 2960 plus the combined lengths of all previously loaded songs (or greater). Loading several songs lets you do a lot of disk reading at the beginning of the program (or any time before playback is needed) and then play any of the loaded songs at any time without delay. On the other hand, you may wish to just load a song, play it, then load another song and play it. This requires less memory, and it splits up the disk reading time. (When reading one song at a time, you only need enough memory to hold the longest song, and you BLOAD each song at the same address.) To play any song, you will need its starting address. This is the number after the A in the BLOAD command. The address MOD 256 must be poked at 2048, and the address/256 must be poked at 2049. Then a `CALL 2050` is used to play the song. If you load another song at the same address, you don't need to poke the starting address again. However, if you've loaded several songs, you will need to poke the starting address of the desired song before using `CALL 2050` to play it.

You can, of course, locate your song data any place it won't be erased. You must still move LOMEM up to at least 2960 to keep Integer BASIC from erasing PERFORM.

WITH APPLESOFT BASIC

Applesoft's memory organization is very crude, and thus more awkward preparations (than with Integer BASIC) are required. To begin with, your program should start with several REM statements. They should be line numbers 1 through 4. Line 1 should be typed in as `1REMXXXX...` with no spaces and with enough X's to completely fill 6 lines on the Apple's 40 column display. (There will be 235 X's. Don't type the ... of course.) Lines 2 through 4 must start as `2REMXXXX...` `3REMXXXX...` etc. These REM statements provide enough room for the PERFORM program. The next lines in your program should change Applesoft's start-of-program pointer to eliminate the REM's (while keeping enough room available for PERFORM). This is done with the statements `POKE 103,197 : POKE 104,11`. This is all you need to keep Applesoft from erasing PERFORM. Now an area of memory for the song(s) to be played is needed. The easiest area to use is the memory below the DOS system (below HIMEM). You will need to know the length of the longest song you plan to BLOAD, or the sum of the lengths of the longest songs you plan

to have in memory at the same time. Let's call this number "length". Before your program uses any variables, you should have this statement to reserve an area of memory (of length "length") for the song(s): `IF PEEK(2050)<>138 THEN HIMEM:PEEK(115)+PEEK(116)*256-length`. After this, you can use `PRINT "dBLOAD PERFORM"` to read in the PERFORM program (remember that "d" means to type control D). Now you should set a variable which indicates the address of this memory area. This is done with the statement `A=PEEK(115)+PEEK(116)*256`. You can load a song using `PRINT "dBLOAD song name,A";A` where "song name" is the name of the song to be loaded. If you wish to load a second song, use `PRINT "dBLOAD song name,A";A+L` where "song name" is the name of the second song, and L is the length of the first song. Similarly, a third song can be loaded using a value for L which is the combined lengths of all previously loaded songs. Loading several songs lets you do a lot of disk reading at the beginning of the program (or any time before playback is needed) and then play any of the loaded songs at any time without delay. On the other hand, you may wish to just load a song, play it, then load another song and play it. This requires less memory, and it splits up the disk reading time. (When reading one song at a time, you only need enough memory to hold the longest song, and you BLOAD each song at the same address.) To play any song, you will need to poke its starting address at 2048 and 2049. The starting address is the value A (or A+L) in the BLOAD command. Use `POKE 2048,A-INT(A/256)*256 : POKE 2049,A/256`. Then a `CALL 2050` is used to play the song. If you load another song at the same address, you don't need to poke the starting address again. However, if you've loaded several songs, you will need to poke the starting address of the desired song before using `CALL 2050` to play it.

You can, of course, locate your song data any place it won't be erased. You must still use the REM statements and the `POKE 103,197 : POKE 104,11` to keep Applesoft from erasing PERFORM.

CAUTION: when you run your Applesoft program, the REM statements will disappear. This will present no problems unless you save the program while the REM statements are gone. If you do, then sometime later (when PERFORM is no longer in memory) you may run the program and the first few lines would disappear, possibly causing bizarre listings (due to partial lines) and really odd RUNs after the first one. To repair this problem, just load the missing REM version from the disk and type in the REMs. To avoid having this problem occur, begin any session of correction by loading the program, running it to make the REMs disappear, then loading it again to bring the REMs back; this time the REMs will not disappear when you run the program since the start-of-program pointer has already been changed.

SYNTHESIZER INITIALIZATION

If you have a line which sets SLOT and UNITS, like the one in ENTRY or PLAY, you can use these variables in a synthesizer initialization routine. Generally, any program which uses the synthesizer should have this initialization routine near the beginning. It is the same for either Integer BASIC or Applesoft.

```
FOR S=SLOT TO SLOT+UNITS-1
PN=16*S-16256 : POKE PN,0 : POKE PN+1,0 : POKE PN+2,0
POKE PN+3,3 : POKE PN+7,54 : POKE PN+7,118 : POKE PN+7,182
NEXT S
```

SONG CONFIGURATION

Unless you can configure each song for your particular system (using ENTRY, as previously described) and can count on your program being used only on your system, you will need a song configuration routine. This routine uses SLOT and UNITS, as does the synthesizer initialization routine (above). It also needs the variable A set to the starting address of the song to be configured.

The Integer BASIC version looks like this: (note: the song must not occupy address 32768)

```
FOR B=1 TO PEEK(A)
PNTR=PEEK(B+B+A-1)+PEEK(B+B+A)*256+A : CHAN=B-1
IF UNITS>1 THEN CHAN=PEEK(PNTR+2)/(1+15*(3-UNITS))
CHAN=CHAN MOD 16 : POKE PNTR+1,CHAN/4*12+CHAN+SLOT*16
NEXT B
```

The Applesoft version looks like this:

```
FOR B=1 TO PEEK(A)
PNTR=PEEK(B+B+A-1)+PEEK(B+B+A)*256+A : CHAN=B-1
IF UNITS>1 THEN CHAN=PEEK(PNTR+2)/(1+15*(3-UNITS))
CHAN=CHAN-INT(CHAN/16)*16 : POKE PNTR+1,INT(CHAN/4)*12+CHAN+SLOT*16
NEXT B
```

When using either version, you might wish to add POKE 2048,A MOD 256 : POKE 2049,A/256 : CALL 2050 : RETURN (which is POKE 2048,A-INT(A/256)*256 : POKE 2049,A/256 : CALL 2050 : RETURN in Applesoft) to the end in order to create a subroutine which can be GOSUBed in order to configure and play the song at address A.

READING THE "SUGGESTED SPEED"

Assuming the song was just loaded using PRINT "dLOAD song name,A";A the

suggested speed from an ENTRY-created song can be read into the variable S with the following statement: $S=PEEK(PEEK(-21920)+PEEK(-21919)*256+A-161)$. Note that the entire song must be located below memory address 32768 when using Integer BASIC. The -21920 is for a 48K system and must be -38304 on a 32K system. Likewise, the -21919 must be -38303 on a 32K system. In either case, Apple's DOS 3.2 must be used.

TEMPO CONTROL

If you wish to use a different paddle than Paddle 0 to control the playback speed, you must POKE 2345,n where n is the paddle number plus 100. (For a fixed playback speed, you may wish to install a 150K ohm 1/4 watt resistor at the game paddle connector between the +5 and PDL3 pins; then select paddle 3 for playback control as just described. Paddle 3 is an ideal choice since there is no switch input for this paddle, which may prohibit use of a real paddle. For additional information, request application note AN80-1.)

The following routine modifies PERFORM for timing mode and initializes channel 0 of the proper synthesizer for timing mode operation. Tslot must be set to the slot number of the timing mode input board, or to 8 when the game I/O input is used, as it is for ENTRY and PLAY.

```
S=(SLOT+(UNITS>1))*16+132 : POKE 2113,S : POKE 2118,S
POKE 2345,99+(Tslot*16+29)*(Tslot<8) : POKE 2347,16
POKE S-16388,0 : POKE S-16381,48
```

To go to normal mode, use: POKE 2113,32 : POKE 2118,112 : POKE 2345,100 : POKE 2347,48 : POKE (SLOT+(UNITS>1))*16-16249,54. Note that the POKE 2345,100 should be 100 plus the paddle number. The last poke (with SLOT and UNITS) is needed only if the synthesizer is not going to be initialized prior to its next use.

A SAMPLE SESSION

The following sample session is for a 48K system with Integer BASIC and Apple's DOS 3.2. The changes necessary for a 32K system or for Applesoft (or both) have already been discussed above. It is assumed that the PERFORM program and the M:MUSETTE song, as provided with the synthesizer, are already on disk.

```
>LOAD PERFORM
>DELETE PERFORM
>RUN
PERFORM ALF PRODUCTS INC.

>BSAVE PERFORM,A2050,L676
```

CONVERT PERFORM TO A BINARY FILE

```
>INT
>10 POKE 76,0 : POKE 77,124 : DIM A$(40) : INPUT "SONG NAME?",A$
>20 PRINT "dLOADM:";A$ : A=PEEK(202)+PEEK(203)*256
>30 PRINT "dBSAVE";A$;"A";A;"L";31744-A : PRINT "LENGTH: ";31744-A
>40 PRINT "dINT"
>SAVE CONVERT
>RUN
SONG NAME?MUSETTE
```

**SAVE
CONVERT
PROGRAM**

**CONVERT
MUSETTE
TO BINARY**

LENGTH: 1146

```
>5 POKE 74,0 : POKE 204,0 : POKE 75,64 : POKE 205,64 PROTECT PERFORM
>10 SLOT=4 : UNITS=1 (CHANGE AS REQUIRED) AND SONG AREA
>20 TSLOT=8
>30 PRINT "dBLOAD PERFORM" : DIM A$(40) LOAD PERFORM
>40 FOR S=SLOT TO SLOT+UNITS-1 INITIALIZE SYNTHESIZER
>50 PN=16*S-16256 : POKE PN,0 : POKE PN+1,0 : POKE PN+2,0
>60 POKE PN+3,3 : POKE PN+7,54 : POKE PN+7,118 : POKE PN+7,182
>70 NEXT S
>80 INPUT "SONG NAME?",A$ : A=2960 : PRINT "dBLOAD";A$;"A";A READ SONG
>90 S=PEEK(PEEK(-21920)+PEEK(-21919)*256+A-161) READ SUGGESTED SPEED
>100 IF S THEN 140
>110 S=(SLOT+(UNITS>1))*16+132 : POKE 2113,S : POKE 2118,S TIMING MODE
>120 POKE 2345,99+(TSLOT*16+29)*(TSLOT<8) : POKE 2347,16
>130 POKE S-16388,0 : POKE S-16381,48 : GOTO 180
>140 POKE 2113,32 : POKE 2118,112 : POKE 2345,100 NORMAL MODE
>150 POKE 2347,48 : POKE (SLOT+(UNITS>1))*16-16249,54
>160 PRINT "SUGGESTED SPEED: ";S
>170 PRINT PDL(0);" " ; : TAB 1 : IF PEEK(-16287)<128 THEN 170
>180 FOR B=1 TO PEEK(A) EITHER MODE: CONFIGURE SONG
>190 PNTR=PEEK(B+B+A-1)+PEEK(B+B+A)*256+A : CHAN=B-1
>200 IF UNITS>1 THEN CHAN=PEEK(PNTR+2)/(1+15*(3-UNITS))
>210 CHAN=CHAN MOD 16 : POKE PNTR+1,CHAN/4*12+CHAN+SLOT*16
>220 NEXT B : POKE 2048,A MOD 256 : POKE 2049,A/256
>230 CALL 2050 : GOTO 80 PLAY THE SONG
>SAVE YALP
>RUN
SONG NAME?MUSETTE
```

CREATION OF A SIMPLE PROGRAM

SUGGESTED SPEED: 190

(etc.) **(SONG PLAYS WHEN BUTTON IS PRESSED)**

TECHNICAL

PERFORM operates on one to nine sequences of commands stored in memory. Each sequence of commands indicates the sounds for one channel on one synthesizer. All the sequences will appear to be executed at the same time by PERFORM. There are three types of commands which may be used. One type is used to control the execution of the commands. Another type is used to set parameters for future use. The remaining type of command is used to wait or to produce a new pitch and wait. During the time "waited", PERFORM will automatically program volume settings which create the selected envelopes. Envelope production is explained in the ENTRY section and in the block diagram at the end of this section.

All commands for PERFORM are three bytes long. (Each byte is an integer from 0 to 255.) The first byte always indicates the particular command desired, and the second and third bytes indicate a parameter for use by that command. When the parameter is a two-byte integer (0 to 65535), the low byte (value MOD 256) is given as the second byte of the command and the high byte (value/256) is given as the third byte. The various commands available are described below.

TYPE A COMMANDS

The first type of command is used to control execution. They are CHANNEL NUMBER, CALL, RETURN, STOP, and END.

CHANNEL NUMBER

The CHANNEL NUMBER command is used to indicate the slot and channel number to be programmed. The second byte should be 16 times the expansion slot number plus the channel number. Although PERFORM does not use the third byte, it should be used to indicate stereo positioning. Its most significant four bits indicate stereo positioning for performance with two units (meaningless in songs that have more than six parts), and the least significant four bits indicate stereo positioning for performance with three units. In each half byte, the two most significant bits indicate the relative unit number (0 to 2). This number can be added to SLOT to create the actual unit number. The two least significant bits indicate the channel number (0 to 2). Thus, the second byte must be computed by multiplying the "actual unit number" (above) by 16 and adding the "channel number". The first command in each part must be a CHANNEL NUMBER command. ENTRY compatible songs may have only one CHANNEL NUMBER command per part.

CALL

The CALL command is used to perform a subroutine call. The second and third bytes indicate the relative address of the subroutine. During playback, the commands in the subroutine will be executed, and then PERFORM will continue in

the usual fashion with the commands following the CALL.

RETURN

The RETURN command marks the end of a subroutine, and causes PERFORM to continue at the commands following the CALL. The second and third bytes must be the same as the second and third bytes of the CALL command. ENTRY compatible songs may have only one RETURN command per subroutine.

STOP

The STOP command indicates the end of one part's (or channel's) commands. The envelope generator will continue to operate after a STOP command if no other channel has encountered an END command. The second and third bytes are not used and should be set to \emptyset . All parts except the last one should end with a STOP command. ENTRY compatible songs may have only one STOP command per part.

END

The END command is used to terminate PERFORM and return to the calling program. The last part should end with an END command rather than a STOP command. Further, the END command should be positioned as the last command in all the data (in ENTRY compatible songs, this is followed by the "suggested speed" byte and the 16 \emptyset title bytes). Envelope production does not continue once any part executes an END command. The second and third bytes are not used, and should be set to \emptyset .

TYPE B COMMANDS

The second type of command is used to set parameters. They are TRANSPOSE, GAP SIZE, ATTACK RATE, DECAY RATE, VOLUME LEVEL, SUSTAIN LEVEL, and RELEASE RATE.

TRANSPOSE

The TRANSPOSE command is used to add or subtract a constant from all following pitches (until a new TRANSPOSE value is programmed). The second byte indicates the amount to add or subtract. \emptyset to 127 will add a value of \emptyset to 127. 128 to 255 will subtract a value of 128 to 1. Since the values are in quarter-steps, adding a value of 24 will raise the pitch by one octave. The third byte is the pitch mask byte. All following pitch values are ANDed with the pitch mask byte (before the second byte transpose value is added or subtracted). This byte is normally set to 255. ENTRY compatible songs use a value of 254 to allow sharp/flat display selection with the least significant pitch bit.

GAP SIZE

The GAP SIZE command is used to control the release stage of envelope production. When the number of time periods remaining to wait (during a "wait")

equals the GAP SIZE value, the envelope parameters will automatically be changed. The RELEASE RATE value will be copied into the CURRENT DECAY RATE, and a 0 will be written into the DESIRED LOUDNESS and the CURRENT SUSTAIN LEVEL. This causes the CURRENT LOUDNESS (and therefore the volume) of the channel to drop to 0 at the RELEASE RATE. The second and third bytes indicate the new GAP SIZE. When a release stage is not desired, the GAP SIZE should be set to 65535 (255,255).

ATTACK RATE, DECAY RATE, VOLUME LEVEL, SUSTAIN LEVEL, RELEASE RATE

These commands are used to set envelope parameters. The second and third bytes indicate the new value.

TYPE C COMMANDS

The third type of command is used to wait or to produce a new pitch and wait. The second and third bytes indicate the number of time periods to wait before continuing with the next command. During this wait, the envelope generator program in PERFORM will update the envelope parameters and reprogram the volume once each time period. These commands are PITCH and REST.

PITCH

There are 192 PITCH commands with command numbers from 0 to 191. The command number indicates which pitch is to be produced, subject to modification by the two TRANPOSE parameters. The resultant number specifies the pitch to be programmed into the synthesizer. Pitch specification is in quarter-steps, with 0 being A natural at 27.5 Hz. There are 24 quarter-steps per octave. Thus, 24 is A natural at 55 Hz. Note that in ENTRY compatible songs, the least significant bit of the PITCH command number indicates whether sharp or flat should be displayed, and is masked off during playback (see TRANPOSE). The PITCH command also changes certain envelope parameters. The DECAY RATE is copied into the CURRENT DECAY RATE, the VOLUME LEVEL is copied into the DESIRED LOUDNESS, and the SUSTAIN LEVEL is copied into the CURRENT SUSTAIN LEVEL (see the block diagram at the end of this section).

REST

The REST command causes the RELEASE RATE to be copied into the CURRENT DECAY RATE, and a 0 to be written into the DESIRED LOUDNESS and the CURRENT SUSTAIN LEVEL. This causes the release portion of the envelope to begin. (Note: this is the same process as caused by the time remaining equaling the GAP SIZE, see the GAP SIZE command.)

SONG DATA

RELATIVE ADDRESSES

All relative addresses used in PERFORM (for example, the second and third bytes

of a CALL command) must be two-byte integers stored low byte first. The value stored must be the actual memory address minus the starting address of the song data.

START OF DATA

The first byte (stored at the starting address) must be the number of "parts" of data. This must be an integer from 1 to 9. The following 2 to 18 bytes must be the relative address of the first command of each part. Following these bytes the subroutines (if any) are stored, and then the first part's commands, the second's, and so forth. See the diagram below.

Two Part Song Data

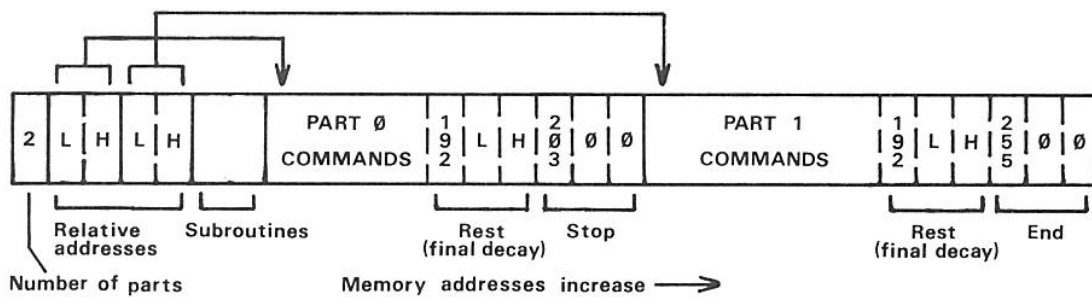

PART DATA

In each part, the three-byte commands are stored one after another. Each part must begin with a CHANNEL NUMBER command, and end with a STOP command (except the last part must end with an END command). See the diagram above. Although a part may contain more than one CHANNEL command, to do so would be incompatible with ENTRY and with the "song configuration" routine given earlier in this section.

SUBROUTINE DATA

The relative calling address to a subroutine must point to several bytes of reserved storage which precede the first command of the subroutine. There must be two times as many reserved bytes as the number of parts. These reserved bytes must be preceded by at least 1 additional byte(s), and the number of additional bytes plus the number of reserved bytes must be evenly divisible by 3. See the diagram below.

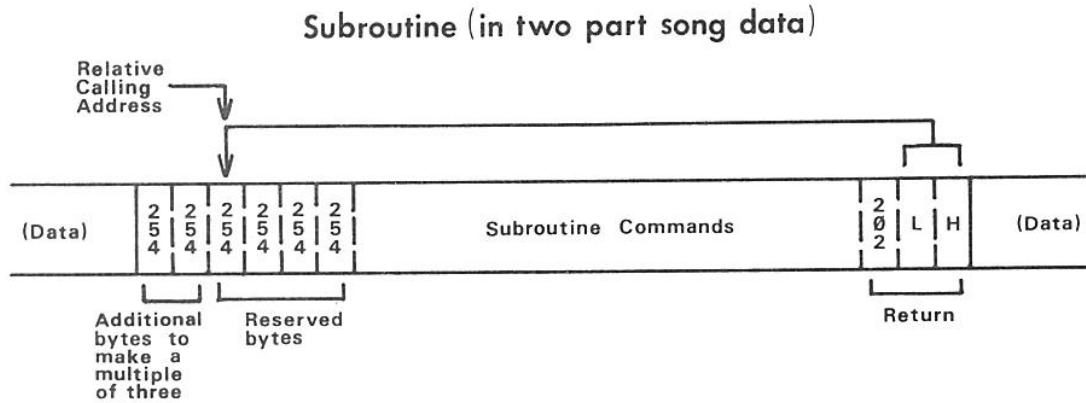

Note that the calling address must point to the first of the reserved bytes, not to the additional bytes nor to the first command in the subroutine. The additional bytes must be stored as 254's, and the reserved bytes should be set to 254 also. When a CALL command is executed during playback, the address of the first command after the CALL (that is, the return address) is stored in two of the reserved bytes. (PERFORM assigns a different pair of bytes for each part. This allows several parts to call the subroutine at once.) The RETURN command at the end of the subroutine causes the address of the next-command-to-be-interpreted to be read from the correct pair of reserved bytes, thus causing a "return". Note that although a subroutine may contain more than one RETURN command (or a RETURN command to a different subroutine), to do so would be incompatible with ENTRY.

TEMPO COMMAND

The TEMPO command is a rather unusual command. It is used to dynamically control playback tempo (speed). At the start of each time period, a two byte value is written to a selected synthesizer's channel 0 (only when using Timing Mode). This channel must have been previously initialized to Timing Mode. This two byte value determines the length of a time period, which will be value/1782000 seconds. The second and third bytes of the TEMPO command indicate a new value. Since the Timing Mode synthesizer channel controls the playback speed for all parts, the TEMPO command can appear in any part. Note that when using Timing Mode, channel 0 of one synthesizer (the higher numbered slot when using two synthesizers, or the middle slot when using three) cannot be used to play music. Its volume should be programmed to 0.

TEMPORARIES

PERFORM uses locations 0-19 (hex) (6-C and DD-EF for the Applesoft version) for storage of temporary values during execution.

COMMAND NUMBERS

HEX	DECIMAL	COMMAND
0-BF	0-191	PITCH
C0	192	REST
C1	193	GAP SIZE
C2	194	TRANSPOSE
C3	195	ATTACK RATE
C4	196	DECAY RATE
C5	197	VOLUME LEVEL
C6	198	SUSTAIN LEVEL
C7	199	RELEASE RATE
C8	200	CHANNEL NUMBER
C9	201	CALL
CA	202	RETURN
CB	203	STOP
CC	204	TEMPO
CD-FD	205-253	no operation
FE	254	preceeds subroutines, treated as END if found
FF	255	END

BLOCK DIAGRAM

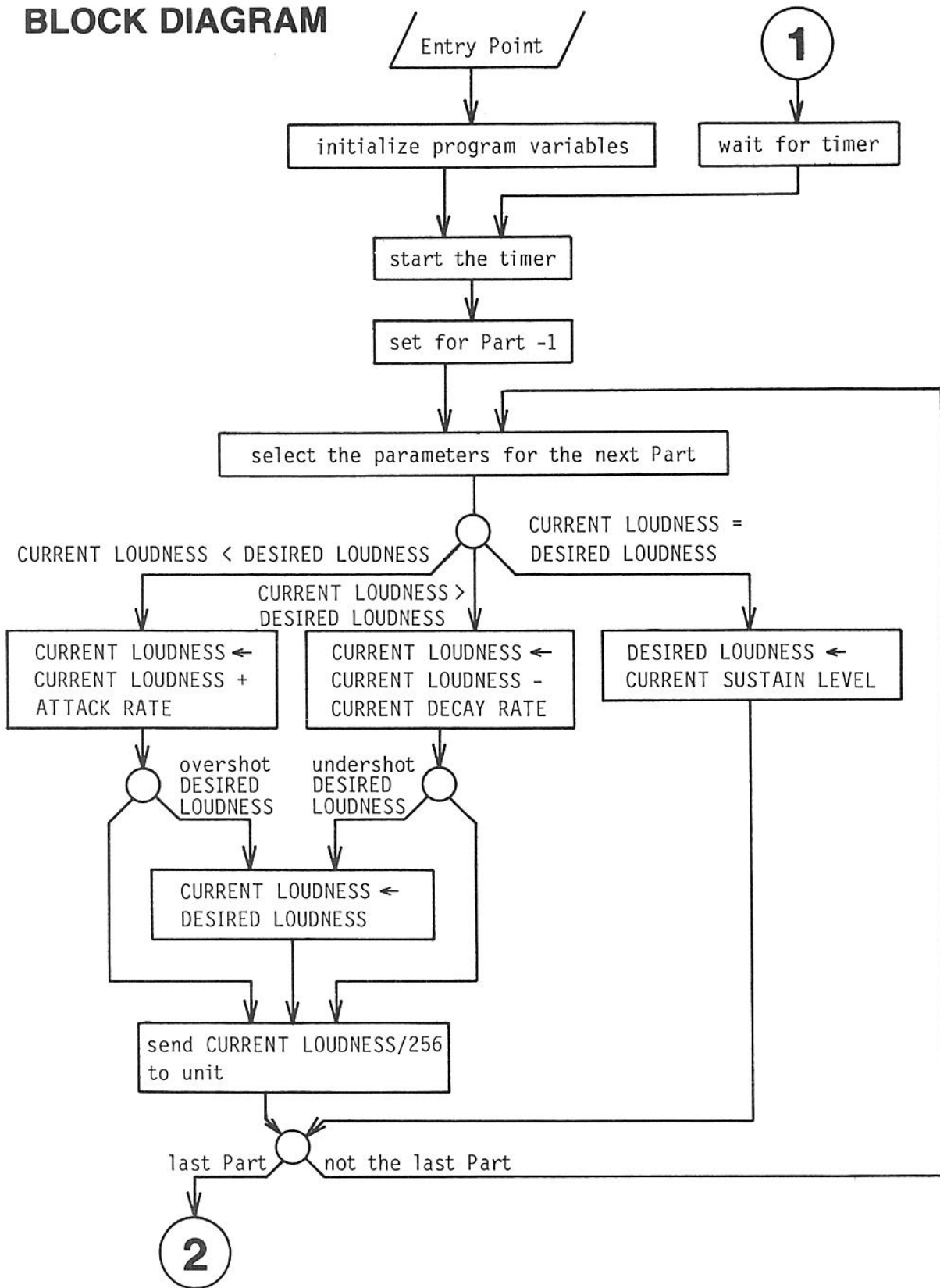

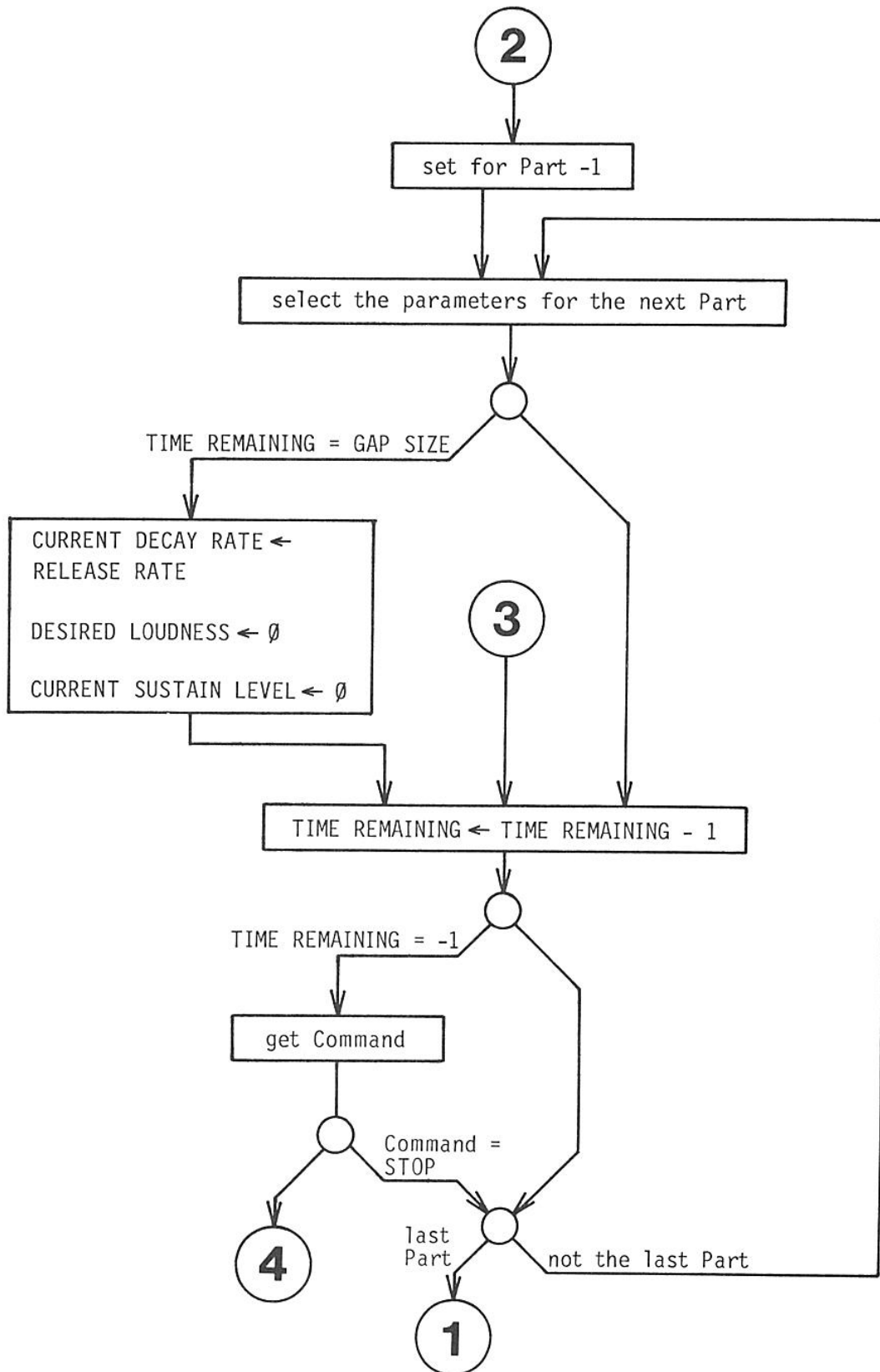

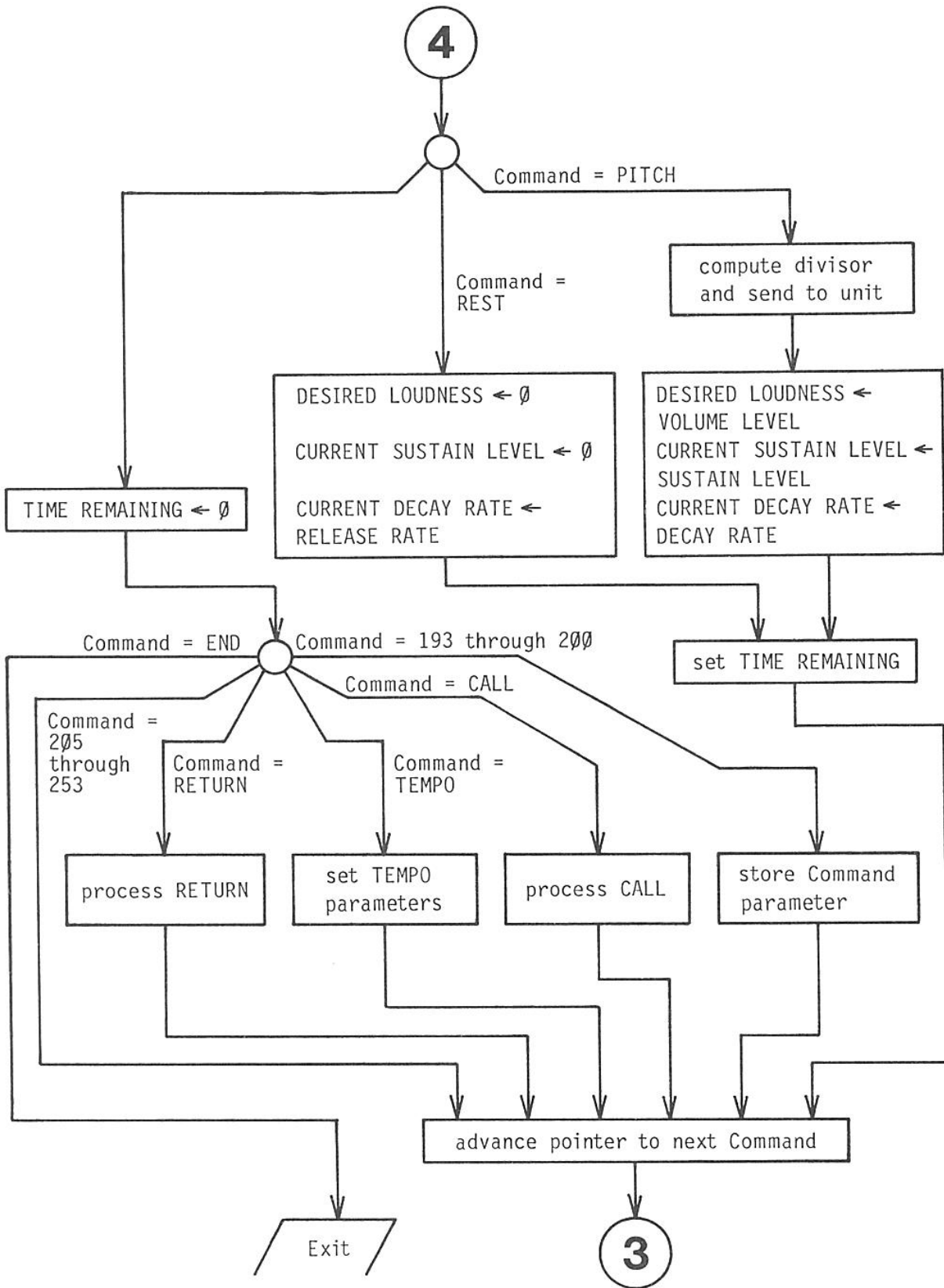

7

PROGRAMMING

WITH CHROMA

The CHROMA subroutine is used to simplify programming the synthesizer with chromatic (equal tempered) pitches. The various routines in CHROMA are:

1. **INITIALIZER.** Written in BASIC, this routine initializes the synthesizer, the CHROMA routine, and the PULSE routine.
2. **PARTIAL INITIALIZER.** Written in BASIC, this routine is used to initialize additional synthesizers.
3. **CHROMA.** Written in 6502 assembly language, this routine is used to program "normal mode" (square wave) pitches.
4. **PULSE.** Written in 6502 assembly language, this routine is used to program "pulse mode" (pulse wave) pitches.

The parameters required by these routines, their calling procedures, functions, and results are described below.

INITIALIZER

The INITIALIZER uses the value of the variable SLOT. Prior to calling the INITIALIZER, this variable should be set to the expansion slot number one of your synthesizers is plugged into. The INITIALIZER is called using GOSUB 32767. It will initialize the synthesizer, correct memory addresses in the CHROMA and PULSE routines, assign values to the variables PITCH and VOL0, and poke SLOT*16 at PITCH+2 and 0 at PITCH+3 (see table below). "Initialize the synthesizer" means to set all three channels to zero volume and "normal mode".

POKE ADDRESS	NAME	DESCRIPTION
PITCH	PITCH	Pitch number
PITCH+1	PART	Channel (part) number
PITCH+2		Slot number times 16
PITCH+3	OFFSET	Pitch offset
PITCH+4	WIDTH	Pulse width
PITCH+5		Divisor low
PITCH+6		Divisor high
PITCH+7	CHROMA	CHROMA entry point
(PITCH+8 and PITCH+9 are reserved.)		
PITCH+10	PULSE	PULSE entry point
(PITCH+11 and PITCH+12 are reserved.)		
PITCH+13		(start of divisor table)

The table above shows the memory locations used for parameter storage by the CHROMA and PULSE routines. The address of this table is indicated by the value assigned to PITCH, which is based on the value of HIMEM (or the length of your program when using Applesoft). Note that when using Integer BASIC, HIMEM must

not be -32498, -32433, or any value in between.

The variable VOL \emptyset is used to set volume levels and change modes.

POKE ADDRESS	NAME	DESCRIPTION
VOL \emptyset	VOL \emptyset	Volume for channel \emptyset
VOL \emptyset +1	VOL1	Volume for channel 1
VOL \emptyset +2	VOL2	Volume for channel 2
VOL \emptyset +3		Mode control A
VOL \emptyset +7		Mode control B

Values poked at the above addresses go directly to the synthesizer and cause the volume or mode to change immediately. Values from \emptyset to 255 can be poked for volume (\emptyset =off or 1=soft to 255=loud). The following values can be poked for mode control (other values should not be used).

POKE ADDRESS	VALUE	FUNCTION
VOL \emptyset +3	\emptyset	Both channels \emptyset and 1 to pulse mode
VOL \emptyset +3	1	Channel \emptyset to normal mode, channel 1 to pulse mode
VOL \emptyset +3	2	Channel \emptyset to pulse mode, channel 1 to normal mode
VOL \emptyset +3	3	Both channels \emptyset and 1 to normal mode
VOL \emptyset +7	5 \emptyset	Channel \emptyset to pulse mode
VOL \emptyset +7	54	Channel \emptyset to normal mode
VOL \emptyset +7	114	Channel 1 to pulse mode
VOL \emptyset +7	118	Channel 1 to normal mode
VOL \emptyset +7	182	Channel 2 to normal mode (used by the INITIALIZER)

The INITIALIZER and PARTIAL INITIALIZER set all three channels to normal mode. To change modes, set the mode by poking the value shown above to VOL \emptyset +7, then the appropriate value (above) to VOL \emptyset +3.

The value assigned to VOL \emptyset by the INITIALIZER or PARTIAL INITIALIZER is different for each expansion slot and is calculated by the formula VOL \emptyset =SLOT*16-16256.

The mnemonic variable names shown in the first table can be set using the following statements. (Note: the variable name PART was given as CHANNEL, which is more appropriate, in previous manuals. However, Applesoft does not allow two variables to be named CHANNEL and CHROMA.) The setup and calling of the INITIALIZER is included:

```
1 $\emptyset$  SLOT=4      (replace 4 with the proper slot number)
2 $\emptyset$  GOSUB 32767 : PART=PITCH+1 : OFFSET=PITCH+3 : WIDTH=PITCH+4 :
      CHROMA=PITCH+7 : PULSE=PITCH+1 $\emptyset$  : VOL1=VOL $\emptyset$ +1 : VOL2=VOL $\emptyset$ +2
```

NOTE: Applesoft does not allow three variables to be named VOL \emptyset , VOL1, and VOL2. Applesoft users should pick names for VOL1 and VOL2 (if they need these variables) which do not begin with the same 2 letters as any other variable, and complain to Microsoft.

PARTIAL INITIALIZER

When more than one synthesizer is used, the units not initialized with the INITIALIZER (GOSUB 32767) must be initialized with the PARTIAL INITIALIZER. For each additional board, set SLOT to the proper expansion slot number, and call the PARTIAL INITIALIZER using GOSUB -2. It will initialize the synthesizer and set VOLØ to the volume control address for that slot number. Previous values of VOLØ set by the INITIALIZER or PARTIAL INITIALIZER should be assigned to other variables if they must be retained. (The value of VOLØ for any slot is computed by the formula $VOLØ = SLOT * 16 - 16256$.) Note that GOSUB -2 does not cause the slot number times 16 to be written at PITCH+2 or a zero to be written at PITCH+3. GOSUB -3 can be used instead if you wish to have these values poked. (On systems where Applesoft doesn't allow GOSUB with negative numbers, use 63998 instead of -2 and 63997 instead of -3.)

CHROMA

CHROMA uses the parameters poked at PITCH, PART, PITCH+2, and OFFSET. It changes the contents of PITCH+5 and PITCH+6. When called using CALL CHROMA (or CALL PITCH+7), CHROMA programs the desired channel (indicated by PART) on the desired synthesis board (indicated by the slot number times 16 at PITCH+2) with the desired pitch (indicated by PITCH and OFFSET). To do this, CHROMA will calculate a two-byte divisor which it stores at PITCH+5 and PITCH+6 in case it is needed for PULSE (see the PULSE routine in this section). The precise function of these poked parameters is as follows:

PART (PITCH+1)

This indicates which of the three channels is to be programmed. It must be an integer from Ø to 2. Adding 128 will inhibit programming of the synthesizer but the divisor will still be computed and stored.

PITCH+2

This indicates the slot number of the synthesizer to be programmed. The value poked must be the slot number (Ø to 7) times 16. If only one synthesizer is used, this parameter does not need to be poked since it is initialized to $SLOT * 16$ by the INITIALIZER.

PITCH

This indicates the quarter-tone pitch to be programmed. The values for half-tones in the lowest octave are:

0	A	8	C sharp	16	F
2	A sharp	10	D	18	F sharp
4	B	12	D sharp	20	G
6	C	14	E	22	G sharp

For quarter-tones, add 1. For higher octaves, add the numbers shown below to the numbers shown above. The frequency of the A in that octave is also shown below. (Note: "octaves" here start at A.)

A (Hz)	Add	A (Hz)	Add	A (Hz)	Add	A (Hz)	Add
27.5	0	110	48	440	96	1760	144
55	24	220	72	880	120	3520	168

The highest pitch (G sharp plus a quarter-step) in the highest octave is 22+1+168 (or 191), so pitch values should be from 0 to 191. Some common notes and their values are (for sharp, add 2; for flat, subtract 2):

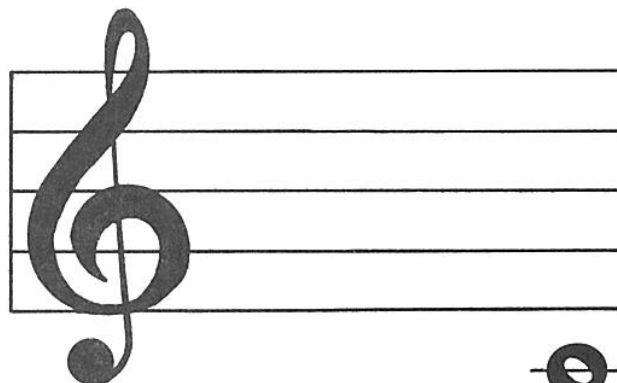
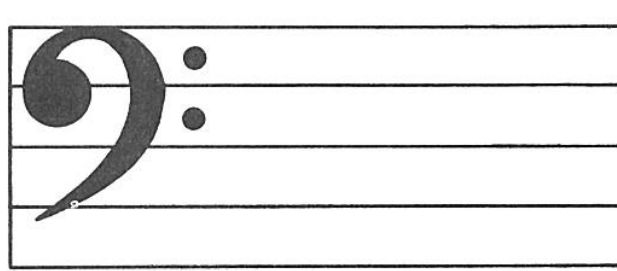
	Hex	Decimal	Note
	70	112	F
	6E	110	E
	6A	106	D
	66	102	C
	64	100	B
	60	96	A 440
	5C	92	G
	58	88	F
	56	86	E
	52	82	D
	4E	78	Middle C
	4C	76	B
	48	72	A
	44	68	G
	40	64	F
	3E	62	E
	3A	58	D
	36	54	C
	34	52	B
	30	48	A
2C	44	G	

OFFSET (PITCH+3)

This indicates how sharp the pitch should be from standard tuning. 0 is used for standard A=440 Hz tuning (as initialized by GOSUB 32767 or GOSUB -3), and numbers from 1 to 255 are used to raise the pitch slightly. All pitches selected using OFFSET are less than or equal to the pitch selected by a PITCH setting one higher. Note that the pitches selected by various values of PITCH increase exponentially, whereas the pitches selected by various values of OFFSET (with a constant PITCH setting) increase linearly.

PULSE

The PULSE routine is used to create pulse waves using channel 0 and/or channel 1. The frequency (pitch) of the pulse wave will be the same as the frequency of channel 2. The INITIALIZER sets all channels to normal mode, so channels to be used with PULSE must be changed to "pulse mode" as previously described. The parameters poked at PART, PITCH+2, WIDTH, PITCH+5, and at PITCH+6 are used. PULSE is called using CALL PULSE (or CALL PITCH+10). The precise function of each parameter is as follows:

PART (PITCH+1)

This indicates which of the two channels is to be programmed. It must be either 0 or 1. Adding 128 will inhibit programming of the synthesizer but the divisor will still be calculated and stored (see divisor storage locations below).

PITCH+2

This indicates the slot number of the synthesizer to be programmed. The value must be the slot number (0 to 7) times 16.

WIDTH (PITCH+4)

This indicates the width of the low part of each cycle. Numbers from 0 to 126 indicate a short low portion, and numbers from 128 to 255 indicate a long low portion. 127 is used to program a square waveform.

PITCH+5 and PITCH+6

These must contain the divisor currently programmed for channel 2. If CHROMA was called most recently for channel 2, these locations will already be set to the divisor (by CHROMA).

The divisor calculated by PULSE is stored at locations 81 and 82 decimal (61 and 62 in Applesoft). It may be read using peek immediately after calling PULSE.

CHROMA EXAMPLE

To program a three note chord of Middle C, E, G at maximum volume, begin by loading CHROMA. Now type in the following program, remembering to change the 4 to the correct expansion slot number.

```
10 SLOT=4
20 GOSUB 32767 : PART=PITCH+1 : OFFSET=PITCH+3 : CHROMA=PITCH+7
30 POKE PART,0 : POKE PITCH,78 : CALL CHROMA : POKE VOL0,255
40 POKE PART,1 : POKE PITCH,86 : CALL CHROMA : POKE VOL0+1,255
50 POKE PART,2 : POKE PITCH,92 : CALL CHROMA : POKE VOL0+2,255
60 END
```

Now run the program. The synthesizer will be programmed for the C E G chord, and it will continue to produce the chord until programmed to do something else. The chord can be cleared by typing GOTO -2.

PULSE EXAMPLE

The following program produces one tone with the pitch controlled by Paddle 0 and the pulse width controlled by Paddle 1. As in the above example, begin by loading CHROMA. Then add the program below, remembering to correct the slot number.

```
10 SLOT=4
20 GOSUB 32767 : PART=PITCH+1 : WIDTH=PITCH+4
30 CHROMA=PITCH+7 : PULSE=PITCH+10 : POKE VOL0+7,50 : POKE VOL0+3,2
40 POKE PART,2 : POKE PITCH,PDL(0)/2 : CALL CHROMA
50 POKE PART,0 : POKE WIDTH,PDL(1) : CALL PULSE
60 POKE VOL0,255 : GOTO 40
```

Now run the program, and twist the paddle knobs like mad. Stop the program, and type POKE VOL0,0 to stop the noise.

8

PROGRAMMING

BARE HANDED

The Apple Music Synthesizer is programmed by means of 8 "ports". Each port is assigned a particular memory address, and information can be sent to a port by writing a byte (an integer from 0 to 255) to that memory address (using 6502 Assembly Language or BASIC's POKE). Reading from these memory addresses does not affect the synthesizer. The ports are numbered from 0 to 7. The memory address of each port is calculated by the formula $SLOT*16-16256+P$ where SLOT is the expansion slot number used by the synthesizer and P is the desired port number (both should be 0 to 7).

The function of each port is as follows:

PORT	FUNCTION
0	Volume control for channel 0
1	Volume control for channel 1
2	Volume control for channel 2
3	Mode control A
4	Divisor for channel 0
5	Divisor for channel 1
6	Divisor for channel 2
7	Mode control B

Ports 0-2 are used to control the volume. A byte written to one of these ports will cause the volume of the appropriate channel to change immediately to the new value (0=off or 1=soft to 255=loud). The relative output voltage for any volume setting (VOL) is computed by $2^{\uparrow}(VOL/32)*(VOL \text{ MOD } 32 + 33)-33$ with Integer BASIC, or by $2^{\uparrow}INT(VOL/32)*(VOL-INT(VOL/32)*32 + 33)-33$ with Applesoft BASIC.

Ports 3 and 7 are used for mode control. Before use, all channels must be initialized to either normal mode or pulse mode to insure proper operation. Port 3 selects whether the pitch control will be provided by the Apple or by the output of Channel 2. Port 7 selects whether the divisor will control the pitch or the pulse width. Normally both ports 3 and 7 are set to indicate either normal mode or pulse mode. Port 7 should be programmed before port 3 for best results.

The value written to port 3 has the following effects:

VALUE	MEANING
0	Both channels 0 and 1 to pulse mode
1	Channel 0 to normal mode, channel 1 to pulse mode
2	Channel 0 to pulse mode, channel 1 to normal mode
3	Both channels 0 and 1 to normal mode

Other values should not be used.

Values written to port 7 have the following effects:

VALUE MEANING

50	Set channel 0 to pulse mode, channels 1 and 2 not affected
54	Set channel 0 to normal mode, channels 1 and 2 not affected
114	Set channel 1 to pulse mode, channels 0 and 2 not affected
118	Set channel 1 to normal mode, channels 0 and 2 not affected
182	Set channel 2 to normal mode, channels 0 and 1 not affected

Other values should not be used except as noted in the TIMING MODE section.

When a channel is set to a mode using port 7, the output of its pitch generator will go high and stay high until both bytes of a divisor are written. The high part of the cycle will then begin. (Note: port 3 should be set after port 7 is set but before the first divisor is programmed.)

When a channel is set to pulse mode with port 7 but normal mode with port 3, the output of its pitch generator will stay high. When a channel is set to pulse mode with port 3 but normal mode with port 7, the output of its pitch generator will be high when the output of channel 2's pitch generator is low, and when the channel 2 output goes high the mixed-mode channel will begin normal square wave operation starting with the high part of the cycle. (Once the channel 2 output returns to low, the mixed-mode channel will go high and stay high until the channel 2 output goes high again.)

Any of the three channels can also be set to a special "timing mode" where the channel is used to simulate the Apple "paddle" timers, but with a programmable setting. See the TIMING MODE section for details.

Ports 4-6 are used to program the divisor. Once a channel has been initialized, it will be expecting the low byte of the divisor ($D \text{ MOD } 256$). Once the low byte is written, it will be expecting the high byte of the divisor ($D/256$). Once the high byte is written, the new divisor will be used by the pitch generator; and the low byte of the next divisor will be expected.

When in normal mode, the divisor determines the frequency to be produced by the pitch generator. The duty cycle is always approximately 50% and cannot be altered. The output frequency will be $1782000/D$ Hz (where D is the divisor programmed) plus or minus 0.015%. The value D must be an integer from 32 to 65536. (Note: 65536 must be programmed as 0. Values less than 32 are possible but should not be used.) When a new divisor is programmed, it does not take effect until the associated pitch generator's output goes high after the high byte of the divisor was written.

When in pulse mode, the divisor determines the time duration of the low portion

of the pulse wave. The frequency is determined by the frequency output of channel 2's pitch generator. Just after the low to high change of channel 2's pitch generator output, the output of the pulse mode channel's pitch generator will go low. It will stay low for $D/1782000$ seconds plus or minus 0.015%. If the channel 2 output has again gone high during this time, the pulse mode output will stay low. Otherwise, the pulse mode output will go high and stay high until the next time the channel 2 output goes high. The value D must be an integer from 1 to 65536. (Note: 65536 must be programmed as 0.) When a new divisor is programmed, it does not take effect until the first low to high change in the output of channel 2's pitch generator after the high byte of the divisor was written.

DIVISOR CALCULATION

Pitches and volumes must increase (and decrease) exponentially to achieve an apparent linear increase (for humans). Exponential volume increases are automatically created by the exponential amplifiers in the volume control circuitry. Exponential pitch increases must be created by selecting divisors which result in exponentially higher (and lower) pitches.

The most common exponential pitch spacing is the equal tempered scale, which is similar to the piano scale. This scale is divided into "octaves" with 12 notes per octave (half tones) or 24 notes per octave (quarter tones) depending on the application. An octave is defined to mean that the frequency of a note is twice that of the same note in the next lower octave. The frequency, $F(N)$, of any particular note, N , in an octave is calculated by $F(N)=F(0)*(2 \uparrow (N/X))$ where X is the number of notes per octave, $F(0)$ is the frequency (pitch) of the lowest note in the octave (in Hz, or cycles per second), and N must be an integer from 0 to $X-1$. (Note: although written in standard BASIC format, the formulas here are not intended to be computed in BASIC without careful consideration of the accuracy required. Floating-point calculation should be used in any case.) The frequency, $F(N,Q)$, of any given note, N , in any given octave, Q , is calculated $F(N,Q)=F(N,0)*(2 \uparrow Q)$ where $F(N,0)$ is equivalent to $F(N)$ in the previous formula and Q is an integer. The lowest note on a piano has a frequency of 27.5 Hz (using standard $A=440$ Hz tuning). Thus the frequency, $F(N,Q)$, of any piano note is $F(N,Q)=27.5*(2 \uparrow (Q+N/12))$ Hz, where N is the note number from 0 to 11 and Q is the octave number from 0 to 7. (Note: pianos have no notes where N is greater than 3 if Q is 7. $N=0$ indicates an A natural pitch.) Therefore the desired divisors for piano notes are: $D(N,Q)=INT(1782000/(27.5*(2 \uparrow (Q+N/12))))+0.5$. Note that the 12 can be replaced with a 24 (and the range of N extended to 0-23) to obtain quarter tones. It is usually convenient to calculate divisors using a small look-up table containing $D(N,0)$ and dividing by $2 \uparrow Q$ and rounding. This is easily accomplished in assembly language by shifting the divisor right Q times (shifting in 0's) and then adding in the last bit shifted out in order to round.

TUNING

It may be useful to know that musicians use "cents" to express the amount of deviation from correct tuning for half tones. A note too high (sharp) by 100 cents would be the right frequency for the next higher half step. The formula for cents is $(1200 * \text{LOG}(F/X)) / \text{LOG}(2)$ where X is the correct frequency in Hz and F is the actual frequency produced in Hz. (The LOG may be in any base, as long as it is always the same base.) Inaccurate tuning in the synthesizer's pitches results mainly from the fact that only integral values can be used for the divisor (D). This creates pitches out of tune by amounts varying from 0 to 0.020 cents in the lowest 12 notes of the piano scale, which increase to 0.067 to 1.204 cents in the top 12 notes. (The 0.015% crystal accuracy adds a maximum of 0.260 cents.) Tuning accuracy within 2 cents should be considered excellent and suitable for any purpose.

9

TIMING MODE

When playing songs with PERFORM (see the PERFORM section), song tempo (playback speed) is normally controlled by the setting of paddle 0. (Note: since both ENTRY and PLAY use PERFORM, this section applies to playback with ENTRY and PLAY as well as PERFORM.) The paddles on the Apple actually control hardware timers, which (when using the PDL functions) the software measures the time delay of in order to produce a number from 0 to 255. PERFORM uses this time delay to control the playback speed directly, so the physical positioning of the paddle knob (not the imaginary 0 to 255 number) adjusts the speed. In many applications, this may be undesirable. It is especially undesirable in two particularly common procedures. One is the use of DISCO for continuous playback of songs. Songs generally have a variety of paddle settings, and it is inconvenient to have to re-adjust the paddle knob position between each song. The second occurs in songs which have ritards or similar tempo changes from one section to another. It would be inconvenient to create such changes by manually adjusting the knob while the song plays.

Fortunately, the TEMPO command can be used to select any of a variety of playback speeds. (See the PERFORM and ENTRY sections.) However, the TEMPO command is only used when "timing mode" is activated. Timing mode is a special mode in which one channel of one synthesizer is programmed to function similar to the Apple paddle timers. The pitch programmed into that channel determines the delay time (and thus the playback speed) rather than a physical knob position. Naturally, this means that one synthesizer channel cannot be used for normal playback, since it is occupied with the timing tone.

The software provided with the synthesizer is only programmed for timing mode using channel 0 of a particular synthesizer. (The higher numbered slot when using 2 synthesizers, and the middle slot when using 3.) When writing your own software, any channel can be used.

CONNECTION

In order to use timing mode, the output of the channel to be used must be connected into the Apple's hardware so its status can be read. There are two simple ways to do this. The easiest method is to use the Timing Mode Input Board (ALF part number 10-5-17) which plugs into any expansion slot in the Apple, and connects to the empty socket on a synthesizer. However, if it is undesirable to use an additional slot, a channel output can be connected to the Apple Game I/O connector using a simple "header to header" cable (ALF part number 10-1-8), and the Game I/O Socket Extender (ALF part number 10-1-9) which allows both the game paddles and the header to header cable to be plugged in at the same time. Using either scheme, the cables are constructed to use channel 0 (as required by standard ALF software). Those who wish to make a header to header cable

themselves should connect pin 3 of a 14-pin DIP IC header (for the empty socket on the synthesizer) to pin 4 (switch input 2) of a 16-pin DIP IC header (for the Apple Game I/O socket).

ENTRY & PLAY

ENTRY and PLAY contain a line 2Ø which is normally 2Ø TSL0T=8. The 8 value selects the Game I/O connection method. Values from Ø to 7 select the Timing Mode Input Board connection method and also indicate which slot the TMIB is in. In either case, the header which plugs into the empty socket on the synthesizer must be connected to the higher numbered unit (the "right" unit) when using 2 synthesizers, or the middle unit when using 3.

It is important to note that the channel used for timing mode should not be assigned a part of the music. Thus, the number of parts which can be played when timing mode is activated (suggested speed=Ø) is 2, 5, or 8 (for 1, 2, or 3 synthesizers). When using the STEREO command (see the ENTRY section), you must remember that only 2 R's can be used if you have 2 units; or that only 2 M's can be used if you have 3 units. Since the assumed stereo for three units is MLRMLRLR (which would have 3 M's if 7 or 8 parts are used), this must be changed after each EDIT command if the number of parts is changed to 7 or 8.

Remember that each song must begin with a TEMPO command in one of the parts before the first note or rest (or CALL to a subroutine with a note or rest). Traditionally, this is done in Part Ø.

TECHNICAL

To initialize a channel to "timing mode", port 3 (mode control A) is set to "normal mode". The following value is sent to port 7 (mode control B): 48 for channel 0, 112 for channel 1, or 176 for channel 2. Note that no mode control A setting is required for channel 2. The pitch generator output of the selected channel will go low upon initialization. Volume for the timing mode channel should be set to 0 unless you wish to hear the timing tone.

To "set" the timer, a two byte divisor, D, is sent in the normal fashion (see the BARE HANDED programming section). The output will go low (or stay low if it is already low). After $D/1782000$ plus or minus 0.015% seconds, the output will go high, and stay high until the next divisor is programmed. This is the same as the Apple paddle timers, except the signal is inverted (the Apple timers go high when set and go low upon time-out).

10
LISTINGS

PERFORM (INTEGER VERSION)

```

0000      10      * PERFORM SUBROUTINE
0000      20      *
0000      30      * BY JOHN RIDGES
0000      40      *
0000      50      * ALF PRODUCTS INC.
0000      60      *
0000      70      *           ORG 0
0000      80      * BASE PAGE USAGE
0000      90      SPNTR   BSS 2           SONG DATA POINTER
0002     100     COUNT   BSS 1           PART COUNTER
0003     110     TEMP1   BSS 1
0004     120     TEMP2   BSS 1
0005     130     TEMP3   BSS 2
0007     140     PARNUM  BSS 19          NUMBER OF PARTS
0008     150     PARPNT  EQU PARNUM+1    PART POINTERS
0800     160     *           ORG $800
0800     170     * SUBROUTINE PARAMETER
0800     180     DPNTR   BSS 2           SONG DATA BEGINNING ADDRESS
0802     190     * SUBROUTINE ENTRY POINT
0802     8A     200     TXA           SAVE X
0803     48     210     PHA           REGISTER
0804     AD 00 08 220     LDA DPNTR    SET SONG
0807     85 00     230     STA /SPNTR  DATA POINTER
0809     AD 01 08 240     LDA DPNTR+1
080C     85 01     250     STA /SPNTR+1
080E     A0 00     260     LDY #0      GET NUMBER
0810     B1 00     270     LDA (SPNTR),Y OF PARTS
0812     0A     280     ASL A
0813     85 07     290     STA /PARNUM
0815     A2 00     300     LDX #0      SET UP
0817     C8     310     CPYADR  INY     PART POINTERS
0818     B1 00     320     LDA (SPNTR),Y
081A     18     330     CLC
081B     65 00     340     ADC /SPNTR
081D     95 08     350     STA /PARPNT,X
081F     E8     360     INX
0820     C8     370     INY
0821     B1 00     380     LDA (SPNTR),Y
0823     65 01     390     ADC /SPNTR+1
0825     95 08     400     STA /PARPNT,X
0827     E8     410     INX
0828     E4 07     420     CPX /PARNUM
082A     D0 EB     430     BNE CPYADR
082C     46 07     440     LSR /PARNUM
082E     A2 EA     450     LDX #234
0830     A9 00     460     LDA #0      CLEAR
0832     9D A5 0A 470     CLEAR  STA TIME-1,X  PARAMETER AREA
0835     CA     480     DEX
0836     D0 FA     490     BNE CLEAR
0838     500     * MAIN EXECUTION LOOP
0838     A5 07     510     LDA /PARNUM
083A     85 02     520     STA /COUNT
083C     A2 00     530     MAIN   LDX #0
083E     A9 00     540     PLACE1 LDA #0
0840     8D 20 C0 550     PLACE1 STA $C020
0843     A9 00     560     PLACE2 LDA #0
0845     8D 70 C0 570     PLACE2 STA $C070
0848     580     * ENVELOPE PROCESSING SECTION

```

0848	BD B8 0A	590	ENVEL	LDA LOUDNS,X	CHECK CL (CURRENT LOUDNESS)
084B	38	600		SEC	AND DL (DESIRED LOUDNESS)
084C	FD BC 0A	610		SBC DESIRE,X	
084F	85 03	620		STA /TEMP1	
0851	BD B9 0A	630		LDA LOUDNS+1,X	
0854	FD BD 0A	640		SBC DESIRE+1,X	
0857	90 12	650		BCC UPLD	BRANCH IF CL<DL
0859	05 03	660		ORA /TEMP1	
085B	D0 31	670		BNE DWNLD	BRANCH IF CL>DL
085D	BD BE 0A	680		LDA CURSUS,X	CL=DL
0860	9D BC 0A	690		STA DESIRE,X	DL:=CURRENT SUSTAIN LEVEL
0863	BD BF 0A	700		LDA CURSUS+1,X	
0866	9D BD 0A	710		STA DESIRE+1,X	
0869	B0 66	720		BCS NEXTE	
086B	BD B8 0A	730	UPLD	LDA LOUDNS,X	CL:=CL+ATTACK RATE
086E	7D AC 0A	740		ADC ATTACK,X	
0871	9D B8 0A	750		STA LOUDNS,X	
0874	BD B9 0A	760		LDA LOUDNS+1,X	
0877	7D AD 0A	770		ADC ATTACK+1,X	
087A	9D B9 0A	780		STA LOUDNS+1,X	
087D	B0 31	790		BCS ETHERE	BRANCH IF OVERSHOT DL
087F	A8	800		TAY	COMPARE CL AND DL
0880	BD B8 0A	810		LDA LOUDNS,X	
0883	DD BC 0A	820		CMP DESIRE,X	
0886	98	830		TYA	
0887	FD BD 0A	840		SBC DESIRE+1,X	
088A	90 3C	850		BCC SENDE	DON'T BRANCH IF OVERSHOT DL
088C	B0 22	860		BCS ETHERE	
088E	BD B8 0A	870	DWNLD	LDA LOUDNS,X	CL:=CL-CURRENT DECAY RATE
0891	FD BA 0A	880		SBC DOWN,X	
0894	9D B8 0A	890		STA LOUDNS,X	
0897	BD B9 0A	900		LDA LOUDNS+1,X	
089A	FD BB 0A	910		SBC DOWN+1,X	
089D	9D B9 0A	920		STA LOUDNS+1,X	
08A0	90 0E	930		BCC ETHERE	BRANCH IF UNDERSHOT DL
08A2	BD BC 0A	940		LDA DESIRE,X	COMPARE CL AND DL
08A5	DD B8 0A	950		CMP LOUDNS,X	
08A8	BD BD 0A	960		LDA DESIRE+1,X	
08AB	FD B9 0A	970		SBC LOUDNS+1,X	
08AE	90 18	980		BCC SENDE	DON'T BRANCH IF UNDERSHOT DL
08B0	BD BC 0A	990	ETHERE	LDA DESIRE,X	CL:=DL
08B3	9D B8 0A	1000		STA LOUDNS,X	
08B6	BD BD 0A	1010		LDA DESIRE+1,X	
08B9	9D B9 0A	1020		STA LOUDNS+1,X	
08BC	BD BE 0A	1030		LDA CURSUS,X	DL:=CURRENT SUSTAIN LEVEL
08BF	9D BC 0A	1040		STA DESIRE,X	
08C2	BD BF 0A	1050		LDA CURSUS+1,X	
08C5	9D BD 0A	1060		STA DESIRE+1,X	
08C8	BC B6 0A	1070	SENDE	LDY CHAN,X	SEND LOUDNESS
08CB	BD B9 0A	1080		LDA LOUDNS+1,X	TO UNIT
08CE	99 80 C0	1090		STA \$C080,Y	
08D1	8A	1100	NEXTE	TXA	REPEAT FOR
08D2	18	1110		CLC	NEXT PART
08D3	69 1A	1120		ADC #ASIZE	
08D5	AA	1130		TAX	
08D6	C6 02	1140		DEC /COUNT	
08D8	F0 03	1150		BEQ CONT1	
08DA	4C 48 08	1160		JMP ENVEL	
08DD	A2 00	1170	CONT1	LDX #0	INITIALIZE PART COUNTER
08DF		1180	* NOTE	DURATION SECTION	
08DF	BD A6 0A	1190	LENGTH	LDA TIME,X	COMPARE TIME REMAINING

08E2	DD A8 0A	1200	CMP GAP,X	AND GAP SIZE
08E5	D0 22	1210	BNE DECR	BRANCH IF UNEQUAL
08E7	BD A7 0A	1220	LDA TIME+1,X	
08EA	DD A9 0A	1230	CMP GAP+1,X	
08ED	D0 1A	1240	BNE DECR	BRANCH IF UNEQUAL
08EF	BD B4 0A	1250	LDA RELEAS,X	EQUAL; START NOTE
08F2	9D BA 0A	1260	STA DOWN,X	RELEASE
08F5	BD B5 0A	1270	LDA RELEAS+1,X	CURRENT DECAY RATE:=
08F8	9D BB 0A	1280	STA DOWN+1,X	RELEASE RATE
08FB	A9 00	1290	LDA #0	DL:=0
08FD	9D BC 0A	1300	STA DESIRE,X	CURRENT SUSTAIN LEVEL:=0
0900	9D BD 0A	1310	STA DESIRE+1,X	
0903	9D BE 0A	1320	STA CURSUS,X	
0906	9D BF 0A	1330	STA CURSUS+1,X	
0909	A9 FF	1340	DECR LDA #\$FF	DECREMENT TIME REMAINING
090B	DE A6 0A	1350	DEC TIME,X	
090E	DD A6 0A	1360	CMP TIME,X	
0911	D0 08	1370	BNE NEXTL	
0913	DE A7 0A	1380	DEC TIME+1,X	
0916	DD A7 0A	1390	CMP TIME+1,X	
0919	F0 15	1400	BEQ PROCES	BRANCH IF NO TIME LEFT
091B	8A	1410	NEXTL TXA	CONTINUE WITH
091C	18	1420	CLC	NEXT PART
091D	69 1A	1430	ADC #ASIZE	
091F	AA	1440	TAX	
0920	E6 02	1450	INC /COUNT	
0922	A5 02	1460	LDA /COUNT	
0924	C5 07	1470	CMP /PARNUM	
0926	D0 B7	1480	BNE LENGTH	
0928	2C 64 C0	1490	WAIT BIT \$C064	WAIT FOR TIMER
092B	30 FB	1500	BMI WAIT	
092D	4C 3C 08	1510	JMP MAIN	
0930		1520	* SONG DATA COMMAND PROCESSING SECTION	
0930	8A	1530	PROCES TXA	
0931	A8	1540	TAY	
0932	A5 02	1550	LDA /COUNT	
0934	0A	1560	ASL A	
0935	AA	1570	TAX	
0936	A1 08	1580	LDA (PARPNT,X)	GET COMMAND TYPE
0938	C9 CB	1590	CMP #203	
093A	D0 04	1600	BNE NOSTOP	BRANCH IF NOT "STOP"
093C		1610	* PROCESS STOP COMMAND	
093C	98	1620	TYA	DO NOTHING
093D	AA	1630	TAX	
093E	B0 DB	1640	BCS NEXTL	
0940	F6 08	1650	NOSTOP INC /PARPNT,X	
0942	D0 02	1660	BNE NOCAR1	
0944	F6 09	1670	INC /PARPNT+1,X	
0946	C9 C0	1680	NOCAR1 CMP #192	
0948	B0 57	1690	BCS NPITCH	BRANCH IF NOT "PITCH"
094A		1700	* PROCESS PITCH COMMAND	
094A	39 AB 0A	1710	AND TRANS+1,Y	
094D	79 AA 0A	1720	ADC TRANS,Y	
0950	86 04	1730	STX /TEMP2	COMPUTE DIVISOR
0952	A2 00	1740	LDX #0	DIVIDE PITCH BY 24
0954	C9 18	1750	DIV CMP #24	
0956	90 05	1760	BCC DIV1	
0958	E9 18	1770	SBC #24	
095A	E8	1780	INX	
095B	D0 F7	1790	BNE DIV	
095D	86 03	1800	DIV1 STX /TEMP1	

095F	0A		1810		ASL A	LOOK UP
0960	AA		1820		TAX	SUB-OCTAVE DIVISOR
0961	BD	76	0A	1830	LDA TABLE,X	
0964	85	05		1840	STA /TEMP3	
0966	BD	77	0A	1850	LDA TABLE+1,X	
0969	85	06		1860	STA /TEMP3+1	
096B	A6	03		1870	LDX /TEMP1	
096D	CA			1880	DEX	DIVIDE DIVISOR
096E	30	07		1890	BMI ROUND	TO RIGHT OCTAVE
0970	46	06		1900	LSR /TEMP3+1	
0972	66	05		1910	ROR /TEMP3	
0974	4C	6D	09	1920	JMP OCTAVE	
0977	90	06		1930	BCC SENDP	ROUND RESULT
0979	E6	05		1940	INC /TEMP3	
097B	D0	02		1950	BNE SENDP	
097D	E6	06		1960	INC /TEMP3+1	
097F	BE	B6	0A	1970	LDX CHAN,Y	SEND PITCH TO UNIT
0982	A5	05		1980	LDA /TEMP3	
0984	9D	84	C0	1990	STA \$C084,X	
0987	A5	06		2000	LDA /TEMP3+1	
0989	9D	84	C0	2010	STA \$C084,X	
098C	A2	06		2020	LDX #6	START "ADSR" CYCLE
098E	84	03		2030	STY /TEMP1	
0990	B9	AE	0A	2040	LDA DECAY,Y	
0993	99	BA	0A	2050	STA DOWN,Y	
0996	C8			2060	INY	
0997	CA			2070	DEX	
0998	D0	F6		2080	BNE CYCLE	
099A	A6	04		2090	LDX /TEMP2	
099C	A4	03		2100	LDY /TEMP1	STORE NOTE TIME
099E	4C	C3	09	2110	JMP STORD1	
09A1	D0	3B		2120	BNE NREST	BRANCH IF NOT "REST"
09A3				2130	* PROCESS REST COMMAND	
09A3	B9	B4	0A	2140	LDA RELEAS,Y	DO A "RELEASE"
09A6	99	BA	0A	2150	STA DOWN,Y	
09A9	B9	B5	0A	2160	LDA RELEAS+1,Y	
09AC	99	BB	0A	2170	STA DOWN+1,Y	
09AF	A9	00		2180	LDA #0	
09B1	99	BC	0A	2190	STA DESIRE,Y	
09B4	99	BD	0A	2200	STA DESIRE+1,Y	
09B7	99	BE	0A	2210	STA CURSUS,Y	
09BA	99	BF	0A	2220	STA CURSUS+1,Y	
09BD	18			2230	CLC	
09BE	84	03		2240	STY /TEMP1	STORE PARAMETER
09C0	65	03		2250	ADC /TEMP1	IN PARAMETER AREA
09C2	A8			2260	TAY	
09C3	A1	08		2270	LDA (PARPNT,X)	
09C5	99	A6	0A	2280	STA TIME,Y	
09C8	F6	08		2290	INC /PARPNT,X	
09CA	D0	02		2300	BNE NOCAR2	
09CC	F6	09		2310	INC /PARPNT+1,X	
09CE	A1	08		2320	LDA (PARPNT,X)	
09D0	99	A7	0A	2330	STA TIME+1,Y	
09D3	F6	08		2340	INC /PARPNT,X	
09D5	D0	02		2350	BNE NOCAR3	
09D7	F6	09		2360	INC /PARPNT+1,X	
09D9	A6	03		2370	LDX /TEMP1	
09DB	4C	09	09	2380	JMP DECR	
09DE	85	03		2390	STA /TEMP1	SET SO COMMAND
09E0	A9	00		2400	LDA #0	TAKES ZERO TIME
09E2	99	A6	0A	2410	STA TIME,Y	

09E5	99	A7	0A	2420	STA TIME+1,Y	
09E8	A5	03		2430	LDA /TEMP1	
09EA	C9	C9		2440	CMP #201	
09EC	B0	05		2450	BCS NSTORE	BRANCH IF NOT A
09EE	E9	BF		2460	SBC #191	STORED COMMAND
09F0	0A			2470	ASL A	
09F1	D0	CB		2480	BNE STORD	
09F3	84	03		2490	NSTORE STY /TEMP1	
09F5	D0	34		2500	BNE NOCALL	BRANCH IF NOT A "CALL"
09F7				2510	* PROCESS CALL COMMAND	
09F7	A1	08		2520	LDA (PARPNT,X)	COMPUTE CALLED ADDRESS
09F9	18			2530	CLC	
09FA	65	00		2540	ADC /SPNTR	
09FC	85	05		2550	STA /TEMP3	
09FE	F6	08		2560	INC /PARPNT,X	
0A00	D0	02		2570	BNE NOCAR4	
0A02	F6	09		2580	INC /PARPNT+1,X	
0A04	A1	08		2590	NOCAR4 LDA (PARPNT,X)	
0A06	65	01		2600	ADC /SPNTR+1	
0A08	85	06		2610	STA /TEMP3+1	
0A0A	8A			2620	TXA	STORE RETURN ADDRESS
0A0B	A8			2630	TAY	
0A0C	B5	08		2640	LDA /PARPNT,X	
0A0E	69	01		2650	ADC #1	
0A10	91	05		2660	STA (TEMP3),Y	
0A12	C8			2670	INY	
0A13	B5	09		2680	LDA /PARPNT+1,X	
0A15	69	00		2690	ADC #0	
0A17	91	05		2700	STA (TEMP3),Y	
0A19	A5	07		2710	LDA /PARNUM	ADVANCE CALLING
0A1B	0A			2720	ASL A	ADDRESS OVER
0A1C	65	05		2730	ADC /TEMP3	RETURN ADDRESSES
0A1E	95	08		2740	STA /PARPNT,X	
0A20	A5	06		2750	LDA /TEMP3+1	
0A22	69	00		2760	ADC #0	
0A24	95	09		2770	STA /PARPNT+1,X	
0A26	A6	03		2780	LDX /TEMP1	
0A28	4C	09	09	2790	JMP DECR	
0A2B	C9	CC		2800	NOCALL CMP #204	
0A2D	B0	22		2810	BCS NORET	BRANCH IF NOT "RETURN"
0A2F				2820	* PROCESS RETURN COMMAND	
0A2F	A1	08		2830	LDA (PARPNT,X)	COMPUTE RETURN ADDRESS
0A31	65	00		2840	ADC /SPNTR	ADDRESS
0A33	85	05		2850	STA /TEMP3	
0A35	F6	08		2860	INC /PARPNT,X	
0A37	D0	02		2870	BNE NOCAR5	
0A39	F6	09		2880	INC /PARPNT+1,X	
0A3B	A1	08		2890	NOCAR5 LDA (PARPNT,X)	
0A3D	65	01		2900	ADC /SPNTR+1	
0A3F	85	06		2910	STA /TEMP3+1	
0A41	8A			2920	TXA	GO TO
0A42	A8			2930	TAY	RETURN ADDRESS
0A43	B1	05		2940	LDA (TEMP3),Y	
0A45	95	08		2950	STA /PARPNT,X	
0A47	C8			2960	INY	
0A48	B1	05		2970	LDA (TEMP3),Y	
0A4A	95	09		2980	STA /PARPNT+1,X	
0A4C	A6	03		2990	LDX /TEMP1	
0A4E	4C	09	09	3000	JMP DECR	
0A51	D0	13		3010	NORET BNE NOTMPO	BRANCH IF NOT "TEMPO"
0A53				3020	* PROCESS TEMPO COMMAND	

```

0A53 A1 08 3030 LDA (PARPNT,X)
0A55 8D 3F 08 3040 STA PLACE1+1
0A58 F6 08 3050 INC /PARPNT,X
0A5A D0 02 3060 BNE NOCAR7
0A5C F6 09 3070 INC /PARPNT+1,X
0A5E A1 08 3080 NOCAR7 LDA (PARPNT,X)
0A60 8D 44 08 3090 STA PLACE2+1
0A63 4C D3 09 3100 JMP FIXUP
0A66 C9 FE 3110 NOTMPO CMP #254
0A68 B0 09 3120 BCS END BRANCH IF NOT A "NOP"
0A6A F6 08 3130 INC /PARPNT,X
0A6C D0 02 3140 BNE NOCAR6
0A6E F6 09 3150 INC /PARPNT+1,X
0A70 4C D3 09 3160 NOCAR6 JMP FIXUP
0A73 68 3170 END PLA "PROCESS" END COMMAND
0A74 AA 3180 TAX RESTORE X
0A75 60 3190 RTS AND RETURN
0A76 3200 * SUB-OCTAVE DIVISOR TABLE
0A76 20 FD 3210 TABLE DEF 64800
0A78 EB F5 3220 DEF 62955
0A7A EB EE 3230 DEF 61163
0A7C 1E E8 3240 DEF 59422
0A7E 82 E1 3250 DEF 57730
0A80 17 DB 3260 DEF 56087
0A82 DA D4 3270 DEF 54490
0A84 CB CE 3280 DEF 52939
0A86 E8 C8 3290 DEF 51432
0A88 30 C3 3300 DEF 49968
0A8A A1 BD 3310 DEF 48545
0A8C 3B B8 3320 DEF 47163
0A8E FD B2 3330 DEF 45821
0A90 E4 AD 3340 DEF 44516
0A92 F1 A8 3350 DEF 43249
0A94 22 A4 3360 DEF 42018
0A96 75 9F 3370 DEF 40821
0A98 EB 9A 3380 DEF 39659
0A9A 82 96 3390 DEF 38530
0A9C 39 92 3400 DEF 37433
0A9E 10 8E 3410 DEF 36368
0AA0 04 8A 3420 DEF 35332
0AA2 17 86 3430 DEF 34327
0AA4 45 82 3440 DEF 33349
0AA6 3450 * COMMAND PARAMETER AREA
0AA6 3460 TIME BSS 2 TIME REMAINING
0AA8 3470 GAP BSS 2 GAP SIZE
0AAA 3480 TRANS BSS 2 TRANSPOSE VALUE
0AAC 3490 ATTACK BSS 2 ATTACK RATE
0AAE 3500 DECAY BSS 6 DECAY RATE
0AB0 3510 VOLUME EQU DECAY+2 VOLUME LEVEL
0AB2 3520 SUSTAN EQU VOLUME+2 SUSTAIN LEVEL
0AB4 3530 RELEAS BSS 2 RELEASE RATE
0AB6 3540 CHAN BSS 2 CHANNEL NUMBER
0AB8 3550 LOUDNS BSS 2 CURRENT LOUDNESS
0ABA 3560 DOWN BSS 6 CURRENT DECAY RATE
0ABC 3570 DESIRE EQU DOWN+2 DESIRED LOUDNESS
0ABE 3580 CURSUS EQU DESIRE+2 CURRENT SUSTAIN LEVEL
001A 3590 ASIZE EQU *-TIME PARAMETER AREA SIZE
0AC0 3600 BSS ASIZE*8 OTHER 8 PARTS
0B90 3610 END

```

CHROMA (INTEGER VERSION)

```

0000      10      * CHROMA SUBROUTINE
0000      20      *
0000      30      * BY JOHN RIDGES
0000      40      *
0000      50      * ALF PRODUCTS INC.
0000      60      *
2000      70      ORG $2000
2000      80      * INTEGER BASIC LINE HEADER
2000      90      DAT LINE2-*
2001  AC  FF FF 100      DEF $FFFF
2003  5D      110      DAT $5D
2004      120      * PARAMETERS TO SUBROUTINES
2004  00      130      PITCH      DAT 0      FREQUENCY IN QUARTER STEPS
2005  00      140      CHAN      DAT 0      CHANNEL TO BE PROGRAMMED
2006  00      150      SLOT      DAT 0      SLOT OF UNIT TIMES 16
2007  00      160      OFFSET    DAT 0      QUARTER STEP OFFSET
2008  00      170      WIDTH     DAT 0      VARIABLE PULSE WIDTH
2009  00      180      DIVSRL    DAT 0      RESULT DIVISOR
200A  00      190      DIVSRH    DAT 0
200B      200      * ENTRY POINT FOR CHROMA SUBROUTINE
200B  18      210      CLC
200C  90 33   220      BCC ENTRY
200E      230      * ENTRY POINT FOR PULSE SUBROUTINE
200E  38      240      SEC
200F  B0 30   250      BCS ENTRY
2011      260      * QUARTER TONE DIVISOR TABLE
2011  20 FD   270      TABLE  DEF 64800
2013  EB F5   280      DEF 62955
2015  EB EE   290      DEF 61163
2017  1E E8   300      DEF 59422
2019  82 E1   310      DEF 57730
201B  17 DB   320      DEF 56087
201D  DA D4   330      DEF 54490
201F  CB CE   340      DEF 52939
2021  E8 C8   350      DEF 51432
2023  30 C3   360      DEF 49968
2025  A1 BD   370      DEF 48545
2027  3B B8   380      DEF 47163
2029  FD B2   390      DEF 45821
202B  E4 AD   400      DEF 44516
202D  F1 A8   410      DEF 43249
202F  22 A4   420      DEF 42018
2031  75 9F   430      DEF 40821
2033  EB 9A   440      DEF 39659
2035  82 96   450      DEF 38530
2037  39 92   460      DEF 37433
2039  10 8E   470      DEF 36368
203B  04 8A   480      DEF 35332
203D  17 86   490      DEF 34327
203F  45 82   500      DEF 33349
2041      510      * SET UP BASE ADDRESS FOR SUBROUTINES
2041  A9 00   520      ENTRY  LDA #0      SET TO LOW BYTE OF HIMEM
2043  85 54   530      STA /AUXL
2045  A9 00   540      LDA #0      SET TO HIGH BYTE OF HIMEM-2
2047  85 55   550      STA /AUXH
2049  8A      560      TXA      SAVE THE X REGISTER
204A  48      570      PHA
204B  90 4B   580      BCC CHROMA      EXECUTE DESIRED SUBROUTINE

```



```

204D          590  * COMPUTE XTNDL.ACH:=(DIVSR*(WIDTH+1))/256
204D  A0 B4    600  PULSE  LDY #REF+WIDTH
204F  A2 FE    610          LDX #-2          STORE WIDTH IN XTNDL
2051  B1 54    620  PULSE0  LDA (AUXL),Y          AND DIVSRL IN XTNDH
2053  95 54    630          STA /XTNDL+2,X
2055  C8      640          INY
2056  E8      650          INX
2057  D0 F8    660          BNE PULSE0
2059  B1 54    670          LDA (AUXL),Y          STORE DIVSRH IN ACL
205B  85 50    680          STA /ACL
205D  86 51    690          STX /ACH          CLEAR ACH
205F  A2 08    700          LDX #8          XTNDL.ACH.ACL:=(DIVSR*XTNDL)
2061  06 53    710  PULSE1  ASL /XTNDH          +ACH.ACL.XTNDH
2063  26 50    720          ROL /ACL
2065  26 51    730          ROL /ACH
2067  26 52    740          ROL /XTNDL
2069  90 13    750          BCC PULSE2
206B  18      760          CLC
206C  88      770          DEY
206D  B1 54    780          LDA (AUXL),Y
206F  65 50    790          ADC /ACL
2071  85 50    800          STA /ACL
2073  C8      810          INY
2074  B1 54    820          LDA (AUXL),Y
2076  65 51    830          ADC /ACH
2078  85 51    840          STA /ACH
207A  90 02    850          BCC PULSE2
207C  E6 52    860          INC /XTNDL
207E  CA      870  PULSE2  DEX
207F  D0 E0    880          BNE PULSE1
2081  A0 B1    890          LDY #REF+CHAN
2083  B1 54    900          LDA (AUXL),Y
2085  30 0E    910          BMI PULSE3          BRANCH IF NO-SEND FLAG SET
2087  C8      920          INY          OR IN SLOT TO
2088  11 54    930          ORA (AUXL),Y          FORM UNIT ADDRESS
208A  AA      940          TAX
208B  A5 51    950          LDA /ACH          SEND XTNDL.ACH TO UNIT
208D  9D 84 C0 960          STA $C084,X
2090  A5 52    970          LDA /XTNDL
2092  9D 84 C0 980          STA $C084,X
2095  68      990  PULSE3  PLA          RESTORE X AND RETURN
2096  AA     1000          TAX
2097  60     1010          RTS
2098  A0 B0    1020  CHROMA  LDY #REF+PITCH
209A  B1 54    1030          LDA (AUXL),Y          DIVIDE PITCH BY 24 TO GET
209C  A2 00    1040          LDX #0          A:=SUBOCTAVE
209E  C9 18    1050  CHROM1  CMP #24          X:=OCTAVE
20A0  90 0E    1060          BCC CHROM2
20A2  E9 18    1070          SBC #24
20A4  E8     1080          INX
20A5  D0 F7    1090          BNE CHROM1
20A7          1100  * LINE ONE TRAILER
20A7  5D 5D    1110          DEF $5D5D
20A9  5D 5D    1120          DEF $5D5D
20AB  01     1130          DAT 1
20AC          1140  * LINE 2 HEADER
20AC  A8     1150  LINE2  DAT LINE3-*
20AD  FF FF    1160          DEF $FFFF
20AF  5D     1170          DAT $5D
20B0          1180  * BACK TO CHROMA
20B0  0A     1190  CHROM2  ASL A          GET THE PROPER DIVISOR

```

20B1	69	BE	1200	ADC #REF+TABLE+1	FROM THE TABLE
20B3	A8		1210	TAY	
20B4	B1	54	1220	LDA (AUXL),Y	
20B6	85	51	1230	STA /ACH	
20B8	88		1240	DEY	
20B9	B1	54	1250	LDA (AUXL),Y	
20BB	CA		1260	DEX	DIVISOR:=DIVISOR/(2^OCTAVE)
20BC	30	06	1270	BMI CHROM4	
20BE	46	51	1280	LSR /ACH	
20C0	6A		1290	ROR A	
20C1	CA		1300	DEX	
20C2	10	FA	1310	BPL CHROM3	
20C4	69	00	1320	ADC #0	ROUND THE RESULT
20C6	90	02	1330	BCC CHROM5	
20C8	E6	51	1340	INC /ACH	
20CA	A0	B5	1350	LDY #REF+DIVSRL	
20CC	91	54	1360	STA (AUXL),Y	STORE THE RESULT
20CE	C8		1370	INY	IN DIVSR
20CF	A5	51	1380	LDA /ACH	
20D1	91	54	1390	STA (AUXL),Y	
20D3	A0	B3	1400	LDY #REF+OFFSET	
20D5	B1	54	1410	LDA (AUXL),Y	
20D7	F0	5A	1420	BEQ CHROM0	BRANCH IF NO OFFSET
20D9			1430	* COMPUTE DIVSR:=DIVSR-(DIVSR*OFFSET)/8993	
20D9	85	52	1440	STA /XTNDL	SAVE OFFSET
20DB	E8		1450	INX	CLEAR XTNDH, ACL, AND ACH
20DC	86	53	1460	STX /XTNDH	
20DE	86	50	1470	STX /ACL	
20E0	86	51	1480	STX /ACH	
20E2	A2	08	1490	LDX #8	XTNDL.ACH.ACL:=(DIVSR*XTNDL)
20E4	A0	B5	1500	LDY #REF+DIVSRL	+ACH.ACL*256
20E6	06	50	1510	ASL /ACL	
20E8	26	51	1520	ROL /ACH	
20EA	26	52	1530	ROL /XTNDL	
20EC	90	13	1540	BCC CHROM7	
20EE	18		1550	CLC	
20EF	B1	54	1560	LDA (AUXL),Y	
20F1	65	50	1570	ADC /ACL	
20F3	85	50	1580	STA /ACL	
20F5	C8		1590	INY	
20F6	B1	54	1600	LDA (AUXL),Y	
20F8	65	51	1610	ADC /ACH	
20FA	85	51	1620	STA /ACH	
20FC	88		1630	DEY	
20FD	90	02	1640	BCC CHROM7	
20FF	E6	52	1650	INC /XTNDL	
2101	CA		1660	DEX	
2102	D0	E2	1670	BNE CHROM6	
2104	A0	10	1680	LDY #16	AC:=XTND.AC/8993
2106	06	50	1690	ASL /ACL	XTND:=XTND.AC MOD 8993
2108	26	51	1700	ROL /ACH	
210A	26	52	1710	ROL /XTNDL	
210C	26	53	1720	ROL /XTNDH	
210E	38		1730	SEC	
210F	A5	52	1740	LDA /XTNDL	
2111	E9	21	1750	SBC #33	
2113	AA		1760	TAX	
2114	A5	53	1770	LDA /XTNDH	
2116	E9	23	1780	SBC #35	
2118	90	06	1790	BCC CHROM9	
211A	86	52	1800	STX /XTNDL	

```

211C 85 53      1810      STA /XTNDH
211E E6 50      1820      INC /ACL
2120 88        1830      DEY      CHROM9
2121 D0 E3      1840      BNE CHROM8
2123 A0 B5      1850      LDY #REF+DIVSRL
2125 B1 54      1860      LDA (AUXL),Y      DIVSR:=DIVSR-AC
2127 38        1870      SEC
2128 E5 50      1880      SBC /ACL
212A 91 54      1890      STA (AUXL),Y
212C C8        1900      INY
212D B1 54      1910      LDA (AUXL),Y
212F E5 51      1920      SBC /ACH
2131 91 54      1930      STA (AUXL),Y
2133 A0 B1      1940      LDY #REF+CHAN      CHROM0
2135 B1 54      1950      LDA (AUXL),Y
2137 30 11      1960      BMI CHROM:      BRANCH IF NO-SEND FLAG SET
2139 C8        1970      INY      OR IN SLOT TO
213A 11 54      1980      ORA (AUXL),Y      FORM UNIT ADDRESS
213C AA        1990      TAX
213D A0 B5      2000      LDY #REF+DIVSRL
213F B1 54      2010      LDA (AUXL),Y      SEND DIVISOR TO UNIT
2141 9D 84 C0   2020      STA $C084,X
2144 C8        2030      INY
2145 B1 54      2040      LDA (AUXL),Y
2147 9D 84 C0   2050      STA $C084,X
214A 68        2060      CHROM: PLA      RESTORE X AND RETURN
214B AA        2070      TAX
214C 60        2080      RTS
214D          2090      * LINE 2 TRAILER
214D 5D 5D      2100      DEF $5D5D
214F 5D        2110      DAT $5D
2150 C1 CC      2120      DEF $CCC1
2152 C6 01      2130      DEF $1C6
2154          2140      LINE3 EQU *
E0AC          2150      REF EQU 512-*      HIMEM LOCATION REFERENCE
2154          2160      * ON BASE PAGE
0050          2170      ACL EQU $50
0051          2180      ACH EQU $51
0052          2190      XTNDL EQU $52
0053          2200      XTNDH EQU XTNDL+1
0054          2210      AUXL EQU $54
0055          2220      AUXH EQU AUXL+1
2154          2230      END

```

INDEX

- ***DISK, in ENTRY: 3-31
- *, in ENTRY: 3-3, 3-4
- ., in ENTRY: 3-6, 3-8, 3-36
- 3, in ENTRY: 3-17 to 3-18, 3-36
- Access socket: 11-3, 11-4 to 11-5, 11-7
- ALBUM file: 5-1 to 5-2
- "America": 3-2, 3-5, 3-10, 3-11
- Applesoft: 1-3, 2-2, 3-1, 3-40, 4-1, 4-2, 6-1, 6-2, 6-4 to 6-5, 6-6, 6-13, 7-2, 7-3, 7-5
- Asterisk, in ENTRY: 3-3, 3-4
- ATTACK, in ENTRY: 3-22, 3-24 to 3-26, 3-36
- ATTACK RATE, in PERFORM: 6-11, 6-14, 6-15
- Audio cable: 1-1 to 1-2
- Audio outputs: 11-3, 11-6
- Cable: 1-1 to 1-2
- CALL, in ENTRY: 3-18 to 3-20, 3-36 to 3-37
- CALL, in PERFORM: 6-9 to 6-10, 6-13, 6-14, 6-17
- CHANNEL NUMBER, in PERFORM: 6-9, 6-12, 6-14
- CHROMA program: 2-3, 7, 10-7 to 10-10
- CHROMA variable: 7-1
- Circuit card: 11-9
- Command numbers, in PERFORM: 6-14
- Commands, in ENTRY: 3-28 to 3-38
- Commands, Type 1, in ENTRY: 3-28 to 3-31
- Commands, Type 2, in ENTRY: 3-31 to 3-34
- Commands, Type 3, in ENTRY: 3-34 to 3-35
- Commands, Type 4, in ENTRY: 3-35 to 3-38
- Commands, Type A, in PERFORM: 6-9 to 6-10
- Commands, Type B, in PERFORM: 6-10 to 6-11
- Commands, Type C, in PERFORM: 6-11
- Connection, Timing Mode: 9-1 to 9-2
- Connector locations: 11-7
- Copying songs with ENTRY: 3-40
- Configuration, song: 6-6
- Correcting mistakes, in ENTRY: 3-12
- CURRENT DECAY: 3-23 to 3-24, 6-11, 6-15 to 6-17
- CURRENT LOUDNESS: 3-23 to 3-24, 6-11, 6-15
- CURRENT SUSTAIN LEVEL: 3-23 to 3-24, 6-11, 6-15 to 6-17
- Cursor, in ENTRY: 3-2 to 3-8, 3-15
- DECAY, in ENTRY: 3-22, 3-24 to 3-26, 3-37
- DECAY RATE, in PERFORM: 6-11, 6-14, 6-17
- DEL, in ENTRY: 3-13 to 3-14, 3-31
- DELETE, in ENTRY: 3-31 to 3-32
- DESIRED LOUDNESS: 3-23 to 3-24, 6-11, 6-15 to 6-17
- Dimensions, board: 11-8
- DISCO: 2-3, 5
- Divisor calculation: 8-4
- Dot, in ENTRY: 3-6, 3-8, 3-36
- EDIT, in ENTRY: 3-9, 3-11, 3-15, 3-32, 3-34
- END, in ENTRY: 3-4, 3-5
- END, in PERFORM: 6-10, 6-12, 6-14, 6-17
- Entering a simple song, in ENTRY: 3-1
- Entering rests, in ENTRY: 3-15
- ENTRY program: 2-3, 3
- Envelopes, in ENTRY: 3-22 to 3-26
- Enveology: 3-23
- Flat, in ENTRY: 3-29, 3-36
- GAP, in ENTRY: 3-22 to 3-26, 3-37
- GAP SIZE, in PERFORM: 6-10 to 6-11, 6-14, 6-15
- GOTO, in ENTRY: 3-29 to 3-30
- Initialization, synthesizer: 6-6, 8-1 to 8-2
- INITIALIZER, in CHROMA: 7-1 to 7-2
- Insert, in ENTRY: 3-5, 3-14, 3-29
- Installation: 1
- INTEGER, in ENTRY: 3-30, 3-40
- Introduction: 2
- INTRODUCTION program: 2-2

KEY, in ENTRY: 3-2, 3-7, 3-17, 3-19,
3-34 to 3-36, 3-41

Left movement, in ENTRY: 3-29
LENGTH, in ENTRY: 3-21, 3-30, 3-36
LOAD, in ENTRY: 3-19 to 3-20, 3-32
LOAD, in PLAY: 4-1

MEASURE, in ENTRY: 3-30
Measure bars, in ENTRY: 3-6, 3-15, 3-22
Menu paddle, in ENTRY: 3-3 to 3-9, 3-28
to 3-29, 3-31, 3-35 to 3-36
Mnemonic variable names, in CHROMA: 7-2
Monitor: 3-1
"Music Notation": 3-26

Natural, in ENTRY: 3-29, 3-36
NEW, in ENTRY: 3-2, 3-15, 3-32 to 3-33
Note duration symbols, in ENTRY: 3-28 to
3-29, 3-36
Note paddle, in ENTRY: 3-3, 3-5 to 3-8,
3-36
Notetrinos: 3-24

OFFSET, in CHROMA: 7-4
Operating tips: 1-4

Paddle 0: see menu paddle
Paddle 1: see note paddle
Paramatron, high power: 3-24
PART, in CHROMA: 7-1, 7-3, 7-5
PART, in ENTRY: 3-9, 3-11, 3-27, 3-30
Part data: 6-12
PARTIAL INITIALIZER, in CHROMA: 7-2 to
7-3
Partial starting measure: 3-39
PERFORM program: 2-3, 6, 10-1 to 10-6
PITCH, in CHROMA: 7-1, 7-3 to 7-4
PITCH+2: 7-1, 7-3, 7-5
PITCH+5 & PITCH+6: 7-1, 7-5
PITCH, in PERFORM: 6-11, 6-14, 6-17
PLAY, in ENTRY: 3-8 to 3-12, 3-18, 3-20
3-30 to 3-31
PLAY, in PLAY: 4-1
PLAY program: 2-3, 4
POKE, in ENTRY: 3-37
Ports: 8-1 to 8-3
Ports 0 to 2: 8-1
Ports 3 & 7: 8-1 to 8-2
Ports 4 to 6: 8-2 to 8-3
Problem checklist: 1-5
PULSE: 7, 7-1, 7-5

QUARTER, in ENTRY: 3-20 to 3-21, 3-22,
3-35, 3-36, 3-39, 3-41
Reading, recommended: 3-26
Recommended reading: 3-26
Relative addresses: 6-11 to 6-12
RELEASE, in ENTRY: 3-22, 3-24 to 3-27,
3-37
RELEASE RATE, in PERFORM: 6-11, 6-14,
6-16 to 6-17
Repair: 1-4
Repeated sections: 3-17
Reset: 3-19, 3-40, 4-2
REST, in ENTRY: 3-15 to 3-17, 3-35,
3-39
REST, in PERFORM: 6-11, 6-14
RETURN, in PERFORM: 6-10, 6-13, 6-14,
6-17

Right movement, in ENTRY: 3-4, 3-29
"Row, Row, Row your Boat": 3-17

SAVE, in ENTRY: 3-20, 3-31
Schematic: 11-4 to 11-6
Selected hex addresses, in ENTRY: 3-41
Session, sample, in PERFORM: 6-7 to 6-8
Sharp, in ENTRY: 3-12, 3-29, 3-36
Signal descriptions: 11-2
SLOT & UNITS: 1-3, 2-2, 3-1, 4-1, 6-6,
6-7, 6-8, 6-10, 7-1, 7-2, 7-6, 8-1
Song breakdown: 3-27
Song data, in PERFORM: 6-11 to 6-13
Song data format, in ENTRY: 3-41
Speaker/arrow, in ENTRY: 3-8, 3-29
SPEED, in ENTRY: 3-15, 3-21, 3-22, 3-33
Start of data: 6-12
STEREO, in ENTRY: 3-15, 3-33 to 3-34,
9-2
Stereo, standard, in ENTRY: 3-32
STOP, in PLAY: 4-1 to 4-2
STOP, in PERFORM: 6-10, 6-12, 6-14,
6-16
SUBROUTINE, in ENTRY: 3-17 to 3-20,
3-34
Subroutine data: 6-12 to 6-13, 6-14
Suggested speed, reading: 6-6 to 6-7
Summary of commands, in ENTRY: 3-28 to
3-38
SUSTAIN, in ENTRY: 3-22, 3-24, 3-26,
3-37
SUSTAIN LEVEL, in PERFORM: 6-11, 6-14,
6-17

Television: 3-1
TEMPO, in ENTRY: 3-37
Tempo, in ENTRY: 3-20 to 3-21
TEMPO, in PERFORM: 6-13, 6-14, 6-17,
9-2
Tempo, in PERFORM: 6-7
Temporaries, in PERFORM: 6-13
TIE, in ENTRY: 3-14 to 3-16, 3-36
TIME, in ENTRY: 3-3, 3-6, 3-17, 3-35,
3-39, 3-41
Time periods: 3-5, 3-6, 3-20 to 3-21,
3-37, 3-39, 6-13
Timing mode: 9
Timing requirements, electronic: 11-1
Tips, for ENTRY: 3-39
TRANSPOSE, in ENTRY: 3-18 to 3-19,
3-38, 3-40, 3-41
TRANSPOSE, in PERFORM: 6-10, 6-14
Triplets, in ENTRY: 3-17 to 3-18, 3-36
TSLOT: 3-1, 4-1, 6-8, 9-2
TTL input requirements: 11-3
Tuning: 8-5

UNITS: see SLOT & UNITS

<value>, in ENTRY: 3-35
VOL \emptyset , in CHROMA: 7-2
VOLUME, in ENTRY: 3-22, 3-24, 3-26,
3-38
VOLUME LEVEL, in PERFORM: 6-11, 6-14,
6-17

WIDTH, in CHROMA: 7-1, 7-5

X notes, in ENTRY: 3-21

SIGNAL DESCRIPTIONS

Pin	Name	Desc.
2	A \emptyset	Address line \emptyset . 1 LS TTL load.
3	A1	" " 1. 1 LS TTL load.
4	A2	" " 2. 2 LS TTL loads.
18	R/ \overline{W}	Read/ $\overline{\text{Write}}$. 1 LS TTL load.
23	INT OUT	Connected to pin 28.
24	DMA OUT	Connected to pin 27.
25	+5V	+5 volts, \pm 5%. 13 \emptyset mA typical, 215 mA max.
26	GND	Signal ground.
27	DMA IN	Connected to pin 24.
28	INT IN	Connected to pin 23.
33	-12V	-18 volts to -1 \emptyset .8 volts. 2 \emptyset mA typical, 3 \emptyset mA max.
41	$\overline{\text{DEV SEL}}$	Board enable. 2 LS TTL loads.
42	D7	Data bus bit 7. 1 LS TTL load.
43	D6	" " " 6. 1 LS TTL load.
44	D5	" " " 5. 1 LS TTL load.
45	D4	" " " 4. 1 LS TTL load.
46	D3	" " " 3. 1 LS TTL load.
47	D2	" " " 2. 1 LS TTL load.
48	D1	" " " 1. 1 LS TTL load.
49	D \emptyset	" " " \emptyset . 1 LS TTL load.
5 \emptyset	+12V	+1 \emptyset volts to +18 volts. 25 mA typical, 35 mA max.

Supply voltages (+5V, -12V, and +12V) should be regulated.

A4 ACCESS SOCKET

Pin	Name	Desc.
1	+12	Connected to +12 volts.
2	NC	
3	OUT \emptyset	TTL output of channel \emptyset . Drives 3 LS loads.
4	OUT1	" " " " 1. Drives 3 LS loads.
5	OUT2	" " " " 2. Drives 1 LS load.
6	NC	
7	-12	Connected to -12 volts.
8	GND	Signal ground.
9	NC	
1 \emptyset	NC	
11	AUD	Audio out. Source/sink 6.5 mA max. 2.25 to 7.25 volts.
12	NC	
13	NC	
14	+5	Connected to +5 volts.

TTL INPUT REQUIREMENTS

	MIN	MAX
High Level Input Voltage	2 volts	5.5 volts
Low Level Input Voltage	\emptyset volts	$\emptyset.8$ volts

1 LS load = 2 \emptyset uA at 2.7 volts input and - $\emptyset.4$ mA at $\emptyset.4$ volts input.

AUDIO OUTPUTS

Impedance: 7 $\emptyset\emptyset$ ohms typical. Output: $\emptyset.91$ volts peak.

SCHEMATIC TERMINALS

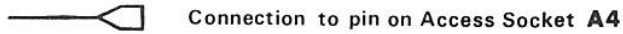
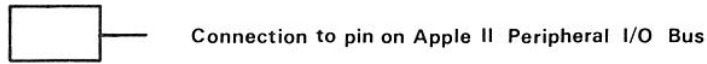

Boldface characters on schematic (eg. **C2**) refer to component locations.
See silkscreen artwork for locations.

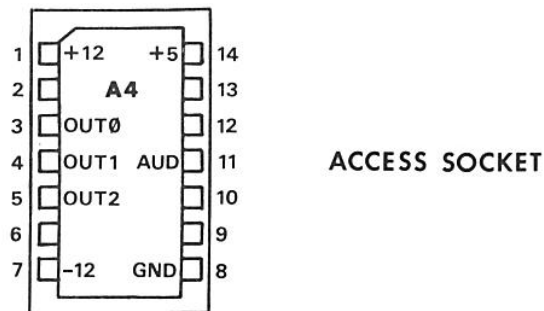

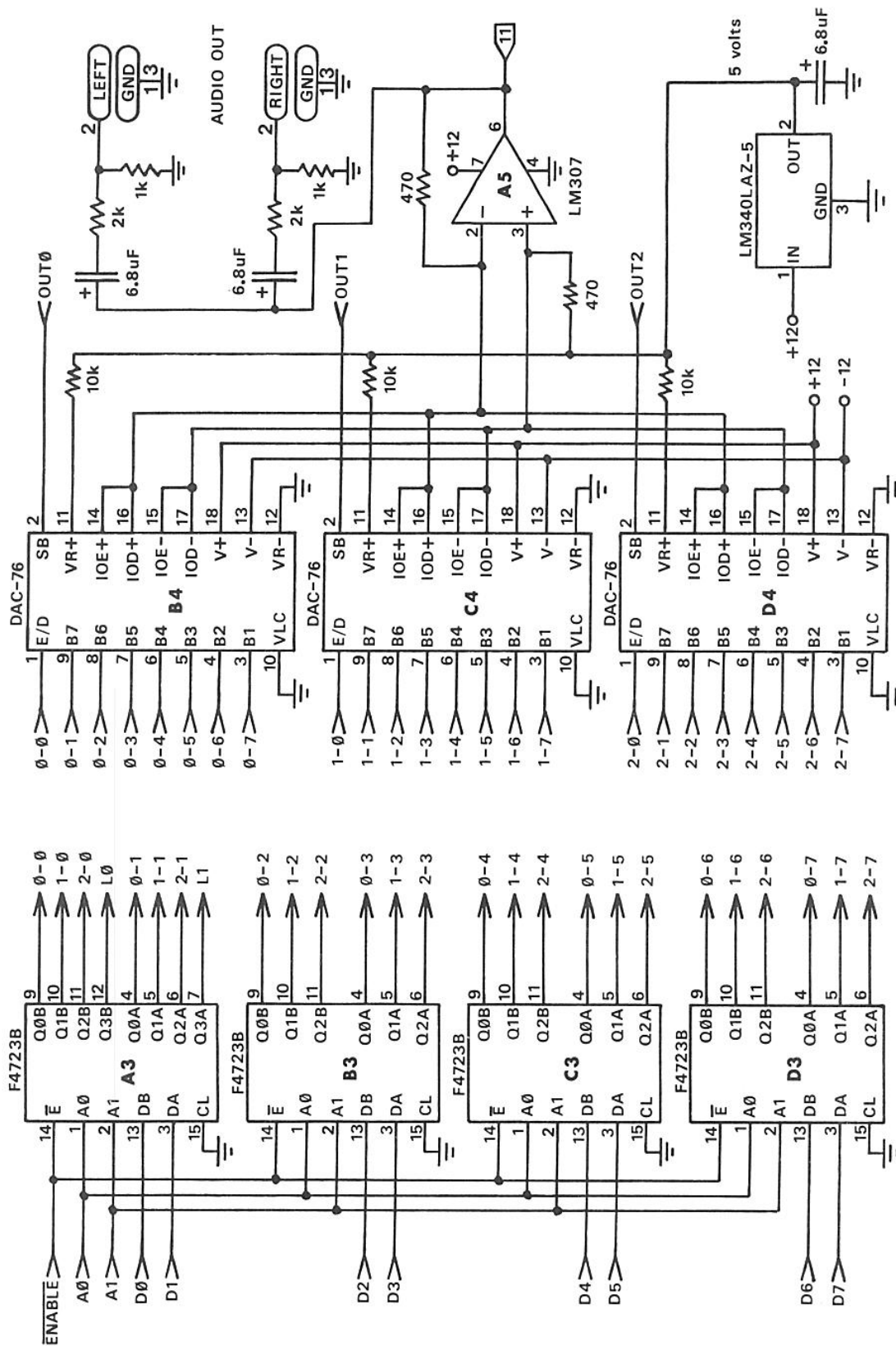

Note: IC's B4, C4, and D4 are powered from +12V and -12V; A5 is powered from +12V; all others are powered from +5V.

CONNECTOR LOCATIONS

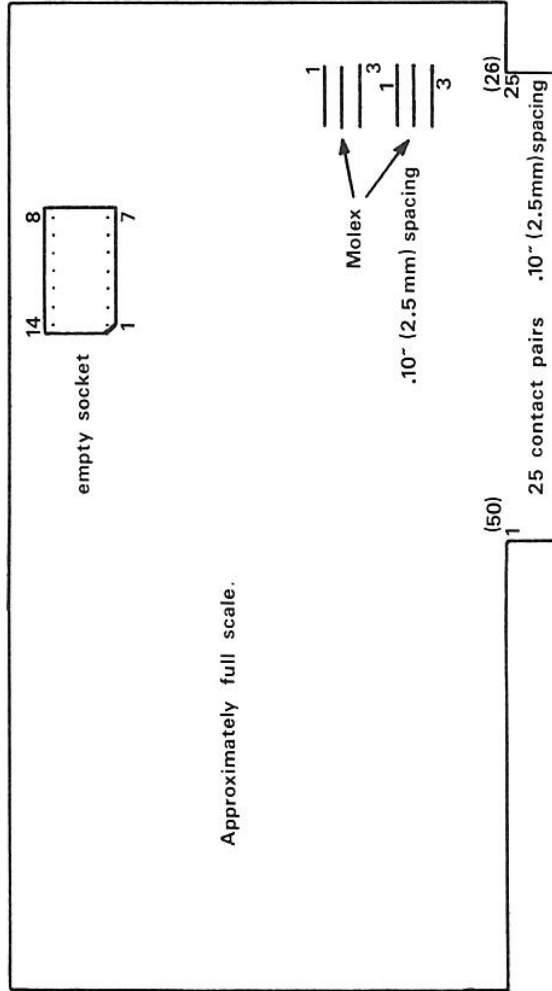

Note: Edge contact mates with Winchester HW25C or equivalent. (Supplied in Apple II.)

DIMENSIONS

